

APPENDICES

Non-Wires Alternative Reports	A
System Planning Studies	B
Proposed Reliability Projects	C
Initial Funding Request Forms – System Planning	D
Solution Selection Forms – System Planning	E
Project Authorization Forms – Distribution Line	F



Non-Wires Alternative Framework

VERSION 2.0

Primary Contact:

Gerhard Walker

gerhard.walker@eversource.com

CONTENTS

1. Tables and Figures 5

2. Abbreviations 6

3. Introduction 1

4. Stakeholders 2

5. Initial NWA Screening 3

A. Critical Suitability Criteria 3

B. Additional Considerations 3

6. General Framework 4

A. Considered Resources 4

B. Forecasting and Planning Horizons 5

System forecast Horizon 5

Financial Planning Horizon 5

Terminal Cost 5

Deferring Capacity Need 6

C. NWA Dispatch Options 6

7. Reliability Model 8

A. EXEMPTIONS FROM the N-1 Reliability DESIGN STANDARD 8

B. Reliability Assumptions for Customer Programs 8

C. Reliability Assumptions for Grid Scale Batteries 9

D. Reliability Assumptions for DG 9

8. Dispatch Model 10

A. Prioritization of DER Dispatch 10

B. Solar Generation 10

C. Energy Efficiency 12

D. Demand Response 14

Snap Back and Pre-Conditioning 14

Availability of DR Resources 15

E. Conservation Voltage Reduction 17

F. Battery Storage 17

G. Fuel Cell 18

H. Combined Heat and Power 18

I. Emergency Generation 18

9.	Cost Model	19
A.	Traditional Solution.....	19
B.	NWA Cost Types.....	19
C.	Annual Rates of Change	21
D.	Earning Factors Utility Programs.....	22
E.	Life Cycle Assumptions.....	22
F.	Solar Generation	23
	Utility Scale Solar Generation.....	23
	Behind the Meter Solar Generation:.....	24
G.	Energy Efficiency	24
H.	Demand Resonse	25
	Commerical	25
	Residential.....	26
	Storage	27
I.	Conservation Voltage Reduction.....	27
J.	Battery Storage	27
K.	Fuel Cell.....	28
L.	Combined Heat and Power	28
M.	Emergency Generation	29
10.	Revenue Requirements.....	30
A.	General Assumptions	30
	Accounts.....	30
	Depreciation Accrual Rate.....	30
	PRE-TAX WACC.....	30
	Property Purchases	31
	Program Cost.....	31
	O&M Cost.....	31
	AsseT Revenue	31
B.	MACRS.....	31
	MACRS 7 Years (363 - Storage Battery Equipment)	31
	MACRS 5 Years (344/345 - Solar Panels, Inverters, Generators)	31
	MACRS 20 Years (344/345 - Solar Panels, Inverters, Generators)	32
C.	assumptions by entity	32
11.	Revenue Estimation Model	33

A.	Regional Network Service (RNS) and Local Network Service (LNS):	33
B.	ISO Registration Model	33
C.	ISO Market Participation	35
D.	ISO Market Assumptions.....	36
	Real-Time and DAY Ahead Market (Wholesale Energy)	36
	Forward Capacity Market (FCM)	36
E.	DER Revenue Timelines.....	36
F.	DER Revenue	37
	Solar PV	37
	Energy Efficiency	37
	Demand Response.....	38
	Conservation Voltage reduction	38
	Battery Storage	38
	Fuel Cell & CHP	39
	Emergency Generation.....	39

1. TABLES AND FIGURES

Table 1: DER Technologies Considered as NWA 4

Table 2: Saturated Reliability Factor for Utility Programs 9

Table 3: Application of Annual Change Rates Based on Cost Component 21

Table 4: Program Performance Incentive 22

Table 5: Life Cycle Assumptions by Asset Type 22

Table 6: 7 Year MARCS 31

Table 7: 5 Year MARCS 31

Table 8: 20 Year MARCS 32

Table 9: Applicable Energy Market Revenue Models by Type of DER 35

Figure 1: Financial Timelines in NWA Framework 6

Figure 2: Application of Minimal Weather Adjusted Solar Generation Capacity to a Capacity Deficit 12

Figure 3: Daily Lighting EE Profile 13

Figure 4: Annual Commercial HVAC EE Profile 13

Figure 5: Daily Profile for Commercial HVAC EE 14

Figure 6: HVAC Residential HVAC EE Profile 14

Figure 7: Example DR Event with Pre-Conditioning and Snap Back 15

Figure 8: Annual DR Capacity Availability Profile 16

Figure 9: Available DR Capacity Profile 16

2. ABBREVIATIONS

BESS:	Battery Energy Storage System
BTM:	Behind the Meter
CHP:	Combined Heat and Power
CPR:	Clean Power Research
CVR:	Conservation Voltage Reduction
DER:	Distributed Energy Resource
DG:	Distributed Generation
DR:	Demand Response
EE:	Energy Efficiency
EG:	Emergency Generation
ENST:	Eversource NWA Screening Tool
EV:	Electric Vehicle
FC:	Fuel Cell
LR:	Load Reducer
MARCS:	Modified Accelerated Cost Recovery System
MG:	Modelled Generation
NWA:	Non-Wires Alternative
PV:	Photovoltaics
SOG:	Settlement Only Generation

3. INTRODUCTION

As part of Docket No. 17-12-03RE07¹, PURA Investigation into Distribution System Planning of the Electric Distribution Companies – Non-Wires Alternative, Eversource submitted a Written Comments outlining a Non-Wires Alternatives (NWA) Screening Process. Within this process, Eversource identified three (3) main Phases;

- a. Technology Screening and Approval
- b. NWA Screening Process Per Identified Need
- c. Vendor Qualification and Solution Deployment

In Phase II, Eversource calls for a system wide screening of NWA opportunities based on an NWA Screening Tool. This NWA Screening Tool is an Eversource internal development which allows Eversource System Planning to screen capacity project needs at specific locations for potential application of NWA solutions. The intention being, that only sites that are suitable and viable for NWA solutions will move to a more detailed, engineering analysis stage.

The Eversource NWA Screening Tool is designed to enable rapid initial screening of NWA options against traditional system upgrade projects. The NWA Screening Tool will also provide appropriate sizing of such solutions. The objective of the tool is not to provide detailed and accurate costing or technical solution design, but rather to provide a quick, repeatable, scalable process for initial screening of NWA options using leveled cost estimates and basic technical assumptions. To enable this rapid screening, the NWA Screening Tool uses leveled values and standard assumptions for costing of solutions. Furthermore, the NWA Screening Tool only focuses on deferring station capital upgrades and does not incorporate a power flow engine, but rather uses substation load forecasts. Once an NWA solution passes the NWA Screening Tool as a viable solution, Eversource System Planning will still need to perform detailed steady-state and transient analysis studies as well as develop engineering designs and cost estimates for the identified solution at a specific location. And this stage, it is still possible that an NWA solution fails to proceed due to technical issues or cost constraints.

To guide a successfully development of the NWA Screening Tool and screening analysis, Eversource developed this NWA Framework. The NWA Framework describes all the assumptions applicable to the NWA Screening Process. This document represents the Eversource NWA Framework. Within the NWA Framework the following key topics are discussed:

- | | |
|---------------------------------------|---|
| a. General Assumptions: | Provides an overview of the general assumptions made in the screening process |
| b. Reliability Model: | Details how the reliability of NWAs is modeled within the NWA Screening Tool. |
| c. Dispatch Model: | Describes dispatch and technical modeling of DERs within an NWA Solution |
| d. Cost Model: | Highlights the cost parameters that are used to determine cost of solutions |
| e. Revenue Requirements Model: | Provides information on revenue requirements calculations conducted |
| f. Revenue Estimation Model: | identifies revenue streams that could be captured by DERs in NWA Solutions |

1

4. STAKEHOLDERS

32

33

34 ▪ **Lead Developer and Coordinator**

Gerhard Walker

35

36 ▪ **Subject Matter Experts**

37 ○ Regulatory Finance

Brian Rice

38

Conner Eller

39 ○ Energy Efficiency

Mike Goldman

40

Roshan Bhakta

41

Brian Greenfield

42 ○ Grid Mod

Steven Casey

43 ○ Market Participation

David Errichetti

44 ○ Reliability and Asset Health Index:

Jaydeep Deshpande

45 ○ Distribution Planning

Juan Martinez

46

47 ▪ **Reviewers**

48 ○ Distribution Planning MA

Juan Martinez

49 ○ Distribution Planning CT

Dalia Nunes

50 ○ Distribution Planning NH

Matthew Cosgro

51 ○ DER Planning MA

Shakir Iqbal

52 ○ DER Planning CT

Dave Ferrante

53 ○ DER Planning NH

Richard Labrecque

54 ○ Transmission Planning

Janny Dong

55

Joe Adadjo

56 ○ Grid Modernization

Ben Byboth

57 ○ ISO Policy & Economic Analysis

David Burnham

58

Andrew Tan

59

60 ▪ **Director/Executive Review**

61 ○ Distribution Planning

Lavelle Freeman

62 ○ Transmission Planning

Jacob Lucas

63 ○ System Planning

Digaunto Chatterjee

64 ○ Grid Modernization

Jennifer Schilling

65 ○ Engineering

Aftab Khan

66

67 **5. INITIAL NWA SCREENING**

68 The NWA Framework calls for an initial screening to ensure that from a practical and company policy standpoint the project
69 does not pose any insurmountable obstacles for an NWA Solution before further analysis has been conducted.

70 **A. CRITICAL SUITABILITY CRITERIA**

71 The Critical Suitability Criteria pose a go-no-go decision point in the NWA Screening Process.

- 72 a. **Asset Health Index < 0.5:** Any station with a transformer’s asset health index above 0.5 will not be considered as an NWA
73 candidate. A health index greater than 0.5 equals a turn insulation drop below 400. (new transformers are at ~1000).
74 Industry/literature² accepted practice is that <400 is a replacement candidate.
- 75 b. **Year of First Violation ≥ 2:** Any constraint that appears with 2 or less years from the base year will not be considered for
76 an NWA option, as the timeframes for solution design and procurement would not suffice. A standard, out of the box
77 traditional solution provides a faster, and safer alternative to address the issues.

78 Any project site that does not pass all three criteria will be disqualified from further NWA considerations and Eversource will
79 move forward with developing a traditional solution.

80 **B. ADDITIONAL CONSIDERATIONS**

81 The additional screening considerations are intended to help guide a discussion in case the final cost benefit is close to 1. If any
82 of the additional considerations is answered with a “No”, a decision against the NWA solution might be made, but needs to be
83 evaluated on a case by case basis.

- 84 a. Is it reasonable to assume at this time that a Non-Wires Alternative can be physically sited in the area?
- 85 b. Is it reasonable to assume at this time that there are no environmental concerns with Non-Wires Alternatives in the area?
- 86 c. Is it reasonable to assume at this time that local residents would accept a Non-Wires Alternative Solution in the area?
- 87 d. Is there no other capital project already approved in the same station?

88

² EPRI 3002019254 Analysis Assessment and Comparison

89

6. GENERAL FRAMEWORK

90

The following Chapter outlines the general NWA Framework, including which distributed energy resources (DER) are considered, how reliability is considered, and how forecasts and financial planning horizons are applied.

92

A. CONSIDERED RESOURCES

93

The NWA Framework is designed to consider both in front of and behind the meter (FTM / BTM) DER technologies in the NWA Evaluation Process. BTM DERs are assumed to be 3rd party owned and operated through a utility program. Table 1 outlines the DER technologies which are considered in the NWA Framework as options for deferring capital investments.

96

Table 1: DER Technologies Considered as NWAs

NWA	Definition	Capabilities
Energy Efficiency (EE)	Reduction of load through energy efficiency initiatives in addition to naturally occurring and already planned for energy efficiency.	Reduces load profile overall but limited by availability that is defined by customer makeup
Demand Response (DR)	Temporary reduction of consumption through demand response programs <ul style="list-style-type: none"> ▪ Commercial DR ▪ Residential DR 	Reduces load for a fixed time with pre-conditioning and snap back effects
Photovoltaic (PV)	Solar PV installations <ul style="list-style-type: none"> ▪ Utility Scale Solar PV ▪ BTM Solar PV 	Non-dispatchable output that is dictated by solar irradiance profiles
Battery Energy Storage System (BESS)	Lithium Ion Battery Systems <ul style="list-style-type: none"> ▪ Utility Scale BESS (Infront of meter) ▪ BTM BESS 	System needs to provide enough capacity to recharge during cycles, can provide both active and reactive power
Combined Heat and Power (CHP)	Customer Program CHP solutions incentivized by the Utility Energy Efficiency Program	Modeled to run continuously and generates revenue from electricity and heat. Dispatch capability assumed through Enbala DR Platform
Conservation Voltage Reduction (CVR)	Voltage modification scheme that reduces system voltage to lower system load	Very limited impact which is highly dependent of the feeder makeup and types of loads, typically below 3%
Fuel Cell (FC)	Customer Program FC solutions incentivized by the Utility Energy Efficiency Program	Modeled to run continuously and generates revenue from electricity and heat. Dispatch capability assumed through Enbala DR Platform
Emergency Generation (EG)	Contracted generators (Diesel, Gas, etc.) that can be called upon by the utility	On-call resources with high reliability and flexibility; not renewable, could be noisy and have high emissions; typically, expensive to maintain.

97

98 **B. FORECASTING AND PLANNING HORIZONS**

99 To allow a technical and economic comparison on a level playing field, solutions are compared not simply with their initial
100 capital need, but over longer time horizons to ensure that they

- 101 a. Can meet future capacity needs in a reliable manner
- 102 b. Can maintain economic feasibility over longer time spans

103 As a result, the NWA Framework considers two-time frames, the System Forecast and the Financial Planning Horizon.

104 **SYSTEM FORECAST HORIZON**

105 The System Forecast Horizon describes the timeline over which the EDC can forecast load and generation growth on their
106 system. The NWA Framework assumes a 10-year System Forecast Horizon. Within that 10-year horizon the utility can provide
107 a load growth and DER adoption forecast which allows determination of the expected system peaks. Capacity deficits can only
108 be determined within that 10-year forecasting horizon. As a result, traditional and DER investments can only be made within
109 those ten years. The NWA Framework does not concern itself with the forecasting methodologies but takes a completed fore-
110 cast as an input for each of the ten (10) years.

111 The System Forecast Horizon is set at the Base Year + 10 years. The Base Year describes the last year with a complete annual
112 timeseries data set using 15-min interval data.

113 **FINANCIAL PLANNING HORIZON**

114 The Financial Planning Horizon defines the time horizon over which the NWA solution is assumed to be active. Within the
115 Financial Planning Horizon, the tool will automatically track replacement of components, such as battery cells, as needed and
116 O&M costs. The Financial Planning Horizon hereby needs to be larger than

117 $\text{FirstConstraintYear} + \text{DeferralYears} - \text{BaseYear}$ 06.B.01

118 This is to ensure that the cost of the NWA is considered for the entire time span over which it needs to defer the traditional
119 solution.

120 The NWA Framework suggests following approach to setting up the Financial Planning Horizon: **Shortest Expected Lifespan**.
121 Using the shortest asset lifespan in addition to the year of construction yields the total financial planning horizon. E.g. with the
122 inclusion of a battery storage system, the shortest expected lifespan is 12 years for the battery cells. The financial planning
123 horizon can now be 12 to 22 years from the base year, depending on when the battery asset is constructed. E.g., the Battery
124 Solution is to be constructed in year 8 of the System Forecast, as a result the Financial Planning Horizon is $8 + 12 = 20$ years
125 from the Base Year.

126 **Note:** The financial planning horizon needs to reach further at all times than the date to which the traditional solution is de-
127 ferred.

128 **TERMINAL COST**

129 With a varying Financial Planning Horizon all assets are considered with their entire lifetime revenue requirements impact. For
130 this purpose, the Framework requires revenue requirements up to the financial planning horizon, which includes 1) new in-
131 vestments such as asset replacements as well as O&M, and 2) the terminal cost after the planning horizon which no longer
132 includes O&M or new investments and simply sums the remaining cumulative net present value revenue requirements.

133 DEFERRING CAPACITY NEED

134 a. **Deferral within the System Forecast Horizon:** If an NWA solution defers the capacity only so much that the need arises
 135 again within the 10-year System Forecast Horizon, a simple value of deferral is calculated using the applicable inflation
 136 rate, technology cost reduction, and discount rate to create a change in NPV revenue requirements. Therefore, the NPV of
 137 the cost of the NWA solution plus the NPV of the cost of the deferred traditional solution must be less than the NPV of the
 138 cost of the traditional solution alone. This is shown in the equation below:

139
$$NWA(t)_{NPV} + Traditional(t + n)_{NPV} \leq Traditional(t)_{NPV}$$
 06.B.02

140 where the traditional solution is depreciated over 40 years.

141
 142 b. **Deferral past the System Forecast Horizon:** With a ten (10) year forecasting horizon, it may happen that an NWA solution
 143 is capable of deferring the capacity need past the horizon. In this case, the capacity need is deferred to the first year after
 144 the forecast. With a 10-year forecast, the maximum possible deferral is ten (10) years. This limits the value an NWA can
 145 produce by deferring capital investments by no more than 10 years, as the assumption is that in year eleven (11) the capital
 146 project would be needed.

- 147 • **Situational:** Based on the forecast trends and the chosen NWA solution, a decision can be made to declare the
 148 deferral to be ≥ 10 years. E.g. if forecasts show a decline

149 Figure 1 illustrates an example of the application of different timelines in the financial planning model. Hereby, a capacity need
 150 at year five (5) is deferred by five (5) years.

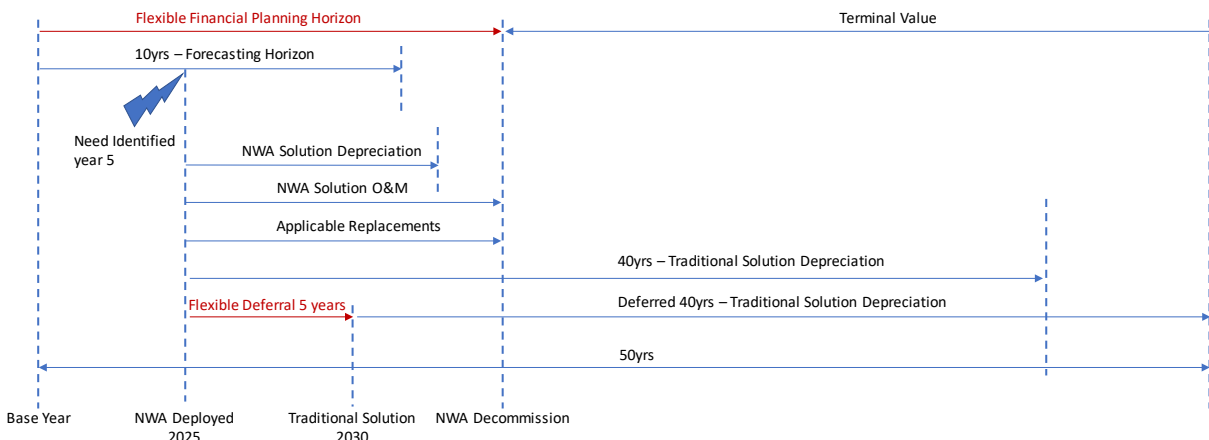

151

152 **Figure 1: Financial Timelines in NWA Framework**

153 **C. NWA DISPATCH OPTIONS**

154 For EDCs to consider DERs as NWAs they need to provide the same level of availability as traditional solutions. While, in most
 155 cases, the EDC will be able to forecast high load conditions and the associated dispatch need, unforeseen conditions need to
 156 be taken into consideration as well. Such conditions can include storm impacts or other events of natural or human cause that
 157 interrupt or disable capacity carrying parts of the system. In such an event, much like the traditional solution counterpart, load
 158 might need to be transferred to the NWA on very short notice.

159 In conclusion, there are two dispatch options

- 160 a. **Planned Dispatch:** up to 48-hours ahead, the EDC can determine peak load events and provide dispatch schedules for the
161 NWA to mitigate such situations. This time frame allows the NWA to get “ready” for the dispatch if it is in non-ideal condi-
162 tions.
- 163 b. **Unplanned Dispatch:** the EDC calls upon an NWA within seconds of the actual dispatch due to an unforeseen event of
164 natural or human origin. The NWA does not have time to get “ready” for its dispatch but still needs to provide the full
165 service.

166 **Note:** Dispatch option b. is the more limiting for NWA technologies but cannot be excluded from the evaluation criteria, as
167 without it, the EDC needs to provide a contingency for the unplanned dispatch, which would likely be the traditional solution
168 upgrade that the NWA was aiming at deferring in the first place. As a result, several market participation options will not be
169 considered by the Framework specifically because they do not meet this asset readiness standard.

170

171

7. RELIABILITY MODEL

172
173
174

In order to assume availability of DERs that are used as an NWA, the company needs to ensure sufficient reserve margin, especially for assets that are controlled through utility owned programs. With NWA assets being part of the electric distribution grid’s supply capability, the same N-1 approaches apply as they would to transformers and other hardware.

175

This section describes the NWA Framework for reliability rules around DERs used for NWA purposes.

176

A. EXEMPTIONS FROM THE N-1 RELIABILITY DESIGN STANDARD

177
178
179
180
181
182

- a. **Energy Efficiency** programs replace existing hardware with newer, more efficient hardware. Once replaced, the new hardware permanently consumes less energy than its predecessor. As a result, Energy Efficiency measures can be exempted from an N-1 design criterion.
- b. **Conservation Voltage Reduction** includes the installation of new voltage regulating equipment at the station and along feeder lines. This equipment is not typically designed to N-1 standards, and for the purpose of the NWA Framework, CVR will therefore not be part of any N-1 design criterion.

183

B. RELIABILITY ASSUMPTIONS FOR CUSTOMER PROGRAMS

184
185
186

For residential customer sited DR, Battery Storage, and Solar assets which are controlled through customer programs an assumption on participation is made. The following equations are utilized to calculate the minimal customer behavior adjusted reliable capacity where the number of assets under contract is (n)

187

a. Residential Solar

188

$$P_{PVReliable_BTM} = (\sum P_{PVInstalled_BTM}) * \epsilon_{capPV} \left(1 - \frac{1}{n}\right) \quad 7.B.01$$

189

b. Residential Demand Response

190

$$P_{DRReliable} = (\sum P_{DRInstalled_BTM}) * \epsilon_{capDR} \left(1 - \frac{1}{n}\right) \quad 7.B.02$$

191

c. BTM Battery Storage

192

$$P_{BESReliable} = (\sum P_{BESInstalled_BTM}) * \epsilon_{capBES} \left(1 - \frac{1}{n}\right) \quad 7.B.03$$

193
194

d. **Commercial Demand Response** is treated slightly differently and functions similar to a normal N-1 approach where the largest asset is removed from the overall observation.

195

$$P_{DRComFirm} = (\sum P_{DRComReliable}) - \max(P_{DRComReliable}) \quad 7.B.04$$

196
197
198

ϵ_{cap} represents the saturation limit of distributed DR and PV. For example, if $\epsilon_{cap} = 0.8$ then no more than 80% of installed assets will ever be accounted for. The following values are used based on historic observations by the Eversource Energy Efficiency Group.

199

Table 2 shows the respective saturation factor for reliability calculations with

200 $\epsilon = \lim_{n \rightarrow \infty} \frac{P_{\text{Available}}}{P_{\text{Installed}}}$ 7.B.05

201 **Table 2: Saturated Reliability Factor for Utility Programs**

ϵ_{capPV}	ϵ_{capDR}	ϵ_{capBES}
0.95	0.80	0.80

202 **C. RELIABILITY ASSUMPTIONS FOR GRID SCALE BATTERIES**

203 Utility owned and operated grid-scale batteries are considered to be in the same N-1 reliability group as the station’s trans-
 204 formers. The resulting capacity which will be considered for grid scale-batteries is therefore calculated as follows

205
$$P_{\text{BatFirm}} = \begin{cases} (\sum P_{\text{Bat}}); & \max(P_{\text{Bat}}) \leq \max(P_{\text{Transformer}}) \\ (\sum P_{\text{Bat}}) - \max(P_{\text{Bat}}); & \max(P_{\text{Bat}}) > \max(P_{\text{Transformer}}) \end{cases}$$
 7.C.01

206 **Note:** It is therefore advisable that no single BESS exceeds the size of the largest station transformer as it would be entirely
 207 removed for the firm capacity calculation.

208 **D. RELIABILITY ASSUMPTIONS FOR DG**

209 All DG NWA solutions (Solar, Fuel Cell, CHP, Emergency Generators) are considered to be in a separate reliability group. The
 210 largest DG is excluded in the NWA Framework to calculate the Reliable DG Capacity $P_{\text{DGReliable}}$ analogous to the transformer +
 211 large scale BESS group.

212
$$P_{\text{DGReliable}} = (\sum P_{\text{DG}}) - \max(P_{\text{DG}})$$
 7.D.01

213 DER assets included in P_{DG} are

- 214 a. **Solar DG:** For solar DG, P_{DGsolar} represents the installed capacity adjusted for minimal certain
 215 weather adjusted output. See [Solar Generation](#) for details.
- 216 b. **Fuel Cells:** P_{DGFC} represents the nameplate installed capacity
- 217 c. **CHP:** P_{DGCHP} represents the nameplate installed capacity
- 218 d. **Emergency Generators:** P_{DGEg} represents the nameplate installed capacity

219

220 8. DISPATCH MODEL

221 In order to determine their ability to solve technical issues, the dispatch, especially of flexible resources such as BESS, needs to
222 be accurately modeled. The NWA Framework makes assumptions on DER dispatch modes and capabilities as outlined in the
223 following Chapter

224 A. PRIORITIZATION OF DER DISPATCH

225 The NWA Framework assumes that in a multi-solution NWA portfolio, the dispatch priorities are as follows:

- 226 a. **Permanently Altering Assets:** These technologies permanently alter the load of the system and are therefore always avail-
227 able and do not require an active dispatch to produce their benefit. The tool will use their contribution first to determine
228 if any remaining dispatch is required.
- 229 • Energy Efficiency
- 230 b. **Continuously Running Assets:** Assets that are assumed to be continuously running are considered next. Given the nature
231 of the resources, curtailment of their output would not make fiscal sense. Their contribution is set to nominal throughout
232 the day which is observed. Any remaining capacity need is handled by dispatchable assets.
- 233 • Solar: Has no variable cost and generates revenue when running
 - 234 • CHP: Installed through program funding with an assumed dispatch capability through DR system
 - 235 • Fuel Cell: Installed through program funding with an assumed dispatch capability through DR system
- 236 c. **Dispatchable Assets:** Dispatchable assets can change their dispatch characteristics to the extent that their technical limi-
237 tations allow them to.
- 238 • **CVR:** Dispatch of tap changers at transformers, capacitors, and in-line voltage regulators with no marginal cost of
239 dispatch
 - 240 • **Utility Program Dispatch:** Any utility program, such as DR management, fall under this category
 - 241 i. DR (Commercial and Residential DR), limited to one dispatch a day
 - 242 • **Utility Owned Asset Optimization and Battery Programs:** Remaining capacity need can be managed by storage.
243 Storage is prioritized before emergency generation assets from an ecological standpoint. This includes the use of
244 Battery Storage DR Programs.
 - 245 i. Utility Scale Battery Storage
 - 246 ii. BTM Storage Control Programs
 - 247 • **Contracted Emergency Assets:** As a last resort emergency generation asset can be dispatched to fill any remaining
248 capacity gap. Their environmental impacts and associated costs make them the least desirable solution.
 - 249 i. Emergency Generator

250 B. SOLAR GENERATION

251 For consideration of solar distributed generation as an NWA the technology's technical capabilities are defined as follows by
252 the NWA Framework (these apply to both utility scale and BTM installations, their different considerations by the NWA Frame-
253 work on reliability can be reviewed in 7.D. Reliability Assumptions for DG; any values considered in this section are the result
254 of those reliability assumptions).

- 255 a. **Time Variant Output:** Solar PV installations can only generate power during the hours when the sun is shining (typically
256 daytime hours in the U.S.), therefore, any capacity deficits which occur outside those hours cannot be addressed through

257 solar. Solar generation potential is defined through clear sky irradiance profiles³. These clear sky irradiance profiles repre-
 258 sent ideal weather conditions and change with the day of the year. The following simplified equation is used to determine
 259 the P_{DC} panel output over time.

260
$$P_{DC}(t) = \frac{I_{ClearSky}(t)}{1000 \frac{W}{m^2}} * P_{DCRated} \tag{8.B.01}$$

261 The Framework does not consider losses or orientation of the solar array and rather assumes ideal conditions for both.

262

263 b. **Minimal Weather Adjusted Output (MWAC):** In order to account for weather conditions and the chance of non-ideal
 264 conditions for solar generation, a Minimal Weather Adjusted Relative Irradiance $\epsilon_{IrrMWAC}$ has been evaluated through data
 265 analytics on historic irradiance data sets. A Minimal Weather Adjusted Relative Irradiance shall be used for all three seasons
 266 using the 10th percentile on the event distribution.

- 267 • **Summer:** Jun, Jul, Aug 16.6%
- 268 • **Transition:** Mar, Apr, May, Sept, Oct, Nov 18.1%
- 269 • **Winter:** Dec, Jan, Feb 24.1%

270

271 The resulting Minimal Weather Adjusted Clear Sky Irradiance Profile can therefore be determined by

272
$$I_{ClearSkyMWAC}(t) = I_{ClearSky}(t) * \epsilon_{IrrMWAC} \tag{8.B.02}$$

273

274 Resulting in a Minimal Weather Adjusted DC Capacity of

275
$$P_{DCMWAC}(t) = \frac{I_{ClearSkyMWAC}(t)}{1000 \frac{W}{m^2}} * P_{DCRated} \tag{8.B.03}$$

276

277 No conversion losses are modeled for solar distributed generation, and the $P_{DCMWAC}(t)$ results can be directly converted
 278 to the resulting $P_{ACMWAC}(t)$ values as follows. If $P_{DCMWAC} > P_{ACRated}$, P_{ACMWAC} is capped at $P_{ACRated}$.

279
$$P_{ACMWAC}(t) = \max_{P_{ACRated}} P_{DCMWAC}(t) \tag{8.B.04}$$

280

281 c. **Degradation:** The NWA Framework does not account for panel degradation over time but assumes a replacement of panels
 282 every 20 years.

283 **Note:** The NWA Framework defaults the P_{DC} to P_{AC} ratio as 1.2.⁴

284

285 Figure 2 shows an application of solar distributed generation to reduce a capacity deficit. Using the evaluation framework for
 286 solar distributed generation, this capacity curve was calculated as follows:

287

- 288 a. The plan calls for four (4) systems at $P_{ACRated} = 2$ MW each; no other DERs are considered
- 289 b. The systems are defined as having an $\frac{P_{DCRated}}{P_{ACRated}} = 1.5$ ratio
- 290 c. The reliability framework accounts for only three (3) of the four (4) systems at 2 MW each, assuming the loss of the largest
 291 asset
- 292 d. The clear sky irradiance profile is converted to the Minimal Weather Adjusted clear sky irradiance profile and applied to
 293 P_{DCMWAC} to calculate $P_{DCMWAC}(t)$ using summer profiles

³ The NWA Framework bases its Clear Sky Irradiance data off Clean Power Research’s SolarAnywhere® Datasets

⁴ Data based on historic trend analysis of large-scale solar system installations in CT

- 294 e. In no instance does $P_{DCMWAC}(t)$ exceed $P_{ACRated}$, therefore there is no capping of the expected output
 295 f. The resulting Minimal Weather Adjusted capacity curve peaks at 3.15 MW, or 39.3% of $P_{ACRated}$, or 26.3% of $P_{DCRated}$
 296 g. Due to the time of peak, very little contribution is made by solar to the capacity deficit shown in the example below.
 297

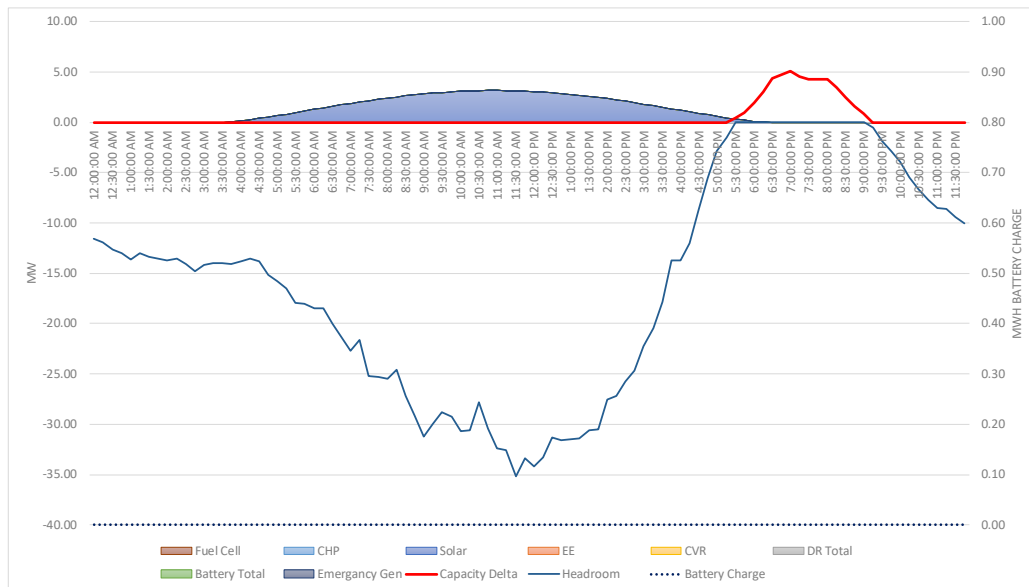

298
 299 **Figure 2: Application of Minimal Weather Adjusted Solar Generation Capacity to a Capacity Deficit**

300 **C. ENERGY EFFICIENCY**

301 Energy Efficiency is modeled as a permanent dispatch from the year of installation. This means, that the Energy Efficiency
 302 impacts will be modeled as continuously on, regardless of whether there is a capacity deficit or not. Energy Efficiency is modeled
 303 for four (4) distinct applications as well as a generic application, each with different profiles. Energy Efficiency is calculated as
 304 follows over the course of a day, with $\epsilon_{Type}(t)$ the Energy Efficiency specific profile type. The Energy Efficiency profiles listed
 305 below are based on internal experience of the EE-Team.

306
$$P_{EE} = \sum_{Type} (P_{EEType} * \epsilon_{Type}(t))$$
 8.C.01

- 307 a. **Lighting:** Lighting Energy Efficiency is assumed to mostly target commercial and industrial lighting, as a result, Energy Effi-
 308 ciency savings will manifest themselves during working hours. Commercial and industrial lighting-based Energy Efficiency
 309 will take effect starting at 7am and stop at after 6pm. No seasonal dependency is assumed for Lighting Energy Efficiency
 310 measures.

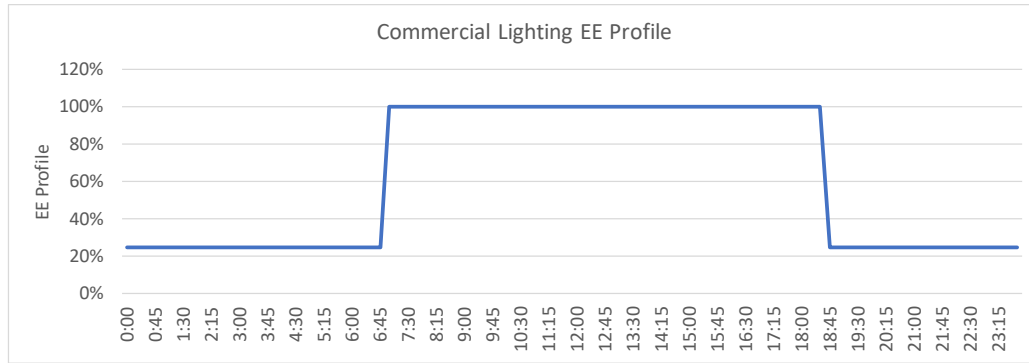

311

312 **Figure 3: Daily Lighting EE Profile**

- 313 b. **Residential Lighting:** Residential Lighting is assumed to provide the most impact in the evening hours after 7pm.
 314 c. **HVAC Commercial:** Commercial HVAC is assumed to mostly be active during the day, with minimal activity at night. It is
 315 also dependent on the time of year. The underlying assumption is that HVAC load will be the highest during summer
 316 months, the lowest during spring and fall, with a minor peak during winter.
 317 To determine the day of year dependency of potential commercial HVAC savings, the following equation applied in the
 318 NWA Framework:

319
$$\epsilon_{HVACCommYearly}(t) = 1 + \cos\left(\frac{15 \text{ min Interval of the Year}}{\text{Total number of 15 min Intervals per Year}} * 4\pi\right) + \frac{1}{3} \sin\left(\frac{15 \text{ min Interval of the Year}}{\text{Total number of 15 min Intervals per Year}} * \pi\right)$$

 320 8.C.02

321 which results in the annual curve for HVAC below.

322

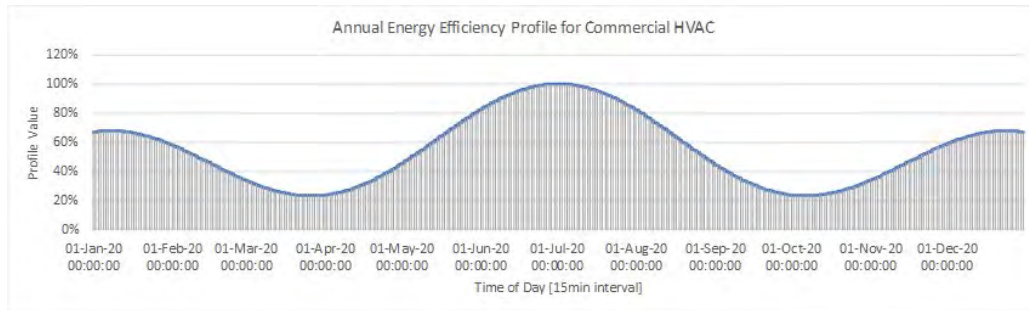

323

324 **Figure 4: Annual Commercial HVAC EE Profile**

325 For daily profile of commercial HVAC Energy Efficiency,

326
$$\epsilon_{HVACCommDaily}(t) = \frac{1}{2} \left(1 + \sin\left(\pi * \frac{15 \text{ min Interval of the Day}-10}{\text{Total number of 15 min Intervals per Day}}\right) \right) * \epsilon_{HVACCommYearly}(t)$$

 327 8.C.03

328

329

330

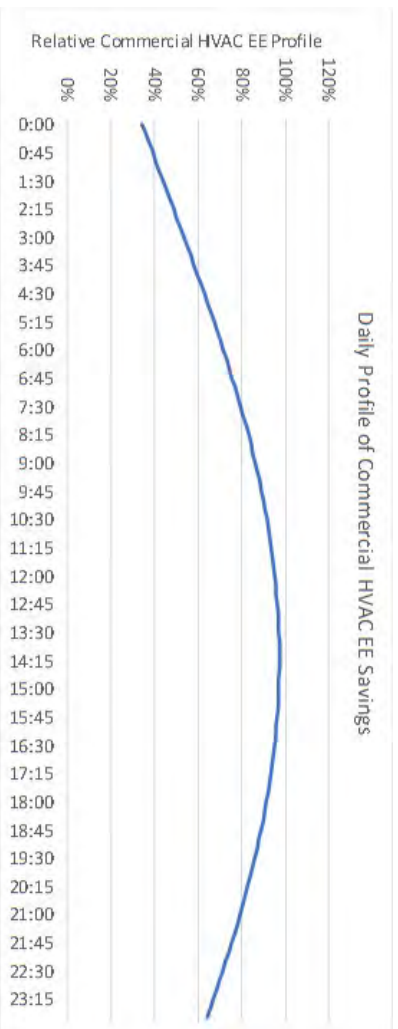

331

Figure 5: Daily Profile for Commercial HVAC EE

332

d. **HVAC Residential:** The HVAC residential follows the same yearly distribution as the HVAC commercial application, see above Equation 8.C.02.

333
334

$$E_{HVAC_{Res}}_{Yearly}(t) = E_{HVAC_{Com}}_{Yearly}(t)$$

335
336

8.C.04

However, given that residential HVAC applications typically have a higher yield in the evening hours and at night as opposed to the commercial HVAC which typically operates during the day, the profile has been adjusted. For the daily profile of residential HVAC, the following profile function is applied.

$$E_{HVAC_{Res}}_{Daily}(t) = \left(0.7 + \frac{3}{10} \sin \left(2\pi * \frac{15 \text{ min Interval of the Day} + 30}{\text{total number of 15 min Intervals per Day}} \right) \right) * E_{HVAC_{Res}}_{Yearly}(t)$$

340
341

8.C.05

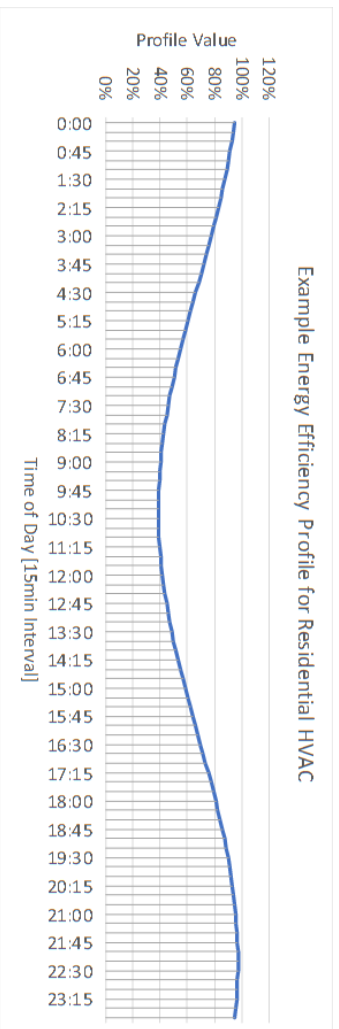

Figure 6: HVAC Residential HVAC EE Profile

342

D. DEMAND RESPONSE

344

Demand Response (DR) is classified into two types, commercial and residential DR. Both types of DR will dispatch automatically if there is a modeled capacity delta. The dispatch is modeled as a binary function, activating all of the resources or none.

345
346

DR contracts provide for a 3-hour dispatch minimum window. Longer dispatch windows can be simulated, but an adjustment to the overall DR volume needs to be made, as the EDC would then stagger the DR resources to achieve such an effect.

347
348

SNAP BACK AND PRE-CONDITIONING

349

350 Both DR resource types are modeled with pre-conditioning (e.g. through precooling before an event) and a snap back (e.g.
 351 through re-cooling after an event).

- 352 a. **Pre-Cooling** lasts 30 min and is defaulted to 60% of the total DR impact and is user adjustable depending on local conditions
- 353 b. **Snap Back** lasts for 2 hours after the event and is defaulted to 60% of the total DR impact and is user adjustable depending
- 354 on local conditions

355 Figure 7 shows a modeled DR event with 2 MW of commercial, and 0.5 MW of residential DR capacity. Clearly visible, the pre-
 356 conditioning and snap back, before and after the event respectively.

357

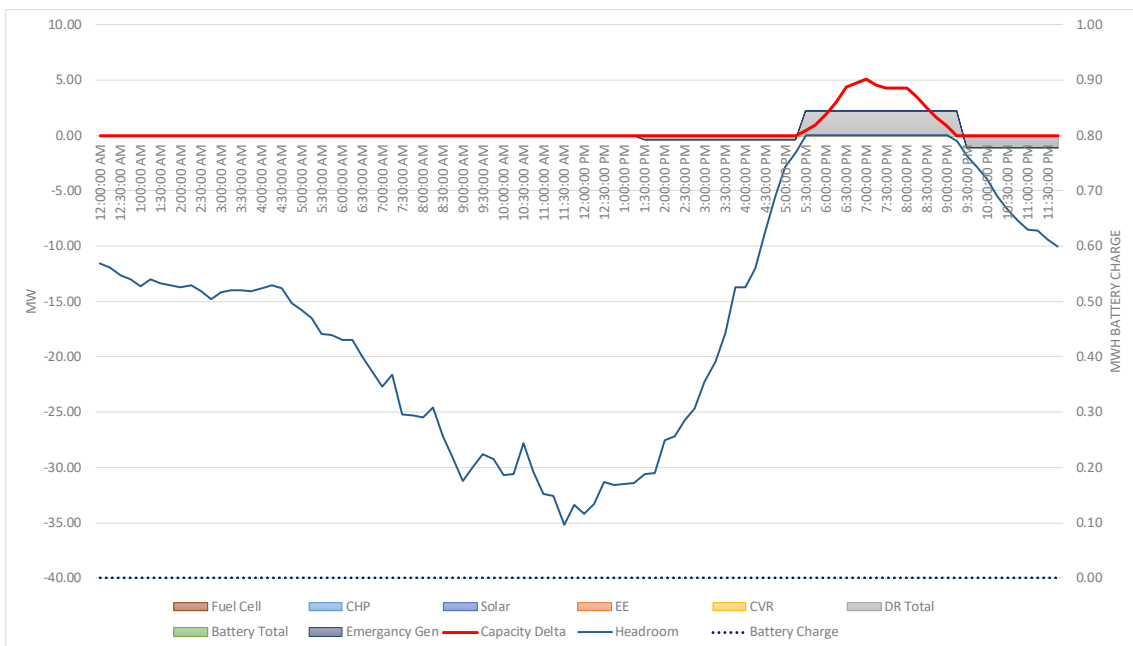

358

359 **Figure 7: Example DR Event with Pre-Conditioning and Snap Back**

360 **AVAILABILITY OF DR RESOURCES**

361 DR resources, much like EE, are only available if the underlying load is actually being used. For EE, the Framework models this
 362 approach with a seasonal and intra-day dependency. For commercial and residential DR, the NWA Framework provides a similar
 363 approach. As both forms of DR (excluding BTM storage) are typically based on HVAC applications, their highest impact will be
 364 achieved during peak summer month during afternoon hours. Figure 8 highlights the peak availability of DR resources through-
 365 out the year assumed in the NWA Framework.

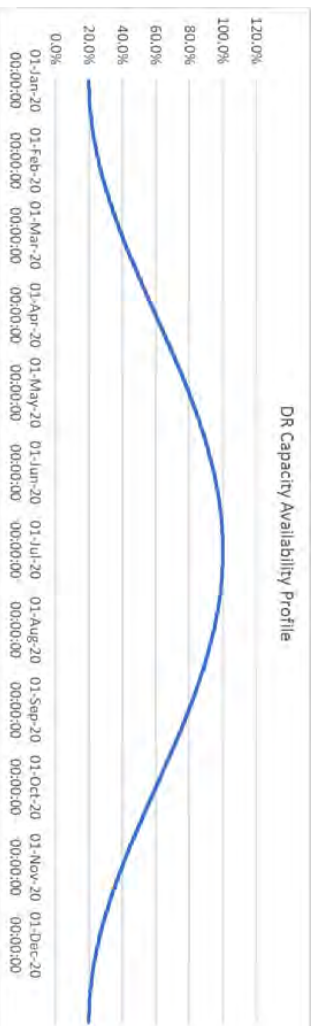

366
367 **Figure 8: Annual DR Capacity Availability Profile**

368 For each individual day, the Annual DR Capacity Availability Profile provides the peak DR response that can be expected based
369 on the contracted volume. All contracted volume is given at 100% Annual DR Capacity. For each individual day, the value is
370 then scaled to a daily profile to match actual resource usage. Figure 8 shows the Framework's availability profile for commercial
371 and residential DR resources.

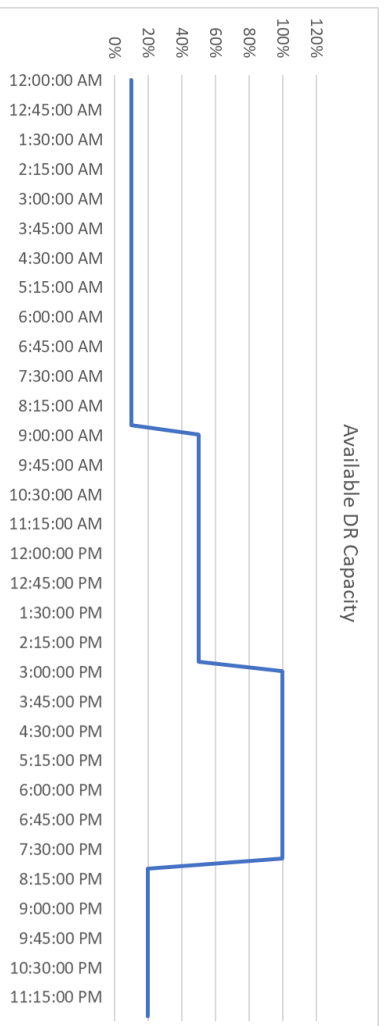

372
373 **Figure 9: Available DR Capacity Profile**

374

375 E. CONSERVATION VOLTAGE REDUCTION

376 Conservation Voltage Reduction (CVR) is given as a percentage of feeder load and as such varies over time. During a low load
377 situation CVR will consequently reduce the load less in absolute numbers, than it does during a high load situation. The default
378 assumed maximum reduction value is 1.8%, which is lower than the 2.34⁵ reported by EPRI (only report with more constant
379 impedance loads), but the number can be changed depending on the feeder topology and load constellation. The 1.8% repre-
380 sents values evaluated by the Company on its own circuits and requires a high-level evaluation for each region to ensure that
381 such targets can be reached.

382 F. BATTERY STORAGE

383 For the purpose of technical evaluation all available battery resources are dispatched in the same manner. Hereby no distinction
384 is made between grid scale battery systems and BTM solutions. Further, only battery resources that are under direct control of
385 the utility are considered as NWA options, both utility scale and behind the meter.

386 Battery dispatch is constrained by:

- 387 a. **Maximum Charging/Discharging Power:** It is assumed that a battery has a symmetric dispatch and can achieve its full rated
388 power both when charging or discharging and is limited only by the inverter capabilities. No reactive power dispatch will
389 be taken into consideration.
- 390 b. **Available Headroom:** The battery will not (dis)charge in a fashion that introduces new capacity violations, therefore, re-
391 charge limitations are in place and a battery might find itself in a situation where it cannot recharge fast enough to support
392 a new capacity constraint. It will take into consideration any additional capacity from Permanently Altering and Continu-
393 ously Running Assets (See Section 8.A.)
- 394 c. **Capacity Deficit:** The battery will not (dis)charge more than is required to eliminate a capacity deficit. This means, only the
395 absolute required minimum usage of the battery is assumed, which would equal ideal conditions.
- 396 d. **State of Charge:** The battery cannot charge, or discharge more than its state of charge allows. Batteries are assumed to be
397 able to charge between 0% and 100% of their nameplate capacity. All the batteries are given an initial state of charge for
398 the peak day simulation. That initial state of charge can be freely chosen⁶ by the user. The dispatch simulation requires the
399 batteries to return to the same SOC at the end of the simulated day, to ensure same initial condition should the following
400 day also require battery dispatch for NWA purpose. The default setting here is 50%, stating that the battery starts, and
401 ends, each day at 50% state of charge.
- 402 a. **IMPORTANT:** If the battery is unable to attain at least the same SOC at the end of the peak day that it started the
403 day with, it is at high risk of not being able to perform two consecutive event days. This means that the station
404 does not have enough headroom to allow adequate recharging of the BESS.
- 405 e. **Degradation:** No degradation of storage capacity is applied in the NWA Framework
- 406 f. **Round Trip Efficiency:** A round trip efficiency is defined in the NWA Framework, which is applied equally to the charging
407 and discharging cycles with

408
409 $\sqrt[2]{\%_{\text{roundtrip}}}$

8.F.01

410

⁵ <https://www.epri.com/research/products/1024482>

411 The charge and discharge efficiency are taken into consideration for SOC modeling, energy loss calculations, and when
412 determining the ideal system size.

413 If any capacity deficit cannot be met by the battery, either because it does not have sufficient power, or because it has run
414 empty, this will be highlighted.

415 G. FUEL CELL

416 Fuel Cell units are assumed to be must run assets and are modeled as continuously running. See Chapter 6.A and 9.K. The NWA
417 Framework assumes that, outside of reliability considerations, any downtime for Fuel Cells will be maintenance-related and
418 scheduled outside of possible event days.

419 H. COMBINED HEAT AND POWER

420 Combined Heat and Power (CHP) units are assumed to be must run assets and are modeled as continuously running. The NWA
421 Framework assumes that, outside of reliability considerations, any downtime for CHPs will be maintenance-related and sched-
422 uled outside of possible event days.

423 I. EMERGENCY GENERATION

424 Emergency Generation units are dispatched to compensate any capacity deficits. Their dispatched is modeled as binary, either
425 on or off. They are not modeled to require warm up or spool down times as the resolution of the NWA Framework is 15 min,
426 which provides adequate time for a generator to reach operational output. Aside from N-1 considerations, Emergency Gener-
427 ators are modeled at name plate rating.

428

429

9. COST MODEL

430 For the NWA Framework, the Cost Model describes how costs of all types of solutions, NWA and traditional are modeled. For
 431 all NWA solutions, the same cost model is applied (with the exception of CVR). Where an NWA solution does not have a cost
 432 factor, the values are considered null.

433

A. TRADITIONAL SOLUTION

434 Traditional Solution cost is provided in the NWA Framework in three categories

435 a. **CapEx:** Capital Expenses for traditional solutions are provided for a single year of expense; the NWA Framework assumes
 436 for simplicity reasons that all cost can be allocated to a single year. The Framework provides for entries in the following
 437 fields, which are all summed up to be included in the total CapEx of the project:

- 438 a. Labor and Equipment
- 439 b. Engineering
- 440 c. Material
- 441 d. PM Support / Permitting
- 442 e. Removal
- 443 f. Contingency
- 444 g. Escalation
- 445 h. Indirects
- 446 i. AFUDC

447 b. **OpEx:** Operational Expenses are provided starting the year of the project and represent any increase or decrease in OpEx
 448 due to the new solution. A decrease in OpEx due to a new traditional solution can also be included as a negative value. Any
 449 change in OpEx will be extrapolated forward over the full financial planning horizon.

450 c. **Real-Estate Cost:** Any property purchases required are recorded separately. An annual addition to the revenue require-
 451 ments is made through multiplication of the sum of all property purchases made to that point in time, multiplied by the
 452 WACC

453
 454
$$WACC * \sum_i^t \$_{PropertyPurchase}(t)$$
 9.A.01

455

B. NWA COST TYPES

456 The NWA Framework accounts for four (4) types of cost when it comes to DERs under consideration for NWA opportunities.

457 a. **CapEx Cost:** Capital Expenses (CapEx) are treated as expensed in a single year for any DER project. E.g., the installation of
 458 a battery system carries \$5.5 Million CapEx cost. Even if the project to build said battery system might, in reality take more
 459 than a year, the Framework assumes those costs occur in the year the solution is deployed.

- 460 ▪ CapEx costs are increased on a yearly basis using a general inflation rate
- 461 ▪ CapEx costs have a book depreciation over the asset's life span (12, 20, or 40 years)
- 462 ▪ CapEx costs have a tax depreciation over either 5, 7, or 20 years
- 463 ▪ CapEx costs for specific asset types have a technology cost reduction, such as solar panels

464
 465 CapEx Cost includes the following line items in the cost model for each type of NWA

- 466 ▪ **Equipment Cost:** Includes all NWA asset equipment, such as generators, panels, or inverters. Reappears for an
 467 asset replacement. Given in \$/MW. For accounting purposes (see Chapter 10.A. Accounts), these costs are split
 468 between the following positions where applicable
- 469 ○ **Distribution Hardware**
 - 470 ○ **Inverters**
 - 471 ○ **Generators/Motors/CHP/Fuel Cells**
 - 472 ○ **Battery Cells**
- 473 ▪ **Interconnection Equipment:** Includes all equipment required to interconnect the asset. Does not re-appear for
 474 an asset replacement. Given in \$/MW
- 475 ▪ **Replacement Cost:** For NWA solutions with a lower life span than financial planning horizon, a replacement of the
 476 Equipment cost is considered in addition to a labor factor. Given in \$/MW
- 477 ○ **Battery Cells** are replaced after 12 years
 - 478 ○ **Inverters** are replaced after 20 years
 - 479 ○ **Solar Panels** are replaced after 20 years
 - 480 ○ **Generators, CHP, and Fuel Cells** are replaced after 20 years
 - 481 ○ **All Other Hardware** is replaced after 40 years
- 482 ▪ **Engineering, Installation, and Commissioning:** All labor associated with the installation of the Equipment and the
 483 Interconnection. This includes labor, EPC overhead, and any interconnection costs with the utility. Given in \$/MW
- 484 ▪ **Overhead:** Project management and internal overhead for projects. Given in % of other CapEx cost where x rep-
 485 resents the respective CapEx cost components as (for battery systems, the includes the battery cell component
 486 cost)
- 487
$$\sum \left(P_{inst} * x \frac{\$}{MW} \right)$$
 9.B.01
- 488
- 489 b. **OpEx Cost:** Operational Expenses (OpEx) are treated as expenses reoccurring every year. Reoccurring cost, program or
 490 OpEx, are calculated on a yearly basis.
- 491 ▪ OpEx costs are increased on a yearly basis using a general inflation rate
 - 492 ▪ OpEx costs are treated as a direct passthrough to revenue requirements without additional earnings add on
- 493
- 494 OpEx Cost include the following line items in the cost model for each type of NWA
- 495 ▪ **Fixed O&M:** Includes all maintenance and minor replacement activities, in addition to any running cost that are
 496 not dependent on utilization.
 - 497 ▪ **Variable O&M:** Includes all fuel and other variable cost that is dependent on either the energy produced or the
 498 Full Load Hours of operation per year.
 - 499 ▪ **Full Load Hours:** For variable O&M this represents the assume ratio of $\frac{\text{Energy}}{\text{Year}} \div P_{inst}$
- 500 c. **Real-estate Cost:** Real-estate cost can come into consideration for traditional solutions, grid scale solar DG and storage
 501 systems. Investments into properties cannot be depreciated, but will be accounted for with WACC
- 502 ▪ Real-estate costs are increased with the yearly inflation rate
- 503
- 504 d. **Program Costs:** There are two types of Program Costs, reoccurring, such as costs created through Demand Response Pro-
 505 grams, and one-time program costs, such as for the deployment of energy efficiency measures
- 506 ▪ **One Time Program Cost:** Added to the OpEx costs the year they are incurred with an earnings multiplier
 - 507 ▪ **Reoccurring Program Cost:** Added to the OpEx cost every year they are incurred with an earning multiplier
 - 508 ▪ Program Costs are not increased on a yearly basis using a general inflation rate

509 **C. ANNUAL RATES OF CHANGE**

510 All values in the NWA Framework are provided in nominal values. To account for inflation, and the reduction in cost for certain
 511 technologies, the NWA Framework provisions for annual rates of change for the following

- 512 a. **Inflation Rate:** The inflation rate is defaulted to 2% and applies to all hardware, labor, real estate and O&M costs. Program
 513 costs are excluded from inflation
- 514 b. **Discount Rate:** The discount rate is given as a nominal discount rate and defaulted to -3.37% ⁷. The effective discount
 515 rate is calculated, depending on the year the expense happens as
 516 $(100\% + \epsilon_{\text{Discount Rate}} + \epsilon_{\text{Inflation Rate}})^{t-\text{Base Year}}$ 9.C.01
- 517 c. **Cost Rate PV Panels**⁸: The cost rate for PV Panels provides a projection of cost development of PV Panels instead of the
 518 inflation rate. PV Panels are not subject to the inflation rate but adhere to changes based on the Cost Rate for PV Panels.
 519 The NWA Framework defaults this value at -4.0%
- 520 d. **Cost Rate Battery Cells**⁹: The cost rate for Battery Cells provides a projection of cost development of Battery Cells instead
 521 of the inflation rate. Battery Cells are not subject to the inflation rate but adhere to changes based on the Cost Rate for
 522 Battery Cells. The NWA Framework defaults this value at -5.0%
- 523 e. **Cost Rate Inverters**¹⁰: The cost rate for Inverters provides a projection of cost development of Inverters instead of the
 524 inflation rate. Inverters are not subject to the inflation rate but adhere to changes based on the Cost Rate for Inverters.
 525 The NWA Framework defaults this value at 6% . This value applies to both Battery and Solar inverters. While the NREL
 526 report highlights a 2019 price increase of 20% for utility scale central inverters, that number will most likely not be sustain-
 527 able.

528 **Table 3: Application of Annual Change Rates Based on Cost Component**

Component	Inflation Rate	Discount Rate	Cost Rate Panels	Cost Rate Cells	Cost Rate Invert.
Real Estate	X	X			
Traditional	X	X			
Int. Hardware	X	X			
Any O&M	X	X			
Inverters	X	X			X
Battery Cells	X	X		X	
Solar Panels	X	X	X		
Gen., FCs, CHP	X	X			
Program Costs		X			
Electricity Cost	X	X			

⁷ <https://www.synapse-energy.com/sites/default/files/AESC-2018-17-080-Oct-ReRelease.pdf>

⁸ [NREL Q4 2019/Q1 2020 Solar Industry Update Page 39](#)

⁹ [NREL Cost Projections for Utility-Scale](#)

¹⁰ [NREL Q4 2019/Q1 2020 Solar Industry Update Page 64](#)

529 **Note:** All technology rates of change can be edited within the NWA Screening Tool to adjust to the ever-changing landscape.
 530 To provide a unified source of information, the NWA Framework uses NREL’s publications¹¹

531 **D. EARNING FACTORS UTILITY PROGRAMS**

532 For energy efficiency and demand management expenditures, the Company has the ability to earn a performance incentive
 533 averaging 5% of total program expenditures. Therefore, for purposes of modeling within the NWA solution the following rates
 534 are applied by state.

535 **Note:** Historic assumption is based on the level of generated benefits as a percentage of spend and depending on jurisdiction.

536 **Table 4: Program Performance Incentive**

State	MA	CT	NH
Assumed Performance Incentive	5.0%	5.0%	5.0%

537 These values are applied to:

- 538 a. Demand Response Programs, annually
- 539 a. Commercial
- 540 b. Residential
- 541 c. Battery Storage
- 542 b. Energy Efficiency Programs, once
- 543 c. Behind the Meter Solar Programs, annually

544 **E. LIFE CYCLE ASSUMPTIONS**

545 For the cost calculation, the NWA Framework makes assumptions on the useful life of an asset. This is achieved within the NWA
 546 Framework by clustering assets into three (3) expected useful life spans

547 **Table 5: Life Cycle Assumptions by Asset Type**

Asset Type	12-Year Assets	20-Year Assets	40-Year Assets
Traditional Solution			X
Interconnection Hardware			X
Inverters		X	
Battery Cells	X		
Solar Panels		X	
Generators, FCs, CHP		X	

548 The Life Cycle Assumptions will inform the calculation of the Revenue Requirements through the tax and book depreciation, as
 549 well as MACRS values.

¹¹ [NREL Annual Technology Baseline](#)

550 If, within the financial planning horizon selected, an asset reaches the end of its useful lifespan, it is assumed replaced by the
 551 NWA Framework with an addition investment happening in the last year of its expected lifespan. This process can, depending
 552 on the asset and the Financial Planning Horizon, happen more than once.

553 **F. SOLAR GENERATION**

554 For the NWA Framework, cost assumptions have been made for the cost of solar systems to supply default values.

555 **UTILITY SCALE SOLAR GENERATION**¹²¹³

556 **a. CapEx Cost**

557	▪	Equipment Cost:	
558		i. Panels	\$340,000/MW
559		ii. Solar Inverter (2 Quadrant)	\$62,000/MW
560	▪	Interconnection Equipment:	\$330,000/MW
561	▪	Replacement Cost: The default labor rate factor is at	$\epsilon_{\text{Replace}} = 20\%$
562	▪	Engineering, Installation, and Commissioning:	\$240,000/MW
563	▪	Overhead:	50%

564 **b. OpEx Cost**

565	▪	Fixed O&M: Fixed O&M cost is defaulted at	\$50,000/a
566	▪	Variable O&M:	\$0.00/MWh
567	▪	Full Load Hours:	1400h/a

568 **c. Real-Estate Cost:**

569 **d. Program Costs**

570	▪	One Time Program Cost	\$0/MW
571	▪	Reoccurring Program Cost	\$0/a * MW

572 With different sizes between inverters and panels, the cost model accounts for the Equipment Cost as follows

573
$$\frac{\$470,000}{\text{MW}} * P_{\text{InstDC}} + \frac{\$50,000}{\text{MW}} * P_{\text{InstAC}} \qquad \qquad \qquad 9.F.01$$

574 Where. For the NWA Framework, a default overlocking rate ϵ_{OC} is assumed for all solar generation, this value is defaulted to

575
$$\epsilon_{\text{OC}} = 1.2 \qquad \qquad \qquad 9.F.02$$

576

577

578

¹² <https://atb.nrel.gov/electricity/2019/index.html?t=su>

¹³ Solar Energy Industries Association, US Solar Market Insight, Full Report, Q4 2020

579 BEHIND THE METER SOLAR GENERATION:

580 The NWA Framework considers that behind the meter solar generation could provide an NWA to traditional utility investments
 581 in certain situations as part of a utility-managed program. However, current incentive structures available to behind the meter
 582 solar applications generally do not incentivize solar installations on a location-specific basis in order to ensure that installation
 583 would provide a benefit to the distribution system as an NWA.

584 a. **CapEx Cost**

- 585 • Equipment Cost: \$0.00/MW
- 586 • Interconnection Equipment: \$0.00/MW
- 587 • Replacement Cost: The default labor rate factor is at N/A
- 588 • Engineering, Installation, and Commissioning: \$0.00/MW
- 589 • Overhead: N/A

590 b. **OpEx Cost**

- 591 • Fixed O&M: Fixed O&M cost is defaulted at \$0.00/a * MW
- 592 • Variable O&M: \$0.00/MWh
- 593 • Full Load Hours: 1400h/a

594 c. **Real-Estate Cost:** \$0.00

595 d. **Program Costs**

- 596 • One Time Program Cost \$0/MW
- 597 • Reoccurring Program Cost \$35/a * MW

598 G. ENERGY EFFICIENCY

599 Energy Efficiency is conducted as a utility program with the assumption that all expenses happen in a single year, and that no
 600 continuous expenses are required.

601 a. **CapEx Cost**

- 602 • Equipment Cost: \$0.00/MW
- 603 • Interconnection Equipment: \$0.00/MW
- 604 • Replacement Cost: The default labor rate factor is at N/A
- 605 • Engineering, Installation, and Commissioning: \$0.00/MW
- 606 • Overhead: N/A

607 b. **OpEx Cost**

- 608 • Fixed O&M: Fixed O&M cost is defaulted at \$0.00/a * MW
- 609 • Variable O&M: \$0.00/MWh
- 610 • Full Load Hours: N/A

611 c. **Real-Estate Cost:** \$0.00

612 d. **Program Costs**

- 613 • One Time Program Cost \$50/10a * MWh
- 614 • Reoccurring Program Cost \$0/a * MW

615 The cost of energy efficiency programs is determined by through a \$/kWh saved metric ϵ_{EE} , with

616
$$\epsilon_{EE} = 50 \frac{\$}{\text{MWh} \cdot 10a}$$
 9.G.01

617 To calculate the cost of the total Energy Efficiency program, the savings over a ten (10) year time span are considered in the
 618 NWA Framework, resulting in an Energy Efficiency program cost of

619
$$EE_{\text{cost}} = \epsilon_{EE} * 10a * \int_0^{365} EE_{\text{kWh}} dd$$
 9.G.02

620 Where the savings are calculated over all days of the year using the Energy Efficiency Profiles.

621 All Energy Efficiency cost is incurred at the year on inception with no running cost. In addition, a Utility Earnings Factor, see
 622 Chapter 9.D. is applied to the cost.

623
$$EE_{\text{RevReq}} = EE_{\text{cost}} * (1 + \epsilon_{\text{Earning}})$$
 9.G.03

624 There is no inflation assumed for the cost of Energy Efficiency programs

625 H. DEMAND RESONSE

626 Demand Response Programs are, as part of the NWA Framework, modeled with a cost per kW. In reality, there is a performance
 627 factor applied, with some assets no performing at all events, or not to full specification. However, for the NWA Framework,
 628 some assumptions have been made to simplify the modeling

- 629 a. The assumption is that the assets are fully able to perform. As a result, the cost for DR programs can be reduced to an
 630 annual capacity payment without a performance component.
- 631 b. Unlike Energy Efficiency, DR costs are annual costs that continue to present over the course of the financial planning hori-
 632 zon.
- 633 c. Demand Response program costs are excluded from an inflation rate in the NWA Framework
- 634 d. Programs working with storage do not account for replacement of cells or batteries. That cost is covered by the owner and
 635 accounted for in the annual payments.

636 **COMMERICAL**

637 For commercial DR, the capacity payments are set at

638 **a. CapEx Cost**

- 639 • Equipment Cost: \$0.00/MW
- 640 • Interconnection Equipment: \$0.00/MW
- 641 • Replacement Cost: The default labor rate factor is at N/A
- 642 • Engineering, Installation, and Commissioning: \$0.00/MW
- 643 • Overhead: 0%

644 **b. OpEx Cost**

- 645 • Fixed O&M: Fixed O&M cost is defaulted at \$0.00/a * MW
- 646 • Variable O&M: \$0.00/MWh
- 647 • Full Load Hours: N/A

648	c. Real-Estate Cost:	\$0.00
649	d. Program Costs	
650	• One Time Program Cost	\$0/MW
651	• Reoccurring Program Cost	\$50,000/a * MW
652	Commercial DR contracts are limited to <u>eight (8) events a year</u> and can be expanded to include more events per year at an	
653	additional cost per kW. The event limit numbers are based on DR contracts as they are currently used by the company. To	
654	compute additional costs for larger DR contracts, the Framework defaults to an assumed surcharge of 50%.	
655	Total Events – Maximum Contract Events ≥ 0	9.H.01
656	$\epsilon_{DRCom} * \left(1 + 50\% * \frac{\text{Total Events} - \text{Maximum Contract Events}}{\text{Maximum Contract Events}} \right)$	
657	9.H.02	
658	Resulting in a cost of	
659	$50,000 \frac{\$}{kW} * \left(1 + 50\% * \frac{16-8}{8} \right) = 75,000 \frac{\$}{kW}$	9.H.03
660	The program is scaled to the year with the largest number of events in the forecasting horizon	
<hr/>		
661	RESIDENTIAL	
662	For residential DR, the capacity payments are set at	
663	a. CapEx Cost:	
664	• Equipment Cost:	\$0.00/MW
665	• Interconnection Equipment:	\$0.00/MW
666	• Replacement Cost: The default labor rate factor is at	N/A
667	• Engineering, Installation, and Commissioning:	\$0.00/MW
668	• Overhead:	0%
669	b. OpEx Cost:	
670	• Fixed O&M: Fixed O&M cost is defaulted at	\$0.00/a * MW
671	• Variable O&M:	\$0.00/MWh
672	• Full Load Hours:	N/A
673	c. Real-Estate Cost:	\$0.00
674	d. Program Costs:	
675	• One Time Program Cost	\$0/MW
676	• Reoccurring Program Cost	\$120,000/a * MW
677	Residential DR contracts are limited to <u>16 events a year</u> and can be expanded at a cost rate of 50% using the same methodology	
678	as the commercial DR contracts, see Equation 9.H.03	
679	The program is scaled to the year with the largest number of events in the forecasting horizon	

680 STORAGE

681 For storage DR, the capacity payments are set at

682 a. CapEx Cost:

- 683 • Equipment Cost: \$0.00/MW
- 684 • Interconnection Equipment: \$0.00/MW
- 685 • Replacement Cost: The default labor rate factor is at N/A
- 686 • Engineering, Installation, and Commissioning: \$0.00/MW
- 687 • Overhead: 0%

688 b. OpEx Cost:

- 689 • Fixed O&M: Fixed O&M cost is defaulted at \$0.00/a * MW
- 690 • Variable O&M: \$0.00/MWh
- 691 • Full Load Hours: N/A

692 c. Real-Estate Cost:

\$0.00

693 d. Program Costs:

- 694 • One Time Program Cost \$0/MW
- 695 • Reoccurring Program Cost \$250,000/a * MW

696 Battery DR contracts are limited to 60 events a year and can be expanded at a cost rate of 50% using the same methodology
 697 as the commercial DR contracts, see Equation 9.H.03

698 The program is scaled to the year with the largest number of events in the forecasting horizon

I. CONSERVATION VOLTAGE REDUCTION

700 CVR programs provide for a slightly altered cost structure. Based on the Company's experience, the cost to implement a CVR
 701 program at a Substation is highly variable based on present equipment, but is defaulted to

702 $\epsilon_{CVR_{Install}} = 2,500,000 \frac{\$}{Substation}$ 9.1.01

703 And takes an average of 12-man hours a week to operate, which results in an annual cost of

704 $\epsilon_{CVR_{O\&M}} = 78,000 \frac{\$}{Substation \cdot a}$ 9.1.02

J. BATTERY STORAGE

706 For battery storage solutions, the cost assumptions are based on NREL publications¹⁴.

707 a. CapEx Cost:

- 708 • Equipment Cost: The default value Battery Storage is at

¹⁴ <https://atb.nrel.gov/electricity/2019/index.html?t=st> based on 2-hour storage systems

709	i. Battery Cells	$\$209,000/\text{MWh}$
710	ii. Battery Inverter (4 Quadrant)	$\$70,000/\text{MW}$
711	▪ Interconnection Equipment:	$\$100,000/\text{MW}$
712	▪ Replacement Cost: The default labor rate factor is at	$\epsilon_{\text{Replace}} = 20\%$
713	▪ Engineering, Installation, and Commissioning:	$\$62,500/\text{MW}$
714	▪ Overhead:	50%
715	b. OpEx Cost:	
716	▪ Fixed O&M: Fixed O&M cost is defaulted at	$\$50,000/\text{a}$
717	▪ Full Load Cycles	N/A
718	c. Real-Estate Cost:	\$0.00
719	d. Program Costs:	
720	▪ One Time Program Cost	$\$/\text{MW}$
721	▪ Reoccurring Program Cost	$\$/\text{a} * \text{MWh}$
722	Note: Variable O&M for BESS is based on energy losses and cost of energy	

723 **K. FUEL CELL**

724 Fuel Cells are modeled as Commercial Fuel Cells with the following cost components in the NWA Framework. For the NWA
 725 Framework, they will be considered as part of the Energy Efficiency portfolio. The following outlines the default values assumed
 726 in the cost model.

727	a. CapEx Cost	
728	• Equipment Cost:	$\$0.00/\text{MW}$
729	• Interconnection Equipment:	$\$0.00/\text{MW}$
730	• Replacement Cost: The default labor rate factor is at	N/A
731	• Engineering, Installation, and Commissioning:	$\$0.00/\text{MW}$
732	• Overhead:	N/A
733	b. OpEx Cost	
734	• Fixed O&M: Fixed O&M cost is defaulted at	$\$0.00/\text{a} * \text{MW}$
735	• Variable O&M:	$\$0.00/\text{MWh}$
736	• Full Load Hours:	$6000\text{h}/\text{a}$
737	c. Real-Estate Cost:	\$0.00
738	d. Program Costs	
739	• One Time Program Cost	$\$700,000/\text{MW}$
740	• Reoccurring Program Cost	$\$/\text{a} * \text{MW}$

741 **L. COMBINED HEAT AND POWER**

742 CHPs are modeled as Commercial – Natural Gas Microturbines with the following cost components in the NWA Framework.
 743 They are deployed through incentive programs managed under the Energy Efficiency portfolio.

744	e. CapEx Cost	
745	• Equipment Cost:	\$0.00/MW
746	• Interconnection Equipment:	\$0.00/MW
747	• Replacement Cost: The default labor rate factor is at	N/A
748	• Engineering, Installation, and Commissioning:	\$0.00/MW
749	• Overhead:	N/A
750	f. OpEx Cost	
751	• Fixed O&M: Fixed O&M cost is defaulted at	\$0.00/a * MW
752	• Variable O&M:	\$0.00/MWh
753	• Full Load Hours:	6000h/a
754	g. Real-Estate Cost:	\$0.00
755	h. Program Costs	
756	• One Time Program Cost	\$1 000 000/MW
757	• Reoccurring Program Cost	\$0/a * MW

758 M. EMERGENCY GENERATION

759 Emergency Generation typically represents 3rd party owned and operated Diesel or Natural Gas Generators which an EDC se-
 760 cures under contractual obligation. These contracts include annual capacity payments as well as variable payments depending
 761 on the rate of utilization.

762	a. CapEx Cost:	
763	▪ Equipment Cost: The default value for Fuel Cells is at	\$0/MW
764	▪ Interconnection Equipment:	\$0/MW
765	▪ Replacement Cost: The default labor rate factor is at	N/A
766	▪ Engineering, Installation, and Commissioning:	\$0/MW
767	▪ Overhead:	N/A
768	b. OpEx Cost:	
769	▪ Fixed O&M: Fixed O&M cost is defaulted at	\$270,000/a * MW
770	▪ Variable O&M:	\$400/MWh
771	▪ Full Load Hours	N/A
772	c. Real-Estate Cost:	\$0.00
773	d. Program Costs:	
774	▪ One Time Program Cost	\$0/MW
775	▪ Reoccurring Program Cost	\$0/a * MWh

776

777

10. REVENUE REQUIREMENTS

778 The NWA framework includes representative revenue requirement calculations in order to compare the potential ultimate cost
 779 to customers of NWA and traditional solutions. Further detailed financial analysis would be conducted prior to the Company
 780 implementing any solution and amounts sought for recovery by the Company would also be based upon more detailed revenue
 781 requirement calculations.

782

A. GENERAL ASSUMPTIONS

783 For the NWA Framework, a simplified approach was chosen to evaluate the revenue requirements stemming from certain
 784 investments.

785

ACCOUNTS

786 The following accounts and Modified Accelerated Cost Recovery System (MACRS) depreciations are considered:

- | | | |
|-----|--|----------|
| 787 | a. 345 Inverters | 5 Years |
| 788 | b. 344 Solar Panels/Generators | 5 Years |
| 789 | c. 362 Distribution Station Equipment | 20 Years |
| 790 | d. 363 Storage Battery Equipment | 7 Years |

791 For the book depreciation, the following equipment lifespans are considered

- | | | |
|-----|---|----------|
| 792 | a. Battery Cells | 12 Years |
| 793 | b. Solar Panels, Inverters, Generators, Fuel Cells, CHP | 20 Years |
| 794 | c. All traditional hardware | 40 Years |

795 The resulting combinations for assets are

- | | | |
|-----|-----------------|--|
| 796 | a. 7/12 | Battery Cells |
| 797 | b. 5/20 | Solar Panels, Inverters, Generators, Fuel Cells, CHP |
| 798 | c. 20/40 | All traditional hardware |

799

DEPRECIATION ACCRUAL RATE

800 The Framework provisions the accrual rate as

801	$\frac{1}{\text{Asset Useful Life (years)}}$	10.A.01
-----	--	---------

802

PRE-TAX WACC

803 The Pre-Tax Weighted Average Cost of Capital (WACC) are calculated as follows

- | | | |
|-----|--|---------|
| 804 | a. Using a Federal Tax Rate of 21% and a state rate per selected state the Effective State Rate is calculated as | |
| 805 | State Rate * (1 – Federal Rate) | 10.A.02 |
| 806 | b. The Effective State and Federal Tax Rate is the calculated by | |
| 807 | Federal Rate + Effective State Rate | 10.A.03 |

- 808 c. The Net Income After Taxes on Income is
 809 1 – Effective State and Federal Tax Rate 10.A.04
 810 d. The Pre-Tax WACC will be calculated based on the weighted costs of debt and equity, as approved in base distribution rate
 811 cases from time to time.

812 **PROPERTY PURCHASES**

- 813 Any property purchases are reflected in the revenue requirements on a yearly basis with
 814 Cost of Property * WACC 10.A.05
 815 and are not inflation adjusted over time

816 **PROGRAM COST**

- 817 Program costs (yearly and one-time) are added to the revenue requirements of the year they are incurred and include poten-
 818 tially applicable utility incentive amounts.
 819 Yearly Program Cost * (1 + State Specific Earnings Rate) 10.A.06
 820 Program costs are not inflation adjusted over time

821 **O&M COST**

- 822 O&M (or OpEx) costs to the company are a direct pass through to the revenue requirements, they do however increase by the
 823 inflation rate on a yearly basis.

824 **ASSET REVENUE**

- 825 If the NWA solution provides a revenue stream that can be set against its cost, the annual revenue will be subtracted from the
 826 annual O&M cost.

827 **B. MACRS**

828 **MACRS 7 YEARS (363 - STORAGE BATTERY EQUIPMENT)**

829 **Table 6: 7 Year MARCS**

Year 1	Year 2	Year 3	Year 4	Year 5	Year 6	Year 7	Year 8
14.29%	24.49%	17.49%	12.49%	8.93%	8.92%	8.93%	4.46%

830 **MACRS 5 YEARS (344/345 - SOLAR PANELS, INVERTERS, GENERATORS)**

831 **Table 7: 5 Year MARCS**

Year 1	Year 2	Year 3	Year 4	Year 5	Year 6
20.00%	32.00%	19.20%	11.52%	11.52%	5.76%

832 MACRS 20 YEARS (344/345 - SOLAR PANELS, INVERTERS, GENERATORS)

833 Table 8: 20 Year MARCS

Year 1	Year 2	Year 3	Year 4	Year 5	Year 6	Year 7	Year 8	Year 9	Year 10	Year 11	Year 12	Year 13	Year 14	Year 15	Year 16	Year 17	Year 18	Year 19	Year 20	Year 21
3.75%	7.22%	6.68%	6.18%	5.71%	5.29%	4.89%	4.52%	4.46%	4.46%	4.46%	4.46%	4.46%	4.46%	4.46%	4.46%	4.46%	4.46%	4.46%	4.46%	2.23%

834 C. ASSUMPTIONS BY ENTITY

835 The NWA Framework will incorporate entity-specific values, where appropriate, for inputs into the revenue requirement cal-
 836 culation including property tax expense, state income tax expense, capital structure, cost of debt, equity, and preferred stock,
 837 and Energy Efficiency performance incentive levels.

838

839 **11. REVENUE ESTIMATION MODEL**

840 As part of the NWA Framework, potential revenue streams which can be generated through DER resources can be considered.

841 **A. REGIONAL NETWORK SERVICE (RNS) AND LOCAL NETWORK SERVICE (LNS)¹⁵:**

842 The RNS Rate is the rate applicable to Regional Network Service to affect a delivery to load in a particular Local Network, as
843 determined in accordance with Schedule 9 to the OATT.

844 LNS is the network service provided under Schedule 21 and the Local Service Schedules to permit the Transmission Customer
845 to efficiently and economically utilize its resources to serve its load.

846 As part of the NWA Framework and Tool, the RNS and LNS values will not be considered as an input when evaluating NWAs
847 only, due to the following considerations:

- 848 a. The total volume of RNS and LNS cost on the transmission system remains the same, any reduction of those costs at one
849 specific utility will result in an uptake of cost with all other utilities. From a regulatory standpoint, this favoring of one
850 customer base over another is in the eyes of the EDCs not conducive to achieving the most cost-effective solution for all
851 ratepayers
- 852 b. The Framework and Tool base their cost benefit analysis on the impact on Revenue Requirements, both the LNS and RNS
853 values cannot be realized as an impact on the Revenue Requirements for a specific solution, therefore should not be con-
854 sidered.
- 855 c. In the medium and long term, Eversource expects a large-scale uptake of storage on the ISO-NE System. With large quan-
856 tities of flexible resources, it is to be expected that most, if not all utilities will optimize dispatch against LNS/RNS cost,
857 effectively flattening peak loads. As a result, any benefit that might have been had in the early days will disappear overtime.
- 858 d. For BESS, dispatch is solely reserved for managing distribution grid constraints, as such resources need to be held at ready
859 state and can therefore not be used to address these value streams.

860 **B. ISO REGISTRATION MODEL^{16,17,18}**

861 DERs have several options for registering with the ISO New England. However, not all options are acceptable/feasible for DERs
862 listed as NWAs as it significantly limits their ability to act on distribution grid needs. The following options are available.

- 863 a. **SOG:** A generating unit may register and participate in the wholesale market as a Settlement Only Generator if it has
864 capability of less than five MW connected below transmission per OP-14. A SOG does not participate in the day ahead
865 energy market, participated in the real time energy market but without submitting priced energy offers, thus not dis-
866 patched by operations and is not monitored in real time. An SOG can participate in the capacity market, in the regulation
867 market as an alternative technology regulation resource, ATRR, and not in the reserve market.

¹⁵ https://www.iso-ne.com/static-assets/documents/2019/10/transmission_planning_improvements.pdf

¹⁶ https://www.iso-ne.com/static-assets/documents/rules_proceeds/operating/isone/op14/op14_rto_final.pdf

¹⁷ https://www.iso-ne.com/static-assets/documents/rules_proceeds/operating/isone/op18/op18_rto_final.pdf

¹⁸ <https://www.iso-ne.com/participate/support/glossary-acronyms/>

- 868 b. **MG:** Modelled Generation is any generating unit participating in the wholesale market whose capability is greater than 5
869 MW connected at any voltage level or below 5 MW connected to transmission must register as a Modeled Generation. A
870 MG may participate in the day ahead energy market (must if it has a capacity supply obligation from the capacity market),
871 must make priced energy offers in the real time energy market, and have appropriate telemetry per OP-18 so operations
872 can dispatch and monitor output. A MG can participate in the capacity, reserve and regulation markets provided the unit
873 meets applicable technical requirements.
- 874 c. **LR:** A Load Reducer is any operating generating unit not registered as a generating unit to participate in the wholesale
875 energy, reserves or regulation markets. A load reducer may participate in the regulation market as an ATRR.

876 **Note:** For a DER to be considered as an NWA, the EDC's NWA dispatch always takes precedent over the ISO's dispatch for two
877 reasons:

- 878 a. The ISO has a larger pool of resources to draw upon with a statistical assumption of compliance allowing it to address
879 issues with a level of non-response from assets whereas the EDC with its limited NWA resources behind a single constraint
880 relies on the asset's participation.
- 881 b. Failure to comply with the EDC's NWA dispatch can result in a localized power system failure resulting in customer outages
882 and the DER being offline for either one purpose.

883 The NWA Framework therefore applies the following considerations

- 884 a. In general, **for all NWA assets**, the preferred mode to register with the ISO is SOG or LR. While registration as MG provides
885 more access to market value streams, it requires strict dispatch schedules and steep penalties for non-compliance of those
886 schedules. With the primary objective of the asset being distribution system reliability and ISO and distribution system
887 needs not always aligning, this would cause a conflict of interest with potentially critical amounts of penalties incurred as
888 the distribution system dispatch would always take precedence. The associated risk with such a participation cannot be
889 modeled precisely and therefore does not lend itself as a reliable revenue stream.
- 890 b. In the event that storage is used as a grid resource and while owned by an EDC cannot participate in energy markets, it
891 could be treated as a load reducer. In this case, the Framework looks only at the energy losses in the charging and dis-
892 charging cycle as the battery would charge at retail and discharge at retail, not being allowed to make any revenue. (all
893 SOG registered storage assets charge and discharge at wholesale cost)

894 **Note:** This limits the asset size to 5MW as any assets above this threshold are required to be a MG

895

896

C. ISO MARKET PARTICIPATION

897

In order to estimate any applicable revenue streams from different NWA resources which can be taken into consideration for offsetting revenue requirements to the customer, the NWA Framework assumes the following Table 9 highlighting how each resource type, depending on its registration model, will can participate.

900

Table 9: Applicable Energy Market Revenue Models by Type of DER

NWA	ISO Registration Model	Day Ahead Energy Markets	Real Time Energy Markets	Forward Capacity Markets
Large Scale Solar DG	SOG	NA	Applies	Applies
	MG	Applies	Applies	Applies
	LR	NA	NA	NA
Large Scale Storage	SOG	NA	Applies	Applies
	MG	Applies	Applies	Applies
	LR	NA	NA	NA
Energy Efficiency	on peak demand	NA	NA	Applies
	seasonal peak demand	NA	NA	Applies
Fuel Cell & CHP	SOG	NA	Applies	Applies
	MG	Applies	Applies	Applies
	LR	NA	NA	NA

901

Note: Due to limitations on the dispatch of NWA contracted DER, MG is not being considered.

902

903 D. ISO MARKET ASSUMPTIONS

904 The following Chapter provides a brief overview of the markets assumed accessible by the NWA Framework for DERs (excludes
905 markets accessible through MG market participation)

906 REAL-TIME AND DAY AHEAD MARKET (WHOLESALE ENERGY)

907 The NWA Framework assumes a levelized wholesale energy price for all transactions and calculations over the financial plan-
908 ning horizon including annual inflation.

909 For simplicity reasons, the NWA Framework bundles the Real-Time and Day-Ahead Energy Markets into a single wholesale
910 energy value for both MG and SOG registered DERs.

911 The NWA Framework defaults the levelized wholesale energy price to $40 \frac{\$}{\text{MWh}}$

912 FORWARD CAPACITY MARKET (FCM)¹⁹

913 Due to various policy and market drivers, future supply and demand projections in New England and associated capacity market
914 price formation is continuously evolving. We therefore believe using any forward projection of capacity prices provides a false
915 sense of precision. But for purposes of accounting for some capacity market value, the NWA Framework applies the last FCM
916 clearing price of \$2.61 per kW-mo as a forward projection, subject to inflation.

917 E. DER REVENUE TIMELINES

918 As outlined early on, the NWA Framework requires DERs participating as NWA's to be under the EDC's dispatch control to
919 ensure reliable operations at any point in time, if they are not EDC owned. During the duration of the NWA contract from the
920 time of the NWA Solution goes live until the deployment of the traditional solution at the end of the deferral horizon, any NWA
921 DERs are assumed to be under EDC dispatch. As a result, they might lose market revenues. This will specifically be the case with
922 storage systems. However, especially for storage assets, DERs can be freed from this responsibility at the point the deferral of
923 the traditional investment is completed. Once the traditional upgrade is in place to no further require NWA services, the battery
924 could be utilized for bulk services.

925

926

927

928

929

930

¹⁹ https://www.iso-ne.com/static-assets/documents/2021/02/20210211_pr_fca15_initial_results.pdf

931 **F. DER REVENUE**

932 The NWA Framework allows consideration of multiple NWA revenue streams. Even with several of the NWA solutions modeled
 933 as utility owned and operated, it is assumed that these resources can produce a revenue stream through e.g. generation of
 934 electric energy.

935 **SOLAR PV**

936 The NWA Framework allows for the following revenue streams from solar PV resources:

937 a. **Wholesale Energy Revenue:** Applicable to SOG registered solar plants as well during and after the NWA dispatch, revenue
 938 from the wholesale energy market is calculated in the tool using the assumption of an annual generation of

939
$$\int \left[\varepsilon * \frac{I_{\text{Clear Sky Irr}}(t)}{1000 \frac{\text{W}}{\text{m}^2}} * \lim_{P_{\text{AC}}^{\text{max}}} \left(P_{\text{DC}}^{\text{max}} \right) \right] dt \quad 11.E.01$$

940 Where kW_{DC} represents the installed DC Panel Power. The Framework assumes a uniform reduction of solar irradiance by
 941 ε over the entire year

942 b. **Net Metering:** Similar to wholesale revenue, the annual generation is calculated and applied to retail prices for net metered
 943 assets, which are registered as LR.

944 c. **State Sponsored Generation Credits:** Applicable depending on the state. To account for government funding of generation
 945 sites, the NWA Framework accounts for the presence of a generation credit in $\frac{\$}{\text{kWh}}$. The generation credit is applied to the
 946 revenue estimation as a cap for what PV solar resources can earn on their energy. Therefore, the additional value gener-
 947 ated equals the difference of the generation credit and what was already earned through wholesale energy market reve-
 948 nue.

949
$$\min_{=0} (\$_{\text{Gen Credit}} - \$_{\text{Wholesale Energy}}) \quad 11.E.02$$

950 d. **Forward Capacity Market Revenue:** Applicable to SOG registered solar plants. Revenue from the forward capacity market
 951 is calculated using the default assumption that solar is issued a capacity credit of 18% of the installed AC power.

952 **Note:** BTM solar is not attributed any revenue streams in the NWA Framework as the approach provides for the EDC paying a
 953 kWh-based subsidy to residents to install solar. Therefore, any revenue streams from the solar installation end up with the
 954 customer, and the per kWh payments remain directly impactful on the EDC's revenue requirements.

955 **ENERGY EFFICIENCY²⁰**

956 The NWA Framework provides an FCM revenue for Energy Efficiency. Hereby, an Energy Efficiency measure that has been
 957 completed can generate FCM revenue for 1 to 25 years (averaging 8 years, given the current measure mix).

958 a. **Forward Capacity Market Revenue:** Energy Efficiency measures can be registered with the FCM while providing a capacity
 959 value for two windows throughout a year

- 960 • April to November (Summer)
- 961 • December to March (Winter)

962 The capacity values accounted for in each window are based on one of two methods of calculation

- 963 • On-Peak:

²⁰ <https://www.iso-ne.com/markets-operations/markets/demand-resources/about>

- 964 i. To calculate the summer on-peak value, the energy efficiency capacity impact on an hourly basis for all
 965 non-holiday weekdays from June to August between 1 and 5 pm are added up and divided by the total
 966 number of hours.
- 967 ii. To calculate the winter on-peak value, the energy efficiency capacity impact on an hourly basis for all
 968 non-holiday weekdays from December to January between 5 and 7pm are added up and divided by the
 969 total number of hours.
- 970 • Seasonal Peak:
 - 971 i. To calculate the summer seasonal peak value, the energy efficiency capacity impact is assessed on non-
 972 holiday weekdays in hours when the real-time system hourly load is equal to or greater than 90% of the
 973 system peak-load forecast during June – August timeframe.
 - 974 ii. To calculate the winter seasonal peak value, the energy efficiency capacity impact is assessed on non-
 975 holiday weekdays in hours when the real-time system hourly load is equal to or greater than 90% of the
 976 system peak-load forecast during December – January timeframe.

977 DEMAND RESPONSE

978 Demand Response is not considered for ISO based revenue streams in the NWA Framework.

979 CONSERVATION VOLTAGE REDUCTION

980 Conservation Voltage Reduction is not considered for ISO based revenue streams in the NWA Framework.

981 BATTERY STORAGE

982 a. Wholesale Energy Revenue:

983 a. During NWA Dispatch

- 984 i. **LR:** An LR Storage charges and discharges at retail rate, which is constant, and can therefore not generate
 985 any revenue.
- 986 ii. **SOG:** An SOG Storage charges and discharges at wholesale energy cost. Since the Framework assumes a
 987 levelized wholesale energy cost, no value is yielded. Therefore, the Framework assumes an arbitrage
 988 value which is defaulted to 40\$/MWh. The number of yearly constraint events yields to amount of energy
 989 discharged.

990
$$\sum_{\text{Events/year}} t * Q_{\text{Discharged}} * \frac{\$ \text{Arbitrage}}{\text{MWh}} \quad 11.E.03$$

991 b. **After NWA Dispatch** Applicable SOG, battery storage systems charge at wholesale energy rates, and discharge at
 992 wholesale energy rates. Using 11.E.03 the tool provides inputs for assumed annual cycles after the NWA dispatch
 993 contract is completed with a default value of 365.

994 b. **State Sponsored Generation Credits:** Applicable depending on state. To account for government funding of storage sites,
 995 the NWA Framework accounts for the presence of a generation credit in $\frac{\$}{\text{kWh}}$. The generation credit is applied to the reve-
 996 nue estimation as a cap for what resources can earn on their energy. Therefore, the additional value generated equals the
 997 difference of the generation credit and what was already earned through wholesale energy market revenue.

998
$$\min_{=0} (\$_{\text{Gen Credit}} - \$_{\text{Energy Revenue}}) \quad 11.E.04$$

999 c. **Forward Capacity Market Revenue:** Applicable for SOG resources after the completion of an NWA contract.

1000 **Note:** BTM battery installations managed through a utility program will not be considered for additional ISO based revenue
 1001 streams as any revenue from the assets stays with the customer and the EDC is not acting as a virtual power plant (VPP) but
 1002 rather has contracts only for the NWA dispatch requirements.

1003 **Note:** If the Battery is operated as a LR it cannot participate in wholesale energy markets and therefore will charge and dis-
1004 charge at retail rates making it impossible to yield an arbitrage, as those rates are not time dependent. Cost of operating the
1005 battery therefore is defined by the energy losses and the retail cost of energy.

1006 FUEL CELL & CHP

1007 As Fuel Cells and CHP are part of targeted energy efficiency programs, any revenue generated through heat or electric genera-
1008 tion flows directly to the customer.

1009 EMERGENCY GENERATION

1010 a. **Wholesale Energy Revenue:** The only revenue option assumed for emergency generators is the wholesale value of the
1011 energy produced during dispatch. Hence, the total assumed revenue from emergency generation equals

1012 $\sum_{\text{Events/year } t} P_{\text{installed}} * \frac{\$_{\text{wholesale}}}{\text{MWh}}$ 11.E.05

1

2

EVERSOURCE

3

Loudon Station

NWA SCREENING OF LOUDON STATION TO DEFER A CAPITAL INVESTMENT

Gerhard Walker Dr.
Principal Engineer – Distribution System Planning

Roshan Bhakta
Manager – Energy Efficiency

Matthew Cosgro
Senior Engineer – Distribution System Planning

4
5
6
7
8
9
10
11
12
13
14
15
16
17
18
19

[LEFT INTENTIONALLY BLANK]

20

EXECUTIVE SUMMARY

21 This Non-Wires Alternatives (NWA) Screening Study for the Loudon Station was conducted by Eversource as part of its
 22 March 31st 2021 supplemental filing for the 2020 Least Cost Integrated Resource Plan (LCIRP), filed for approval with the New
 23 Hampshire Public Utilities Commission in September 2020 pursuant to RSA 378:38 and Order No. 26,362. The objective of the
 24 study is to evaluate the feasibility of using distributed energy resources (DERs) such as Energy Efficiency (EE), Demand Response
 25 (DR), Combined Heat and Power (CHP), Behind the Meter Battery Energy Storage Systems (BTM BESS), and utility scale assets
 26 to defer the need for a traditional substation upgrade at Loudon station. Loudon Station was previously identified in the LCIRP
 27 filing as a suitable candidate station due to the type of the violation (capacity), the size of the violation (< 1MW), the need date
 28 (> 3 years out) and the age/condition of the transformers (green/yellow).

29 Loudon Station is a two-transformer (“double ended”), non-bulk distribution substation¹ with transformers 31W1 (5.25 MVA)
 30 and 31W2 (3.36 MVA), each supplying a single feeder. Both transformers are currently forecasted to exceed their nameplate
 31 rating in 2021 under N-0 conditions. The currently proposed traditional solution upgrade calls for the replacement of the double
 32 ended station with a single ended 12.5 MVA Transformer supplying both feeders at an estimated total project cost of **\$6.5 mil-**
 33 **lion**. If a deferral by five (5) years to the end of the forecasting horizon is possible, a cumulative net present value of **\$1,657,186**
 34 would be achieved.

35 The load analysis showed that both transformers have long duration, low frequency, summer peaks centered around the events
 36 at the New Hampshire Motor Speedway (low load factor). Otherwise, both transformers show a fairly even, fairly low average
 37 load (low utilization) across the entire year. Particularly noteworthy in the Loudon Station case is the fact that the high-load
 38 events can be predicted based on the racetrack’s event schedule a year in advance.

39 Given that Loudon Station currently is as a double ended station, any NWA solution would require a deployment on both
 40 transformers. This influences the decision and the cost to upgrade from a double ended station to a single ended system.
 41 Furthermore, the elevated long-term asset health index score of 0.46 from Eversource’s PTX tool² for 31W2 indicates that
 42 significant deferral past the forecasting horizon increases the safety and reliability risk. The benefit-cost ratios of the options
 43 considered for Loudon are shown in Figure 1 below. **If an NWA solution is considered suitable, the most cost-effective NWA**
 44 **solution consists of three (3) mobile generation units operating for 3 to 6 days a year, at a nominal annual cost of \$194,928.**

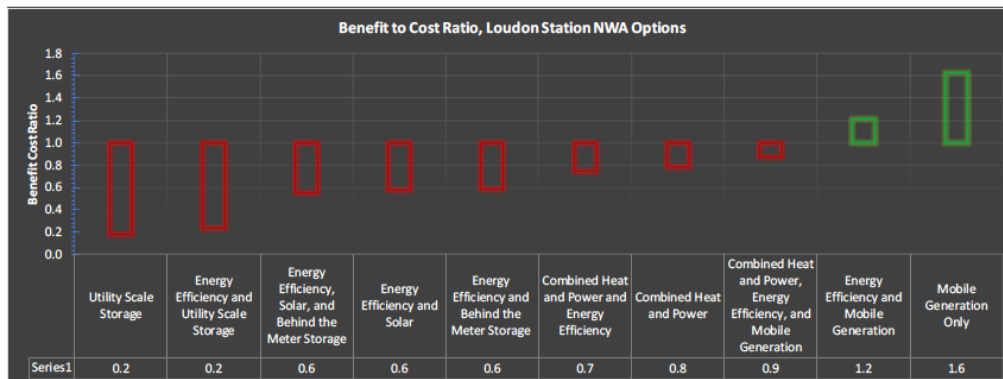

45
46

Figure 1: Benefit to Cost Ratio of Loudon Station NWA Options

¹ A non-bulk station is a station that is typically served by an upstream bulk station via 35-kV class lines rather than by transmission lines. In the case of Loudon, each transformer is supplied by 34 5 kV lines out of Oak Hill and Chichester bulk stations.

² Per Eversource’s data-driven transformer replacement strategy, based on EPRI’s PTX tool (see Appendix B-6 in the Supplemental Filing), any station transformer with a long-term asset health index above 0.5 has experienced loss of useful life, is a potential replacement candidate, and will therefore not be considered as an NWA candidate.

47 LOUDON STATION BASIC INFORMATION

48 Specifics about Loudon Station

49 **Transformer 31W1**

50	○ Rating:		5.25 MVA
51	○ Asset Health Index ³ :		0.08
52	○ Feeders Supplied:		1
53	○ Total installed AC Solar DG:		0.68 MW
54	○ 2019 Net Peak:		5.01 MW
55	○ 2019 Gross Peak ⁴ :		5.53 MW

56 **Transformer 31W2**

57	○ Rating:		3.36 MVA
58	○ Asset Health Index:		0.46
59	○ Feeders Supplied:		1
60	○ Total installed AC Solar DG:		0.27 MW
61	○ 2019 Net Peak:		3.32 MW
62	○ 2019 Gross Peak:		3.44 MW



64 **Figure 2: Loudon Non-Bulk Station, Loudon NH**

65 ³ A health index greater than 0.5 equals a turn insulation drop below 400. (new transformers are at ~1000). Industry/literature accepted practice is that <400 is a replacement candidate.

⁴ Gross Calculations achieved using historic 15 min solar irradiance data for 2019 from SolarAnywhere as well as an assumed DC/AC ration of 1.2 based on historic data collected in an Eversource Study (see Appendix A)

REDACTED

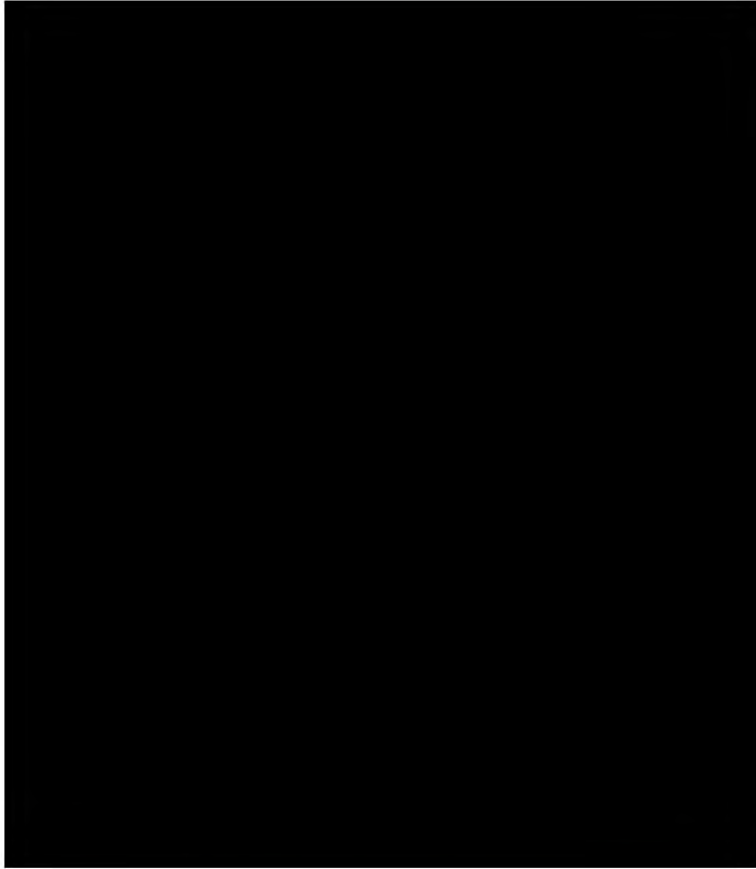

66

67

Figure 3: One Line Diagram for Loudon Station showing both 31W1 and 31W2



68

69

Figure 4: Loudon Station Location on Google Map

70 Prior to the evaluation of possible NWA scenarios and proposing a station redesign, Eversource evaluated a variety of tradi-
71 tional solutions. Each of these solutions are typical options EDCs evaluate to address capacity constraints.

- 72 1. **Load Transfer:** Transfer for major loads/load pockets to other feeders, stations, or transformers to offload Loudon Sta-
73 tion Transformers.
- 74 ○ There are no adjacent Eversource distribution lines from other supplies such as other substations (i.e., the back-
75 bones aren't adjacent to other backbones from different stations) and a load transfer within the station isn't
76 applicable as both transformers have overloading issues at the same time.
 - 77 ○ Where the Loudon circuits do meet other distribution lines, the lines are small conductor, single-phase lines
 - 78 ○ Where the 34.5 kV line does cross the feeder coming of transformer 31W2 allowing to hang a 34-12kV pole-top,
79 the feeder is a small conductor with single-phase taps.
- 80 2. **Voltage conversion:** Convert a major customer load from a 12.47 kV to a 34.5 kV customer to offload Loudon Station.
- 81 ○ The two 12.47 kV circuit backbones radiate north/south away from the 34.5 kV supply line.
 - 82 ○ Any conversion would require new distribution line construction to reach customers.
- 83 3. **Transformer replacement:** Replace the existing transformers with new, larger equipment
- 84 ○ This is the proposed traditional solution; upgrade the substation with a single 34.5-12.47 kV transformer (12.5
85 MVA) to replace both existing transformers, which is enough to carry the entire station (W1 and W2).
- 86 4. **New 34.5-12.47 non-bulk source:** The addition of a new substation or adding of a third transformer and feeder at
87 Loudon
- 88 ○ The standard equipment for a third transformer would be a 12.5 MVA transformer which is equal to the trans-
89 former replacement solution, and therefore would not yield any benefits to replacing the substation.
 - 90 ○ Building a third feeder entails considerable line construction to bring in that third feeder to offload key loads
91 from both circuits.
 - 92 ○ The circuit backbones heading north/south do not lend themselves for a new substation site with minimal distri-
93 bution line work.

94 Outside the traditional solutions, Eversource considered operating both transformers in parallel (31W1 and 31W2). However,
95 parallel operation of transformers brings significant challenges from a protection standpoint, therefore:

- 96 ○ Non-bulk transformers historically aren't operated in parallel due to protection and fault current implications
 - 97 ○ Doing so would require extensive protection and coordination engineering and relay protection driving up the
98 cost significantly
 - 99 ■ Especially when protecting the transformers for an N-1 loss of either one transformer would require
100 installation of a transfer trip scheme to a remote recloser, or to shed excessive load.
 - 101 ■ Remote reclosers and transfer trip schemes are additional cost drivers with the resulting solution being
102 more expensive than the replacement option
- 103

104 HISTORIC LOAD AND FORECASTS

105 TRANSFORMER 31W1 LOAD ANALYSIS

106 Transformer 31W1 supplies the New Hampshire Motor Speedway which results in a very long duration, low frequency, and
 107 sharp load peak every time that racetrack has a major event. The peak seen below in Figure 5, is due to the NASCAR event in
 108 summer 2019. Figure 6 shows the
 109 load duration curve of net load on
 110 the station. These data show that
 111 the net load at the station is less
 112 than 4 MW and well below the
 113 5.25 MVA nameplate rating in
 114 99.6% of all measured 15 min
 115 time intervals. When designing an
 116 NWA solution, this will be im-
 117 portant as the solution will re-
 118 quire a very targeted and high-
 119 power output at low annual fre-
 120 quency.

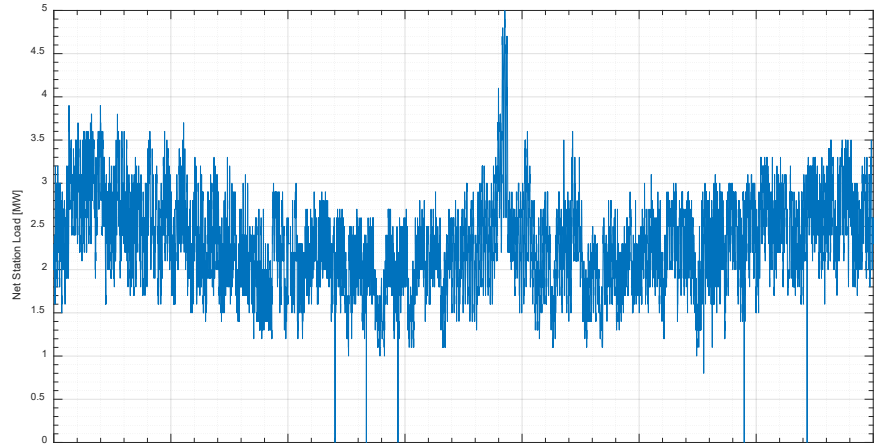

Figure 5: 2019 Time Series Net Load Data at 31W1 Loudon Station

121 Further analysis of 31W1 using
 122 the installed solar DG and historic
 123 irradiance profiles yields the gross
 124 load profile for 2019 shown in Fig-
 125 ure 7 below. To calculate the gross
 126 load profile, the following ap-
 127 proach was applied to estimate
 128 the historic, hour-by-hour solar
 129 output of all panels.

130
$$\max_{P_{AC}} \left[\frac{I_{Irr}(t)}{1000 \frac{W}{m^2}} * P_{DC} \right]$$

131 With $P_{DC} = 1.2 * P_{AC}$ representing
 132 the assumed ratio between the DC
 133 and AC installed ratings⁵. The PV
 134 output is limited by P_{AC} .

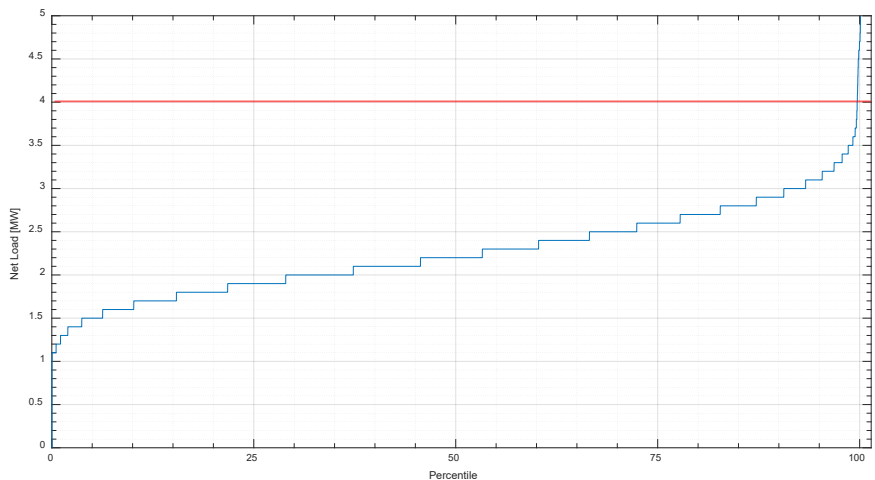
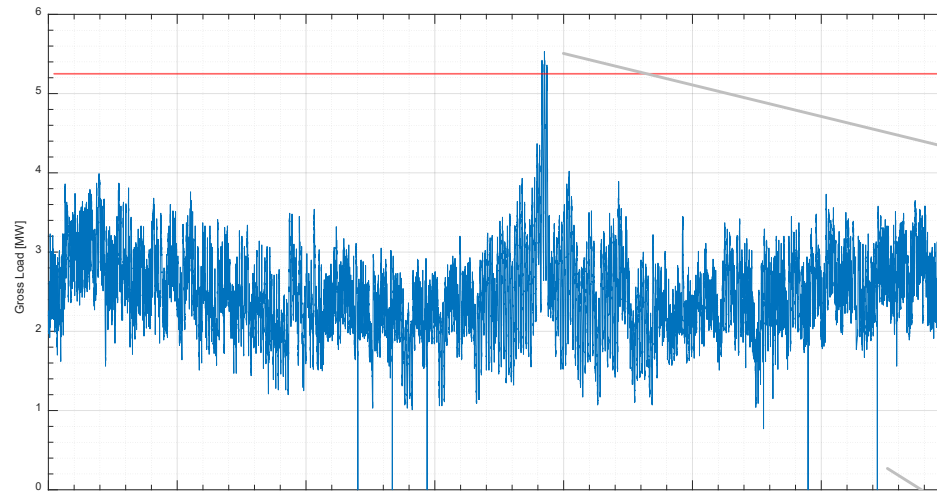

Figure 6: 2019 Load Percentiles Net Load Data at 31W1

135 The key takeaway from the gross
 136 load analysis is that 31W1 does not have any gross load issues that are unrelated to the New Hampshire Motor Speedway
 137 events. Any NWA solution design will need to be geared towards these load requirements.

⁵ Based on a study conducted on installed DG across CT, see Appendix A



Underlying gross load exceeds the station capacity, depending on solar output; this peak is masked in net load.

138

139

Figure 7: 2019 Time Series Gross Load Data at 31W1 Loudon Station

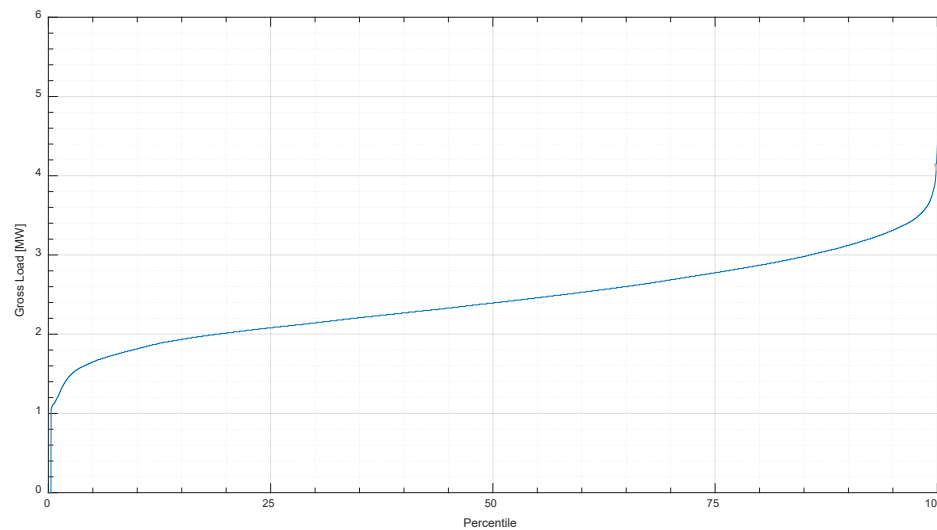

Zero measurements indicate missing or faulty data from recordings.

Only a small number of incidents with gross load above 4 MW.

140

141

Figure 8: 2019 Load Percentile Gross Load Data at 31W1

142 TRANSFORMER 31W1 FORECAST AND CAPACITY GAP ANALYSIS

143 Eversource produces annual system forecasts for all bulk stations, which in turn are then broken down to the non-bulk stations.
 144 Table 1 shows the forecasts for 2020 to 2029 for Loudon 31W1. This analysis is purposely based on the 2019 data to exclude
 145 the temporary impacts of the COVID pandemic of 2020. Eversource expects that load shapes will more closely resemble the
 146 pre-pandemic stage in the long term.

147 **Table 1: Non-Bulk Forecast at Loudon 31W1**

Transformer	Non-Bulk Substation	All Time Peak MW	2019 Peak MW	90/10 Non-Bulk Forecast Including Spot Loads									
				2020	2021	2022	2023	2024	2025	2026	2027	2028	2029
Loudon 31W1	Loudon	5.06	5.06	5.53	5.56	5.59	5.60	5.62	5.64	5.66	5.68	5.70	5.73

149 The forecast from Table 1 refers to the net load at 31W1 Loudon. This means, it relies on similar solar contribution to the
 150 transformer’s load in all of the forecasted years. A study conducted by Eversource on the correlation of high relative irradiance
 151 to peak load condition, however, clearly identified that this is not always the case. It was concluded from that study, that during
 152 summer months (June – August), 10% of the time the relative solar irradiance drops solar generation to 24.1% of the nameplate
 153 output or less⁶. As a result, Eversource has updated its planning criteria in the Distribution System Planning Guide to account
 154 for such eventualities that a high load condition coincides with low solar output. Table 2 shows the Minimum Weather Adjusted
 155 Solar Output factor, which is applied to the clear sky profile for all solar capacity calculations.

156 **Table 2: Minimum Weather Adjusted Solar Output Factor**

	Winter	Shoulder	Summer
10 th percentile relative irradiance	16.8%	18.1%	24.1%

157 To create the load curves for 31W1 Loudon, the following steps were conducted:

- 158 a. Determine relative peak increase based on forecasts relative to the base year
- 159 b. Create the historic gross load profile using the historic irradiance data
- 160 c. Create the new gross load forecasted profiles
- 161 d. Subtract the Minimum Weather Adjusted Solar Output from the forecasted
- 162 gross load profiles using seasonal clear sky profiles and the values from Table 2

NOTE: *The Minimum Weather Adjusted Solar Relative Irradiance is NOT the Clear Sky Irradiance used to calculate solar output. It is the value to which the Clear Sky Irradiance is reduced at any 15min interval over the entire year. As such, a 5pm afternoon value of 500W/m2 would then be reduced to just below 100W/m2 during summer months.*

163 Using the NWA Screening Tool, the forecasts, gross loads, and minimum weather ad-
 164 justed solar output values, it was possible to create 8760 net load profiles for each of
 165 the transformers. For each forecasted 8760 profile, three analyses were conducted:

- 166 a. Peak Day Shape
- 167 b. Number of Capacity Constraint Events
- 168 c. Size of Capacity Events

169 Figure 9 below shows the forecasted shapes for peak days for the next 10 years. Note that there is minimal expected change
 170 in load growth year over year. Also important to note is that given these peaks are based on race events, the peak load condition
 171 starts around 9:30 am, which is atypical for system peaks. More commonly, peaks occur in the late afternoon/evening
 172 timeframe. This results in a very prolonged peak event, lasting 9-10 hours.

⁶ See Appendix B for study results

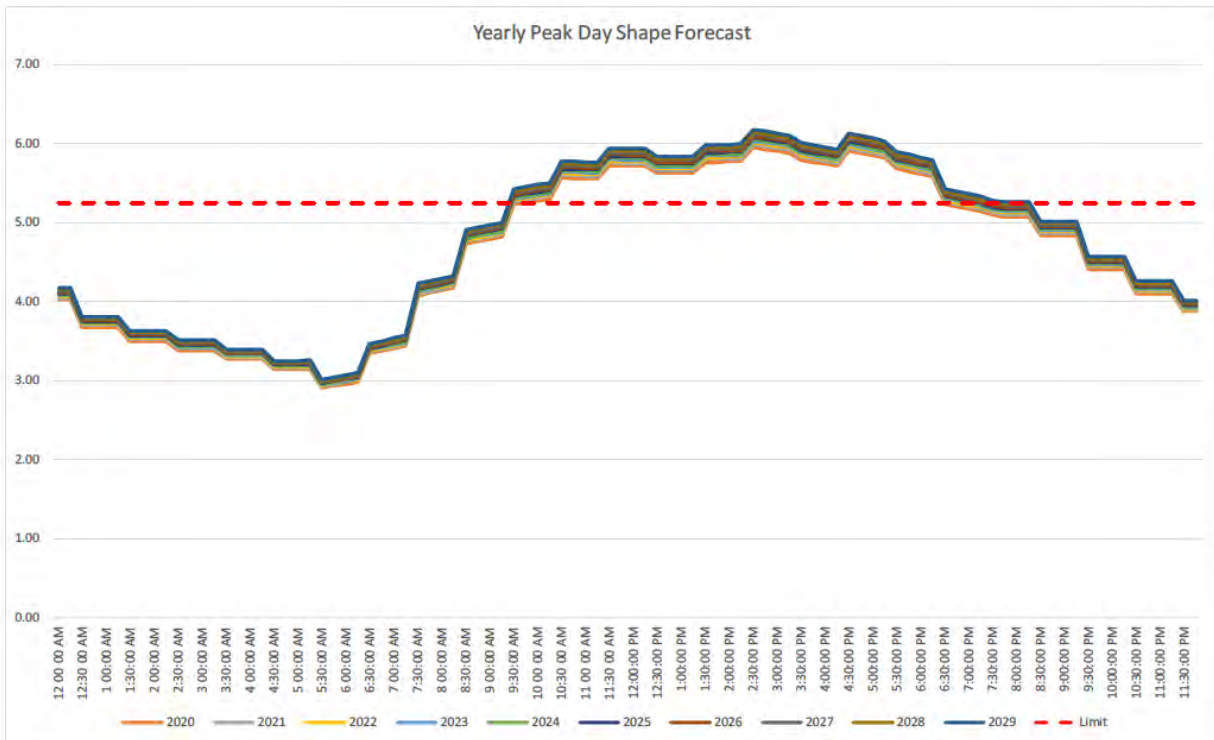

173

174

Figure 9: Forecasted Net Load Shapes for Peak Day by Year at 31W1 from the NWA Screening Tool

175

When looking at the annual distribution of peak events, it is clearly visible when the race events occurred.

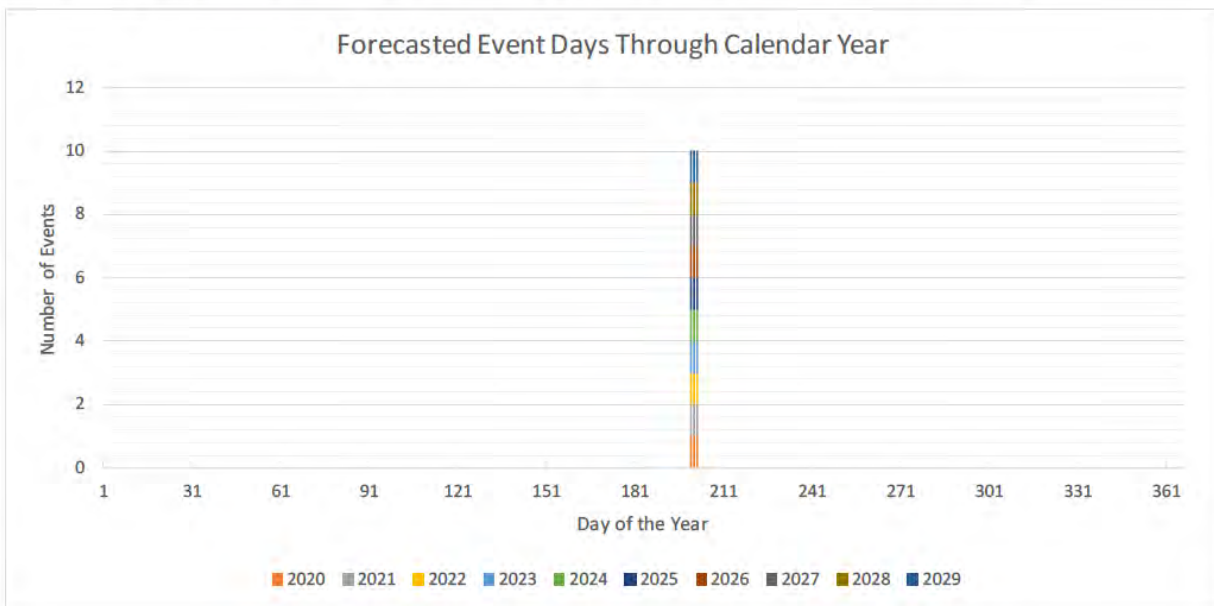

176

177

Figure 10: Peak Event Days for 31W1 by Forecast Year from the NWA Screening Tool

178 When sizing the capacity need, especially when looking at NWA solutions, it is important to understand the frequency, duration,
179 and magnitude of the events. Figure 11 provides answers to all those questions for 31W1. Note that while the maximum con-
180 strained power (MW) (or capacity violation) is relatively low, the energy violation is a 6h+ full time equivalent (typically 2hours,
181 in rare cases 4 hours). This will make designing battery storage solutions very difficult as it drives up battery cell costs.

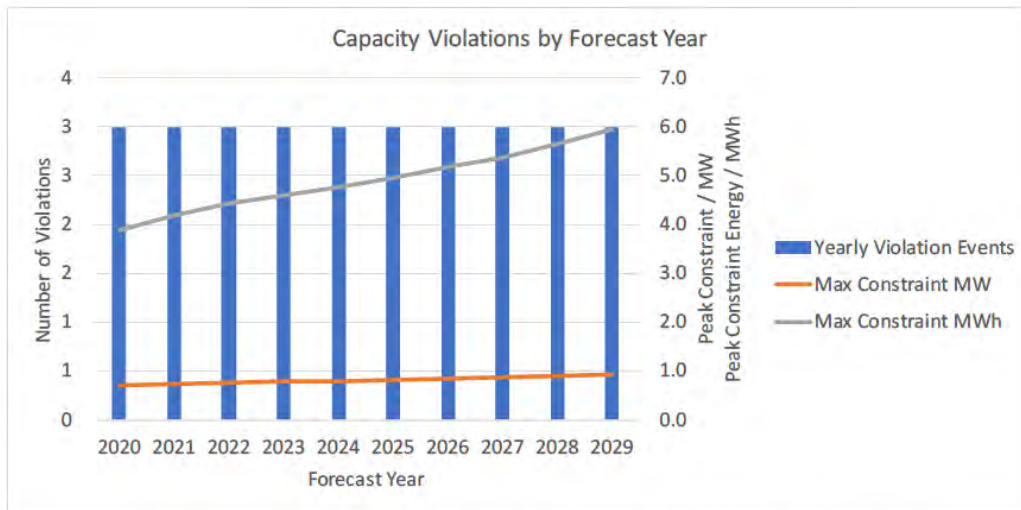

182

183

Figure 11: Capacity Violation Characteristics for 31W1 by Forecast Year from the NWA Screening Tool

184 TRANSFORMER 31W2 LOAD ANALYSIS

185 Transformer 31W2 supplies a wide array of customers, from commercial to resi-
186 dential. Figure 12 shows the time series profile of the loading on the transformer.
187 Similar to the 31W1, this transformer shows very strong peaking events during the
188 summer with a relatively consistent load during the rest of the year. However, un-
189 like 31W1, the peaks are broader with about 98.89% of 15min intervals showing a
190 above 2.5MW.

Note: All calculations on 31W2 are similar to the 31W1 calculations and are not described a second time in this chapter. Graphical results can be reviewed in Appendix E.

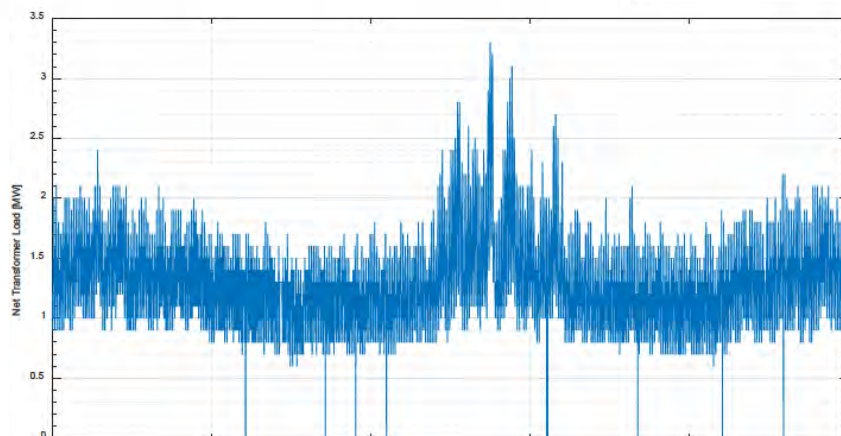

191

192

Figure 12: 2019 Time Series Net Load Data at 31W2 Loudon Station

193 TRANSFORMER 31W2 FORECAST AND CAPACITY GAP ANALYSIS

194 Table 3 shows the forecasts for 2020 to 2029 for Loudon 31W2. This analysis is purposely based on the 2019 data to exclude
195 the temporary impacts of the COVID pandemic of 2020. Eversource expects that load shapes will more closely resemble the
196 pre-pandemic stage in the long term.

197

Table 3: Non-Bulk Forecast at Loudon 31W2

Transformer	Non-Bulk Substation	All Time Peak MW	2019 Peak MW	90/10 Non-Bulk Forecast Including Spot Loads									
				2020	2021	2022	2023	2024	2025	2026	2027	2028	2029
Loudon 31W2	Loudon	3.35	3.35	3.66	3.68	3.70	3.71	3.72	3.73	3.74	3.76	3.77	3.79

198

199 Figure 13 shows the forecasted shapes for peak days for the next 10 years. Noticeably, there is a minimal expected change in
200 load growth. In contrast to 31W1, 31W2 peaks about 3 hours later in the day and retains a peak load condition farther into the
201 evening. It is assumed that due to the fact that 31W2 does not service the racetrack directly, it receives the load influx later on
202 as the event progresses and people head for lunch or stay in town after the event is over in the evening.

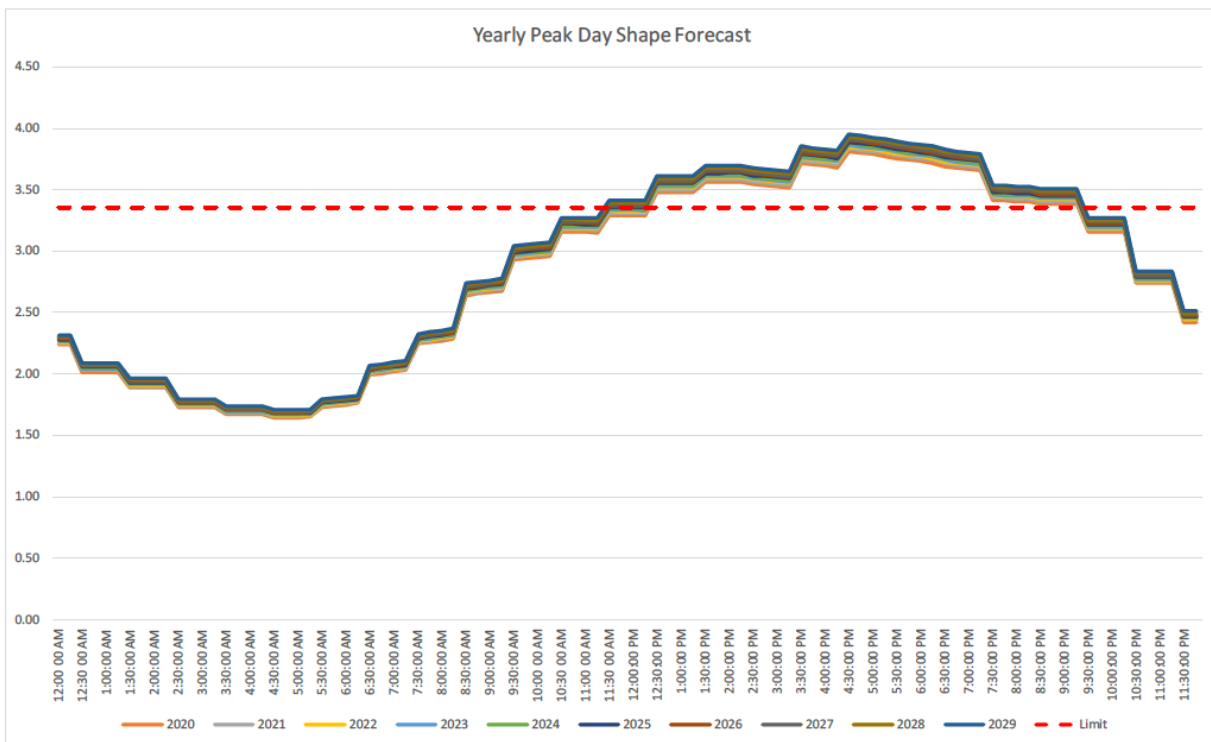

203

Figure 13: Forecasted Net Load Shapes for Peak Day by Year at 31W2 from the NWA Screening Tool

204

205 31W2 also registers more peak event days a year (6 as opposed to 3) than 31W1 as highlighted in Figure 15. The second event
206 appears to be a smaller race event that does not trigger an overload on 31W1 but does on 31W2 due to its smaller size.

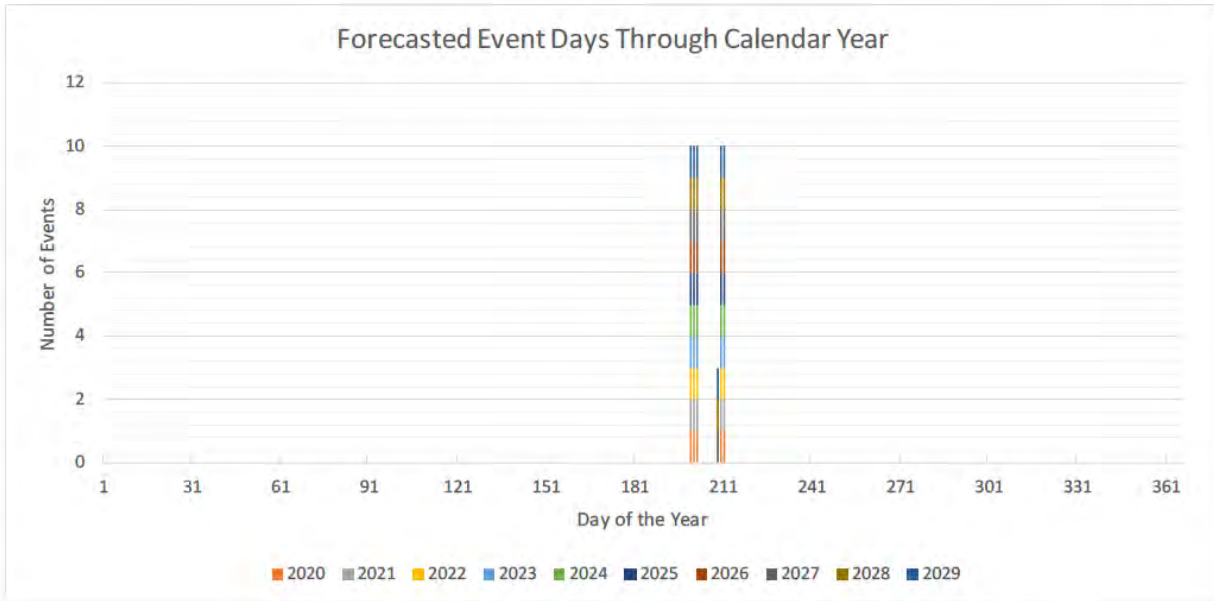

207

208

Figure 14: Peak Event Days for 31W2 by Forecast Year from the NWA Screening Tool

209

While there are more events on 31W2 than 31W1, the general shape remains the same with very low power values but 6h+ equivalent energy needs as shown in Figure 16. Similar to 31W1, this brings design challenges when it comes to BESS.

210

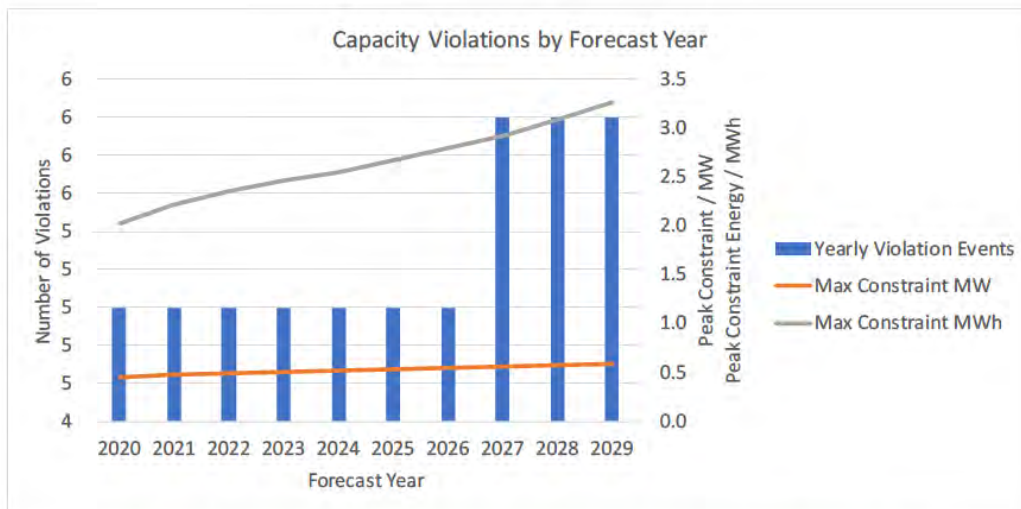

211

212

Figure 15: Capacity Violation Characteristics for 31W2 by Forecast Year from the NWA Screening Tool

213

When comparing the violations at 31W2 to violations at 31W1, the following observations can be made:

214

- 31W2 has more event days than 31W1 which is also visible in the load distribution

215

- 31W2, while having more event days, has significantly smaller violations, yielding only about half the values of 31W1

216

- Both transformers show relatively flat and extended peak events

217

NWA SCREENING

218
219
220

The following chapter walks through a set of technologies considered for deferral of the Loudon Station upgrade. Technologies will be introduced as standalone items and their benefits and possible contributions evaluated. For final solution proposals, please see the next chapter.

221

ENERGY EFFICIENCY SCREENING

222
223
224
225
226
227
228

Eversource's Energy Efficiency Team has conducted a detailed analysis of the Loudon station region, compiling a detailed understanding of the customers and load types in the region. With about half the consumption from residential customers, and the top ten commercial and industrial (C&I) customers making up about 70% of the C&I sector conversion, the possible opportunities are very clear:

229
230
231

- a. Residential EE
- b. Commercial EE and DR programs
- c. BTM Storage Programs

232
233
234
235

A detailed analysis of the data can be found in Appendix C. Figure 16 shows a geographic representation of all metering points at Loudon and their respective annual consumption by size of the dot (The colors only serve to distinguish locations).

236
237
238
239
240
241
242

Eversource's EE Team provided an estimated potential of EE, DR and storage potential on a projected three-year acquisition timeline (Table 4). Values are provided by feeder to specifically allow them to be rolled up by transformer. The EE values provided show an estimated annual savings in kWh which are converted to peak contribution kW by using the annual and daily EE profiles provided in the NWA Framework.

243
244
245
246

The resulting peak EE contributions by category can be reviewed in Table 5 and 6. Note that the seemingly large EE impacts in terms of annual energy savings correspond to relatively low peak contributions because EE provides continuous savings over the entire load profile rather than concentrating on peak periods,

247
Note: All EE values are estimates of potential and might vary based on the willingness of customers to participate in the program.

e.g. a flat reduction of load by 1kW every hour of the year yields more than 8.7 MWhs of Energy Savings.

Specifically, for a very "spiky" profile such as Loudon, EE is not an ideal solution. Its benefit/cost ratio is decreased because benefits are spread across the entire year where the impact is not beneficial for deferring the system upgrade.

252
253
254
255

The projected EE impact on both transformers falls well short of being able to adequately, as a stand-alone solution, address the station's capacity need. However, especially for 31W1, EE has the potential to significantly reduce and shorten the need. Figures 17 and 18 show the impact of EE, assuming that the entire potential in Table 4 can be leveraged. **In conclusion, energy efficiency on its own is not a feasible solution but can be included in combination with other solutions.**

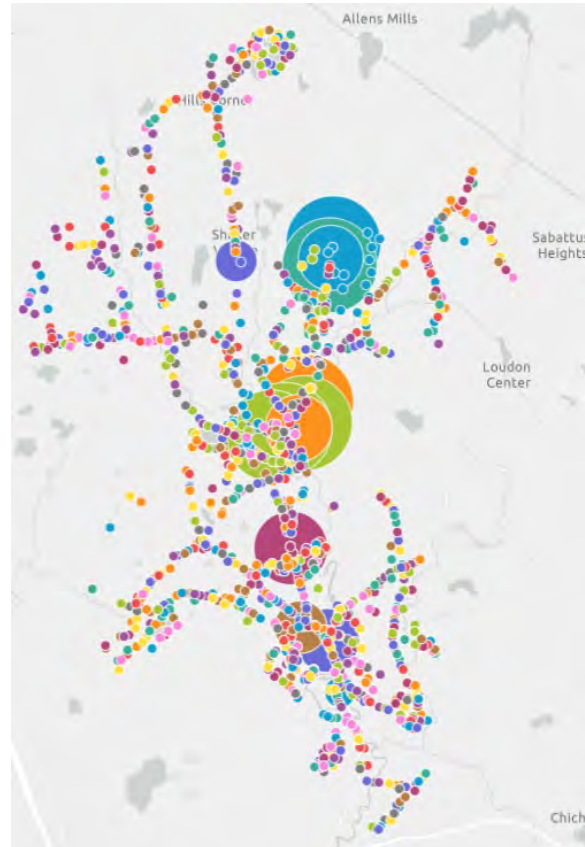

Figure 16: Metering Points at Loudon and Respective Consumption

256

Table 4: Potential Estimation for Loudon Station

		Energy Efficiency												Demand Response & Storage							
		2019 Total Annual		Commercial Lighting (Cum. kWh)			Commercial HVAC (Cum. kWh)			Residential Lighting (Cum. kWh)			Residential HVAC (Cum. kWh)			Potential Summer DR (kW)			Potential BTM Storage (kW)		
		Usage (kWh)	Demand	Year 1	Year 2	Year 3	Year 1	Year 2	Year 3	Year 1	Year 2	Year 3	Year 1	Year 2	Year 3	Year 1	Year 2	Year 3	Year 1	Year 2	Year 3
31W1	1296	20,333,806.8	6,071.2	219,461.4	438,922.8	658,384.1	103,955.4	207,910.8	311,866.2	19,520.0	21,472.0	22,545.6	45,760.0	66,640.0	120,120.0	197.5	395.1	592.6	112.0	600.0	1,250.0
COMMERCIAL	145	11,550,598.9	3,911.7	219,461.4	438,922.8	658,384.1	103,955.4	207,910.8	311,866.2							195.6	391.2	586.8	100.0	500.0	1,000.0
COMPANY USE	1	3,730.0																			
INDUSTRIAL/MANUFACTURING	5	35,975.8	31.8																		
MANUFACTURING ELECTRIC HEAT	1	22,623.8	10.9																		
RESIDENTIAL SPACE HEATING	168	1,299,135.0	303.4										6,720.0	10,080.0	17,640.0						
RESIDENTIAL-NON HEATING	976	7,421,743.3	1,813.4							19,520.0	21,472.0	22,545.6	39,040.0	58,560.0	102,480.0	2.0	3.9	5.9	12.0	100.0	250.0
31W2	1182	11,359,800.7	2,943.8	53,834.6	95,675.6	137,516.5	19,819.4	39,638.8	59,458.2	20,020.0	22,022.0	23,123.1	43,920.0	65,880.0	115,290.0	45.2	90.4	135.6	113.0	600.0	1,250.0
COMMERCIAL	82	2,202,155.6	863.8	41,841.0	83,681.9	125,522.9	19,819.4	39,638.8	59,458.2							43.2	86.4	129.6	100.0	500.0	1,000.0
INDUSTRIAL/MANUFACTURING	1	235.0	6.4																		
OUTDOOR LIGHTING	1	239,873.3	38.6	11,993.7	11,993.7	11,993.7															
RESIDENTIAL SPACE HEATING	97	858,412.6	175.2										3,880.0	5,820.0	10,185.0						
RESIDENTIAL-NON HEATING	1001	8,059,124.2	1,859.9							20,020.0	22,022.0	23,123.1	40,040.0	60,060.0	105,105.0	2.0	4.0	6.0	13.0	100.0	250.0
Grand Total	2478	31,693,607.5	9,015.0	273,296.0	534,596.3	795,900.7	123,774.8	247,549.6	371,324.4	39,540.0	43,494.0	45,668.7	89,680.0	134,520.0	235,410.0	242.7	485.5	728.2	225.0	1,200.0	2,500.0

*Based on the 2019 highest month billed peak (August). Values indicate un-metered / calculated

257

258

259

260

Table 5: 31W1 Energy Efficiency Conversion

Energy Efficiency	MWh	Annual Savings Worksheet	MW
Commercial Lighting	658.4	MWh/year in EE savings equals peak EE /MW	0.197
HVAC Commercial	311.8	MWh/year in EE savings equals peak EE /MW	0.086
HVAC Residential	102.1	MWh/year in EE savings equals peak EE /MW	0.032
Residential Lighting	22.5	MWh/year in EE savings equals peak EE /MW	0.023

261

262

263

Table 6: 31W2 Energy Efficiency Conversion

Energy Efficiency	MWh	Annual Savings Worksheet	MW
Commercial Lighting	137.5	MWh/year in EE savings equals peak EE /MW	0.041
HVAC Commercial	59.5	MWh/year in EE savings equals peak EE /MW	0.016
HVAC Residential	115.3	MWh/year in EE savings equals peak EE /MW	0.037
Residential Lighting	23.1	MWh/year in EE savings equals peak EE /MW	0.024

264

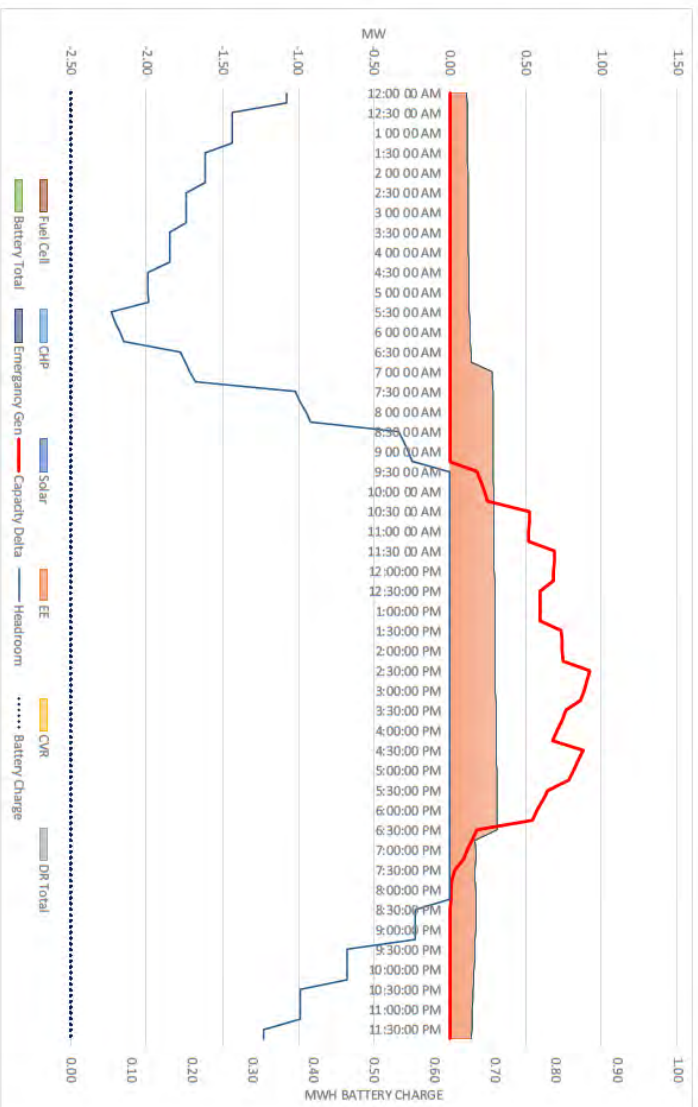

265

Figure 17: 31W1 2029 peak day with Energy Efficiency

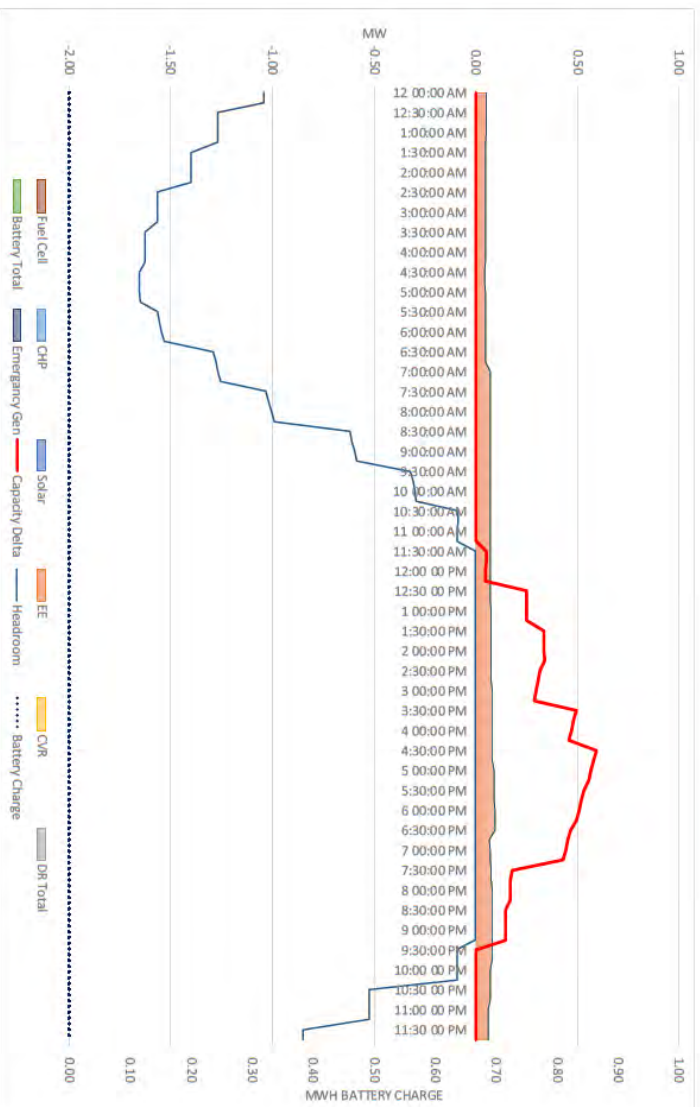

267

Figure 18: 31W2 2029 Peak Day with Energy Efficiency

268

269 DEMAND RESPONSE SCREENING

270 Eversource’s EE team also provided a potential estimation for Demand Re-
271 sponse (DR) solutions (See Table 4 and Appendix D). The main problem
272 with the DR solutions is their limited event horizon of 3 hours. The peak
273 load violations on 31W1 and 31W2, however, last 6+ hours, making them
274 unsuited for a DR approach. Even if the DR calls are staggered, they would
275 still end up producing situations where pre-conditioning and snap back
276 negatively impact the available capacity on the transformer. Figure 19
277 shows 31W1’s projected peak load day for 2030 with the assumed DR Po-
278 tential.

Note: All estimates of DR potential and might vary based on the willingness of customers to participate in the program. DR impact is dependent not only on time of year but also on time of day and might not yield the full anticipated effect.

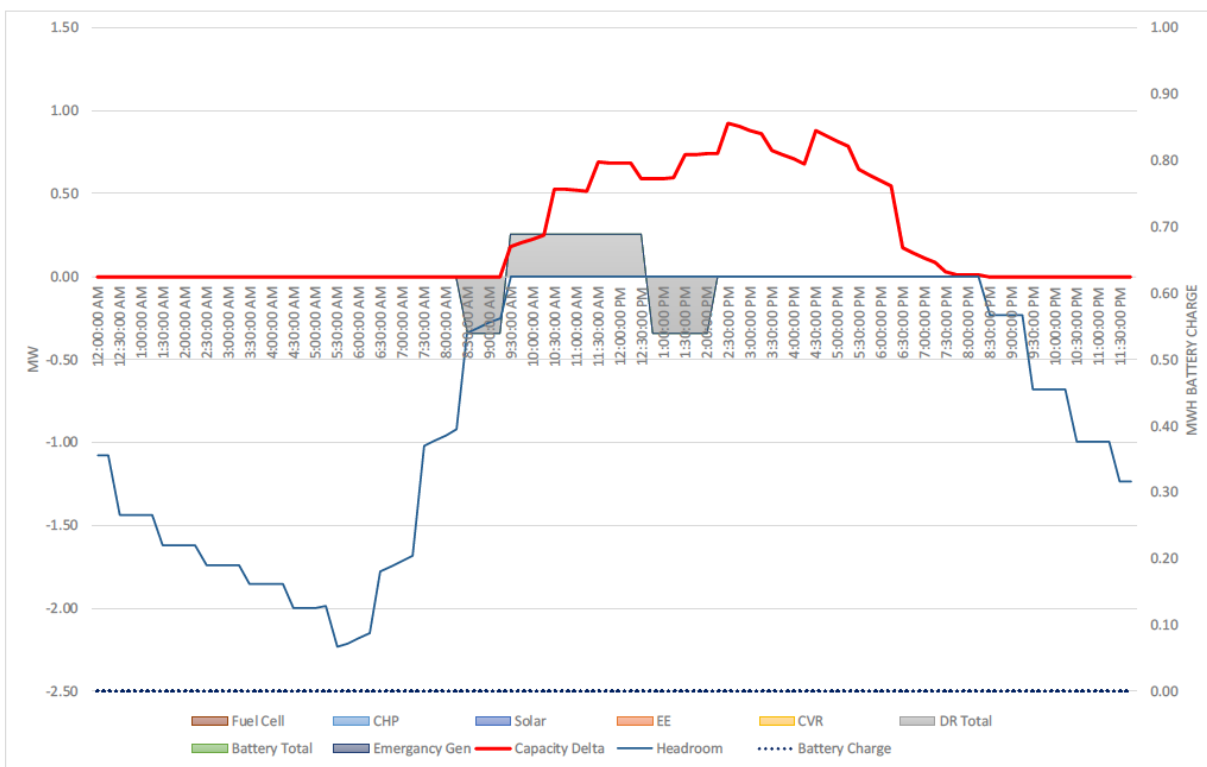

279

280 **Figure 19: Three-hour demand response event at 31W1 with preconditioning and snap back**

281 **In conclusion, based on the analysis, DR will not be considered a feasible solution for NWA application at Loudon.** The tech-
282 nical issues of accounting for the short event condition and the snap back and pre-conditioning reduce the validity of the ap-
283 proach. Furthermore, the very limited availability of DR compounded with the customer’s ability to opt out, (which is a very
284 real possibility given that the peaks coincide with race events), results in a very unreliable solution.

285

286 STORAGE SCREENING

287 For 31W1 and 31W2 a storage capacity analysis was conducted, yielding the required power rating and battery capacity to fully
 288 address the forecasted need at both stations. Table 7 shows the results of that analysis for 31W1, and Table 8 for 31W2

289

Table 7: Battery Capacity Requirements 31W1

Remaining Largest Capacity Delta	0.92	MW
Remaining Energy Delta	5.94	MWh
Required Battery Power	0.92	MW
Required Battery Capacity	6.44	MWh

290 Using a 1 MW/6.5 MWh BESS with the NWA Framework dispatch model, the
 291 following peak day dispatch is generated for 31W1 (see Figure 20). The as-
 292 sumption is that the battery system starts the peak day at 0% state of charge
 293 (SOC), charges up, and dispatches. This represents the worst-case starting
 294 point for a day. The dispatch model in Figure 20 shows that even when starting
 295 with an empty battery, the station provides for enough capacity to be fully charged before the first dispatch is needed.

Note: The battery capacity requirements are higher than the maximum delta to account for losses when discharging.

296 The BESS, much like the DR approach, has to contend with the very long system peak, resulting in a 6h+ battery system, which
 297 is a very atypical configuration. This makes the solution more expensive as the battery cells are by far the most expensive
 298 component.

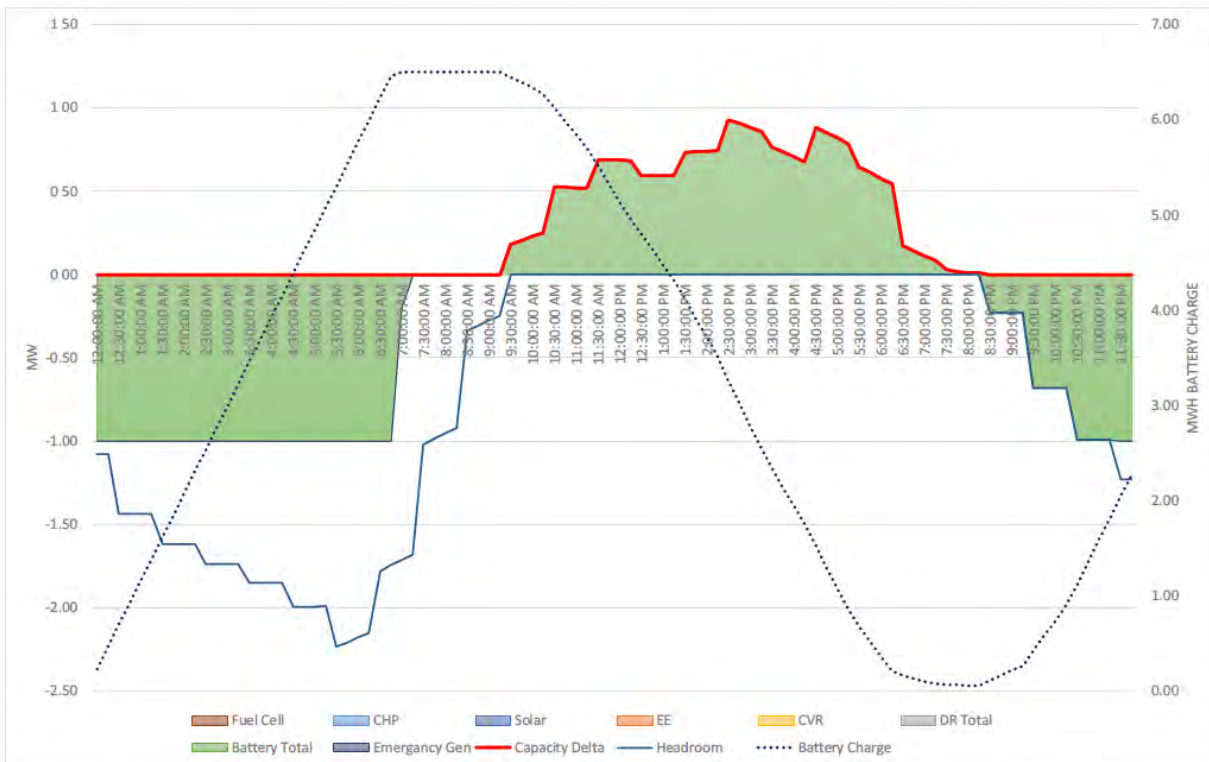

299

300

Figure 20: Battery Dispatch Model 31W1 during 2029 peak day

301 The same evaluation can be conducted for 31W2. Similar to 31W1 the result indicates that a 6h+ battery system is required.

302 **Table 8: Battery Capacity Requirements 31W2**

Remaining Largest Capacity Delta	0.59	MW
Remaining Energy Delta	3.26	MWh
Required Battery Power	0.59	MW
Required Battery Capacity	3.54	MWh

303 Also similar to 31W1, the BESS can start the day at an empty state and have enough time and transformer capacity to fully
304 charge itself before the first dispatch is required, as shown in the dispatch model for 31W2 in Figure 21 below.

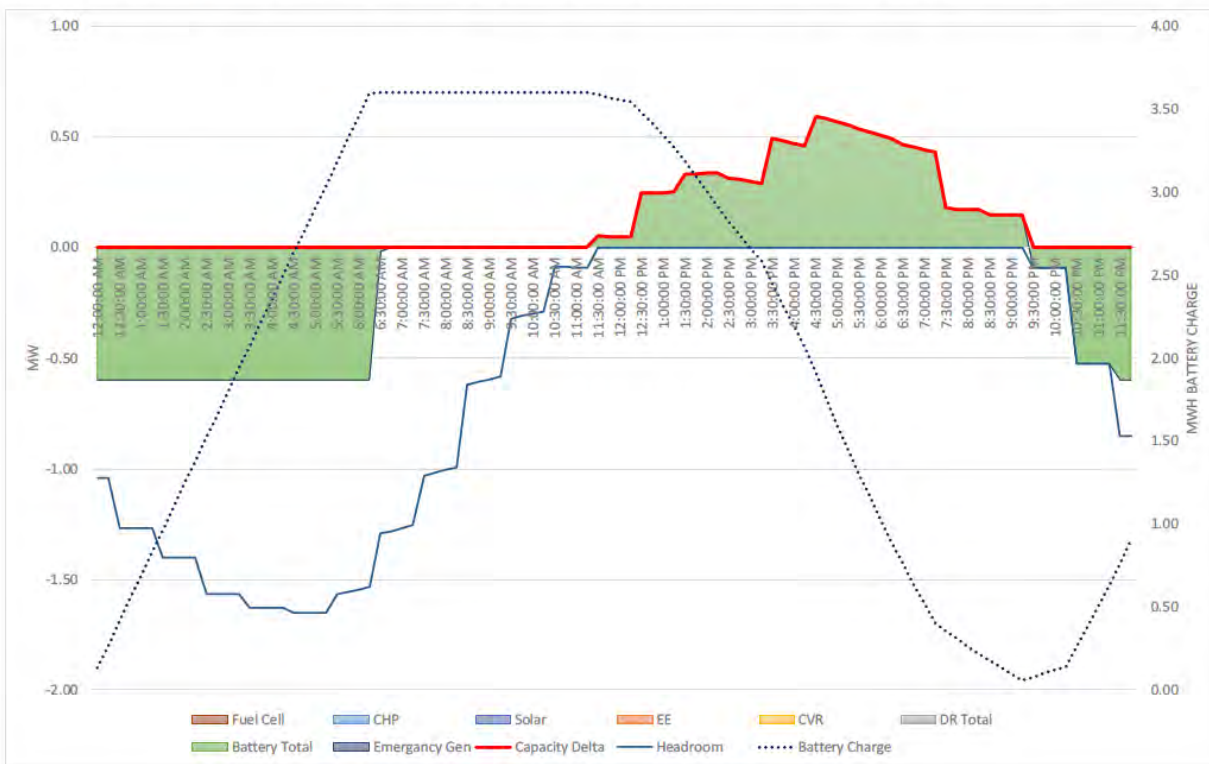

305
306 **Figure 21: Battery Dispatch Model 31W2 during 2029 peak day**

307 **In conclusion, battery energy storage solutions are capable of addressing**
308 **the transformer capacity violation.** While they require a configuration
309 that could be expensive for the 6h+ solution, this might be mitigated by
310 combining BESS with another solution, such as energy efficiency or solar
311 PV.

Note: Any battery solution must be conducted for both transformers, as they are not operated in parallel mode. As a result, a battery on 31W1 cannot reduce load on 31W2 and vice versa.

312

313 SOLAR PV

314 31W1 already has 0.68 MW of installed solar capacity. Its available hosting capacity considering the already installed PV capac-
 315 ity and the stations annual gross load profile is an additional 5.27 MW of installed AC power. This would total 5.95 MW of solar
 316 PV, reaching the maximum reverse power flow limit of 95% of 5.25 MVA during minimal loading conditions. In order to not
 317 introduce a new capacity violation on the transformer, this represents the
 318 maximum upper PV limit (not taking into consideration voltage rise, flicker or transient issues that might occur from such a large PV adoption which
 319 might reduce this value significantly). Under the assumption that this capacity would be deployed through several green field applications (4 @
 320 1 MW each) as well as rooftop solar by customers (1.27 @ 7 kW each), the
 321 following weather adjusted capacity profile is achieved in Figure 22.
 322
 323

Note: With the NWA Screening Tool's ability to run a year long time series of data, this automatically includes the determination of the minimum loading conditions on the system.

324 Due to the uncertainty around solar output based on weather conditions, the weather adjusted capacity profiles considered
 325 for Loudon and based on the NWA Framework are not sufficient to reliably offset the capacity need. They could possibly be
 326 made part of the solution mix, based on the load profiles peaking around noon to early afternoon hours.

327 In neither transformer's case is it possible to reliably resolve the capacity violation through solar installations alone. However,
 328 it should be noted that due to the shape of the peak, solar can impact the Loudon peak load significantly, which is generally
 329 not the case as most system peaks tend to occur in the late afternoon or early evening when solar is not at peak output.

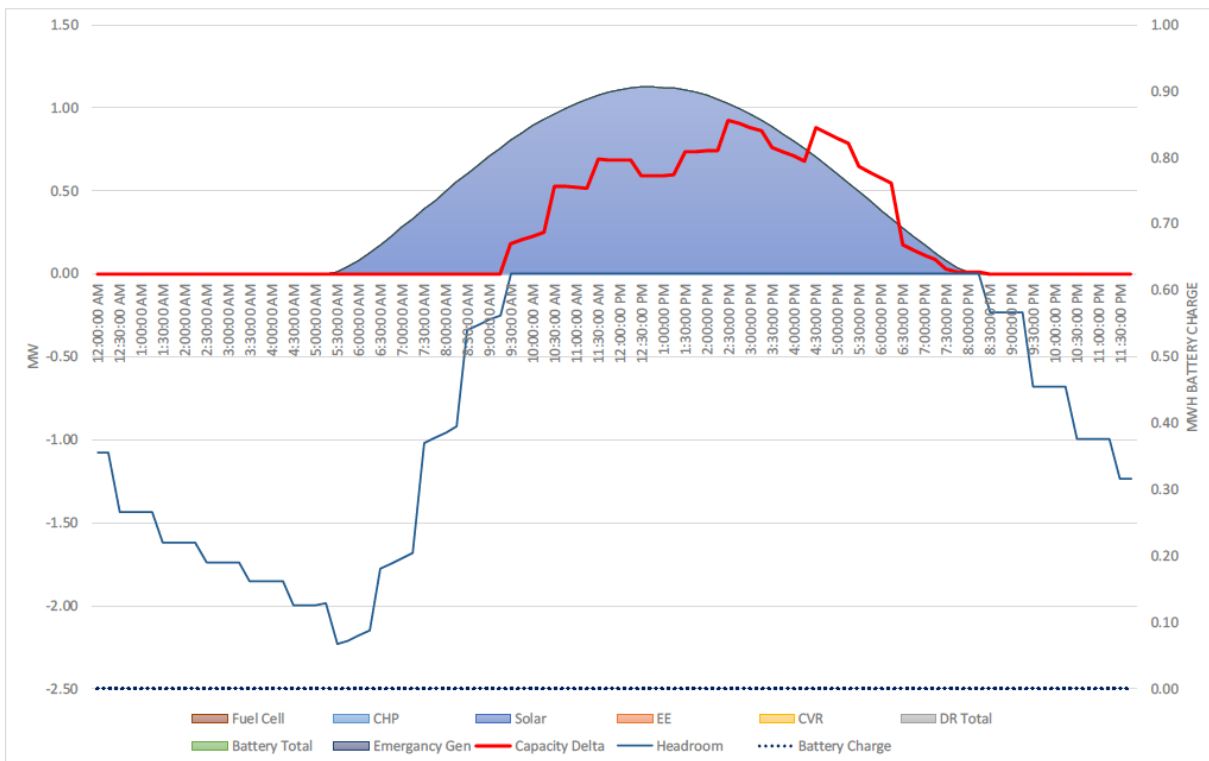

330

331

Figure 22: Weather Adjusted Solar Capacity Offsetting Capacity Need at 31W1

332 For 31W2 there are already 0.265 MW of solar PV with a remaining hosting capacity of 3.44 MW. Figure 23 shows the weather
 333 adjusted capacity profile using three 1 MW installations and 0.44 MW of BTM solar.

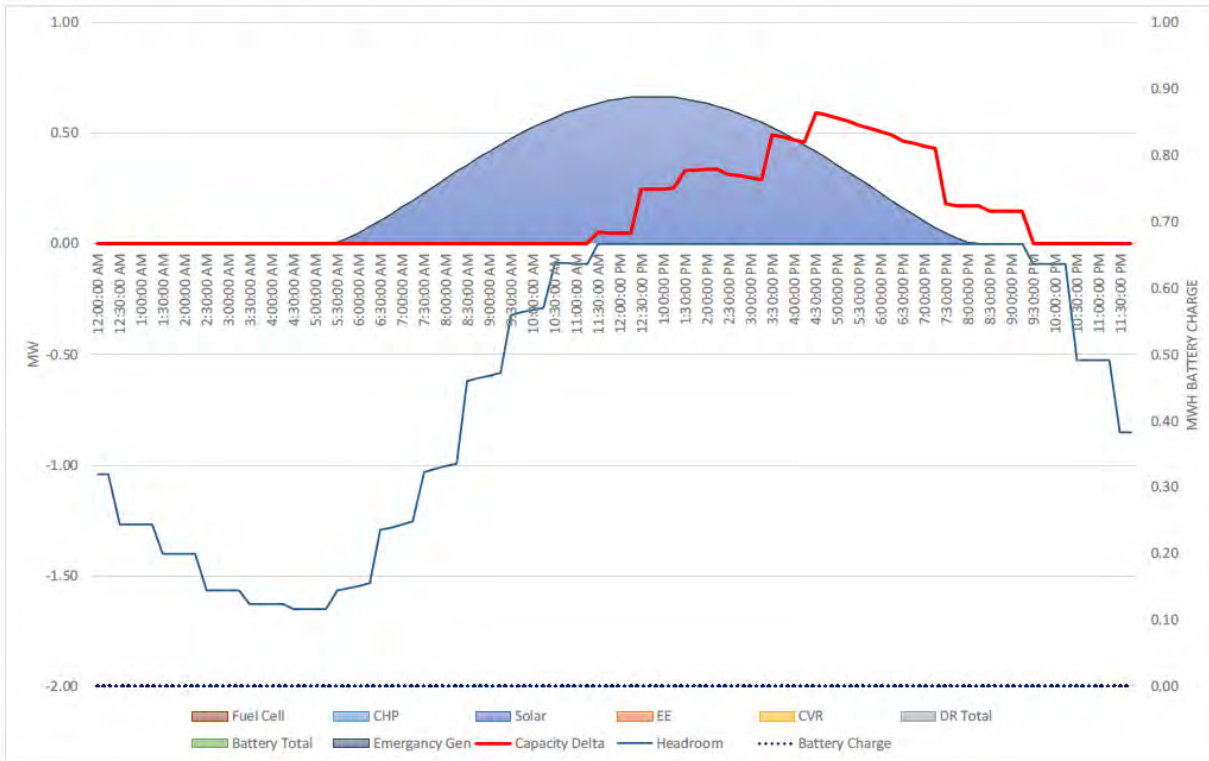

334

Figure 23: Weather Adjusted Solar Capacity Offsetting Capacity Need at 31W2

335

336 In conclusion, while solar PV provides a very good fit for 31W1, its fit on 31W2 is less ideal. In both cases, even when max-
 337 imizing the station's reverse power flow capacity, not all capacity needs can be reliably addressed. Considering solar pro-
 338 grams that help incentivize more solar adoption might prove to be a valuable part of an overall solution but cannot be a stand-
 339 alone approach.

340

341 COMBINED HEAT AND POWER

342 Deploying combined heat and power (CHP) would be, similar to mobile generation units, used as generators during the peak
343 hours of the year to dispatch, with the added benefit that those units could provide value in terms of load reduction and
344 thermal energy supply to customers. The focus here was exclusively on C&I customers.

345 a) **31W1**: 0.92 MW electric. With N-1 considerations, this equates to:

- 346 • 2 CHP units at 1 MW each
- 347 • 3 CHP units at 0.5 MW each
- 348 • 4 CHP units at 0.35 MW each
- 349 • Etc.

350 b) **31W2**: 0.59 MW electric. With N-1 considerations, this equates to:

- 351 • 2 CHP units at 0.6 MW each
- 352 • 3 CHP units at 0.3 MW each
- 353 • 4 CHP units at 0.2 MW each
- 354 • Etc.

Note: *CHP applications are larger investments requiring the participation of customers with enough annual electric and thermal load to make sense. Numbers in this report assume that those values can be reached, but a detailed analysis of the customers, siting visits, and evaluation of gas supply would further be required.*

355 For the purpose of the screening, it will be assumed that there is potential for three units at each transformer.

356 **In conclusion, CHP is a viable option that, depending on the duration of the deferral, could be a more cost-effective approach**
357 **than mobile generation as it does not have operating cost.** The assumption will be made that dispatch of the CHP assets
358 happens through Eversource's Enbala system to ensure availability when needed.

359

360 MOBILE GENERATION

361 Given the very limited number of event days, and the very predictable peak events based on the racetrack schedule, a mobile
362 generation unit can provide a very cost-effective solution. With a combined peak load of 0.92 + 0.59 MW, this falls well within
363 rental unit sizes. In addition, the few annual events minimize the greenhouse gas emissions and noise pollution from the solu-
364 tion. Figure 24 shows a generator dispatch with an 11-hour duration for 31W1 during its peak day 2029, providing sufficient
365 capacity relief for the entire event.

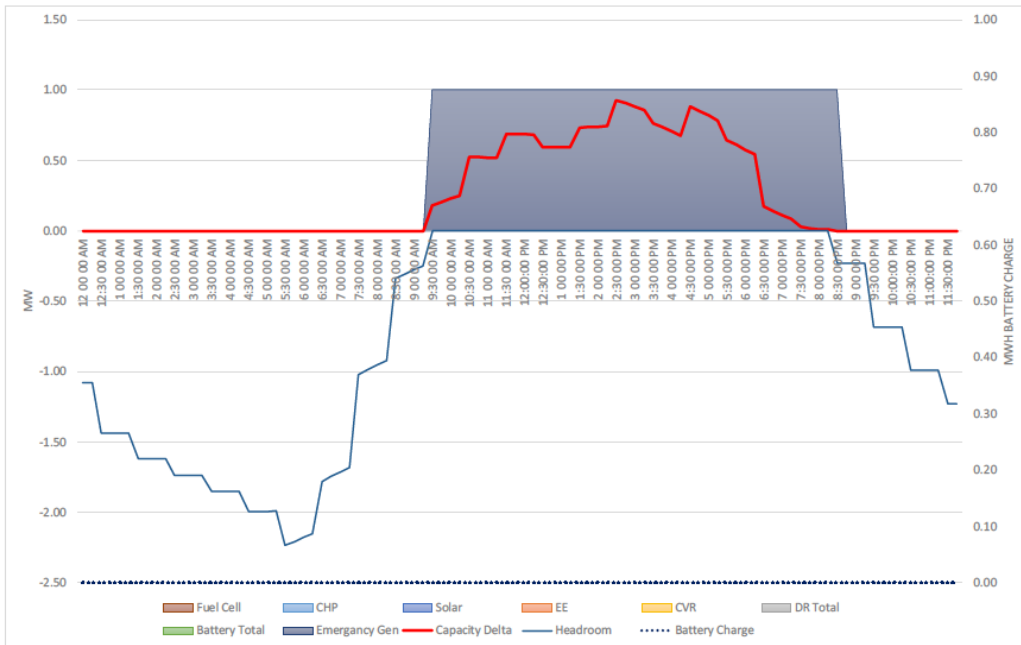

366

367

Figure 24: 31W1 2029 peak day dispatch model for mobile generation

368 In conclusion, mobile generation offers a very cost-effective approach to the capacity needs at Loudon Station. Especially
369 compelling is the fact that it works as a stand-alone technology NS can reliably address the entire capacity need.

370

371 **NWA SOLUTION PROPOSAL**

372 After introducing the relevant NWA technologies into the framework and toolset, the objective was to find a technology, or
373 group of technologies, that would be most cost effective at deferring the traditional upgrade. The following chapter will outline
374 an array of single and multi-solution approaches using NWA technologies for addressing the Loudon Station capacity need
375 through 2029. Each combination will be evaluated on its technical merits, as well as its benefit cost ratio in the next chapter.

376 **UTILITY SCALE STORAGE**

377 For a solution with utility scale storage alone, the parameters are as follows:

378 **Table 9: Battery Capacity Requirements 31W1**

Remaining Largest Capacity Delta	0.92	MW
Remaining Energy Delta	5.94	MWh
Required Battery Power	0.92	MW
Required Battery Capacity	6.44	MWh

379 **Table 10: Battery Capacity Requirements 31W2**

Remaining Largest Capacity Delta	0.59	MW
Remaining Energy Delta	3.26	MWh
Required Battery Power	0.59	MW
Required Battery Capacity	3.54	MWh

380 The net present value (NPV) of the cumulative revenue requirement of such a solution is **\$9,166,961**, based on the following
381 inputs:

- 382 a. Commissioning of the battery in 2025
- 383 b. Financial Planning Horizon of 15 years
- 384 c. Operated as a Load Reducer (charging and discharging at retail rate)

Note: *The two storage solutions cannot be combined as the transformers are not operated in parallel.*

386 **ENERGY EFFICIENCY AND UTILITY SCALE STORAGE**

387 If a full energy efficiency program is deployed on both 31W1 and 31W2, the requirements for the storage size can be signifi-
388 cantly reduced. 31W1, particularly, due to its high commercial energy efficiency potential shows a reduction in power by about
389 30% and capacity by more than 45% (Table 11)

390 **Table 11: Battery Capacity Requirements 31W1 at 2029 Peak Day with Energy Efficiency**

Remaining Largest Capacity Delta	0.63	MW
Remaining Energy Delta	3.19	MWh
Required Battery Power	0.63	MW
Required Battery Capacity	3.46	MWh

391 For 31W2, the reduction in power and capacity requirements are less prominent with more than 19% and 20% respectively.

392

Table 12: Battery Capacity Requirements 31W2 at 2029 Peak Day with Energy Efficiency

Remaining Largest Capacity Delta	0.51	MW
Remaining Energy Delta	2.50	MWh
Required Battery Power	0.51	MW
Required Battery Capacity	2.71	MWh

393 The cost of deploying the energy efficiency programs is assumed to be incurred at 33% in years 2023, 2024 and 2025. As a
394 result, the NPV of the cumulative revenue requirement for the energy efficiency program is **\$625,407**, using typical Eversource
395 cost parameters to develop such a solution.

396 The remaining battery solutions now present an NPV cumulative revenue requirement of **\$6,349,867**. The introduction of en-
397 ergy efficiency to offset storage capacity has provided a **24% reduction** in the overall solution cost, from **\$9,166,961** to
398 **\$6,975,274**.

399 ENERGY EFFICIENCY AND BEHIND THE METER STORAGE PROGRAM

400 A standalone behind the meter battery storage approach is unlikely to succeed due to the capacity requirements of the battery
401 systems. While it would possible to aggregate sufficient installed battery power, the requirements for 6h+ batteries are far
402 outside the typical scope of a behind the meter battery system (2 hours). When combined with Energy Efficiency, this can be
403 made to work under the premise that the behind the meter battery systems are fully dispatchable by the utility and provide a
404 3-hour rating. Figure 25 shows 31W1 with a fully exercised EE program in addition to 1.25 MW BTM storage installation with a
405 total availability of 3.75 MWh (3-hours).

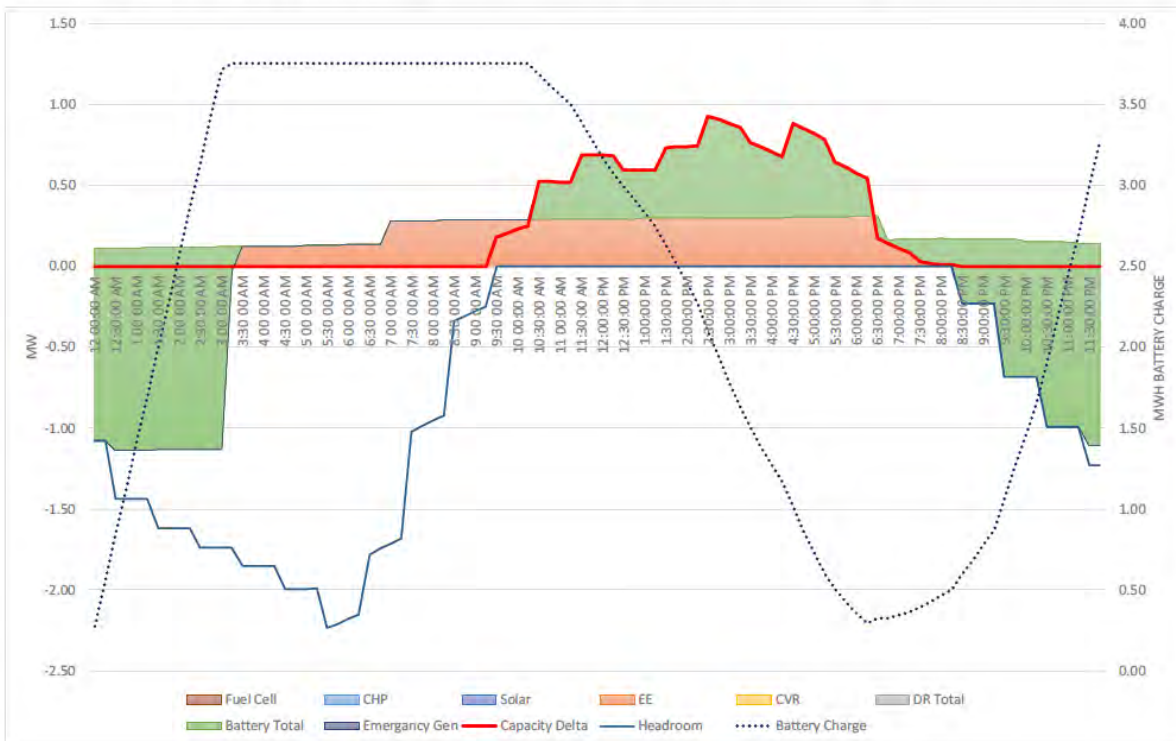

406

407

Figure 25: 31W1 peak day 2019 with full EE and BTM Storage Program

408 The same is applicable to 31W2. The minimum yield for each station on the BTM Battery Program would be

- 409 a. **31W1:** The minimum yield for the battery program is 0.63 MW
410 and 3.46 MWh, yielding
411 o 1.2 MW @ 3-hour battery set up
412 o 1.0 MW @ 4-hour battery set up
413 b. **31W2:** The minimum yield for the battery program is 0.51 MW
414 and 2.71 MWh, yielding
415 o 1.0 MW @ 3-hour battery set up
416 o 0.7 MW @ 4-hour battery set up

Note: *The limiting factor on the behind the meter battery solution is the estimated potential in the region. With about 1.25 MW, a two-hour battery would yield only 2.5 MWh, while almost 3.5 MWh and 2.71 MWh are needed.*

417

Note: *The Battery Dispatch Model considers the options of partial and staggered dispatch through a DERMS solution allowing the stitching together of a dispatch profile from multiple shorter batteries. All dispatches shown include this assumption.*

In both cases, a 2-hour battery solution for behind the meter applications would exceed the estimated potential in the region in terms of installed capacity. 3-hour battery solutions are not standard for behind the meter applications and pose a risk to the program.

Using the 3-hour model, the cost of a 5-year behind the meter battery program (standard contract length) would come in at NPV cumulative revenue requirement of **\$2,200,651**. In addition to the cost of the energy efficiency program, this yields a total solution cost of **\$2,826,058**.

425 ENERGY EFFICIENCY, SOLAR, AND BEHIND THE METER STORAGE

426 By adding a specialized program to incentivize behind or in-front of the meter, customer owned,
427 solar generation, the energy gap required to enable a 2-hour storage program can be bridged.

428 The minimum installed additional solar capacity for each transformer in power (AC) assuming a
429 120% DC overlocking is:

- 430 a. **31W1:** 0.7 MW of BTM solar generation
431 b. **31W2:** 0.2 MW of BTM solar generation

432 Figure 26 shows the dispatch model for the behind the meter storage program assuming
433 1.25 MW 2-hour systems with the addition of 0.7 MW behind the meter solar.

434 With a proposed compensation of \$35/MWh, the overall program to achieve these solar values
435 would have an NPV cumulative revenue requirement of **\$176,199**. However, since the storage
436 programs are designed around the available MW, and not the MWh, the cost of the storage
437 program would not change, bringing the total solution NPV cumulative revenue requirement to
438 **\$3,002,257**.

439 Figure 26 shows the dispatch model on 31W1 during the 2029 peak day event with the impacts
440 of energy efficiency, solar, as well as the dispatch of the BTM batteries.

Note: *If approached through a solar program, Eversource would incentivize solar generation by compensating additional cent/kWh value for all newly built generation assets. To ensure availability, assets receiving this additional compensation would be required to sign into a contract which puts penalties on non-performance due to negligence. Contracts would be for 5 years, similar to other Eversource programs.*

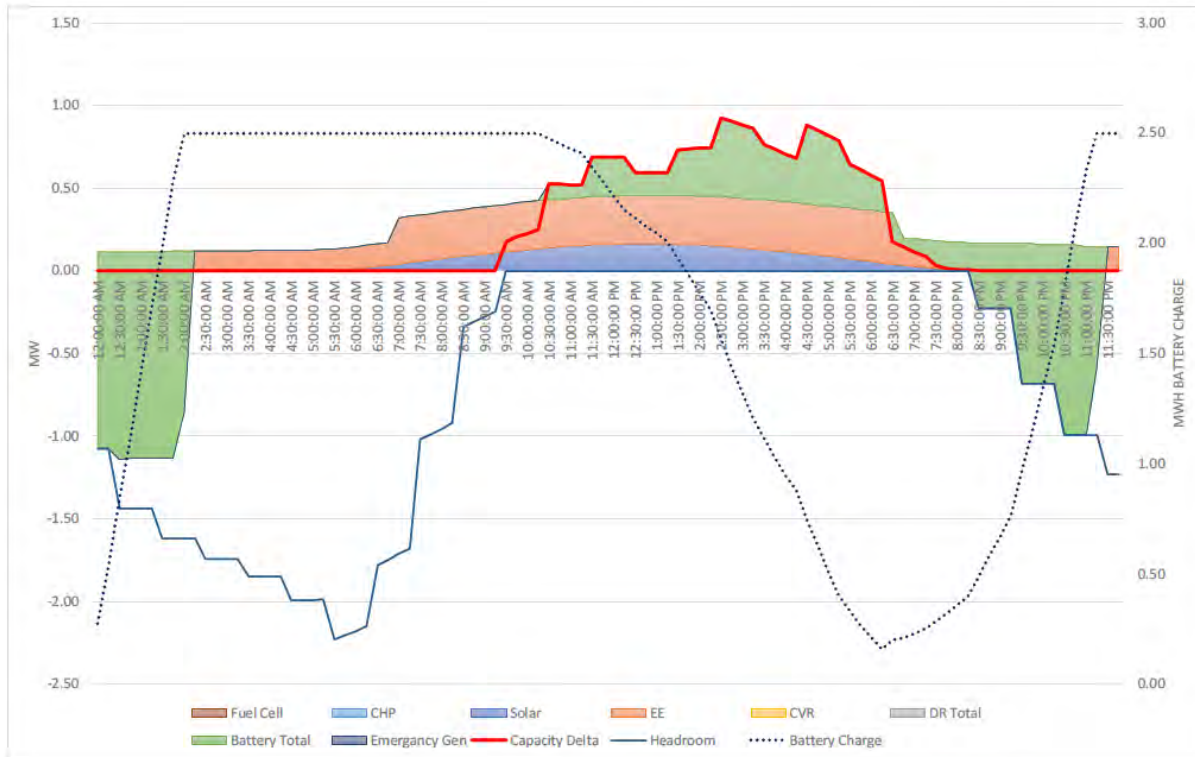

441

442

Figure 26: 31W1 2029 Peak Day with Energy Efficiency, 0.7 MW of Solar, and 1.25 MW of 2-hour BTM Storage

443 ENERGY EFFICIENCY AND SOLAR PV

444 By fully utilizing the Energy Efficiency potential in the region, 31W1’s capacity deficit can be addressed through solar installa-
445 tions that are within the station’s hosting capacity limit. At 31W2 this approach does not
446 work.

- 447 a. **31W1:** In addition to a fully deployed energy efficiency program, four 1 MW solar
448 installations, as well as 0.8 MW behind the meter solar programs would address the
449 capacity deficit
- 450 b. **31W2:** Due to the later in the evening peak events, 31W2 cannot be addressed
451 within hosting capacity limits, even with energy efficiency added

452 The following Figure 27 shows the weather adjusted solar dispatch model as well as the en-
453 ergy efficiency impact, assuming maximum utilization of the energy efficiency potential for
454 31W1.

455 The capacity need at 31W2 cannot be addressed solely with energy efficiency and solar. As a
456 result, assuming a maximum roll out of the solar program, mobile generation resources
457 would have to be made available. Figure 28 shows the dispatch model for all three NWA
458 assets during the 2019 peak day scenario. The generator is needed for a total of 4 hours.

459

Note: Due to reliability re-
quirements and N-1 calcula-
tions, utility scale and BTM
solar are treated differently.
Utility scale solar falls under
an N-1 rule, with the largest
asset removed from the ca-
pacity calculation, while the
BTM solar program achieves
a reliability factor of 95%. It
is therefore beneficial to
have more smaller utility
scale systems as opposed to
one large unit.

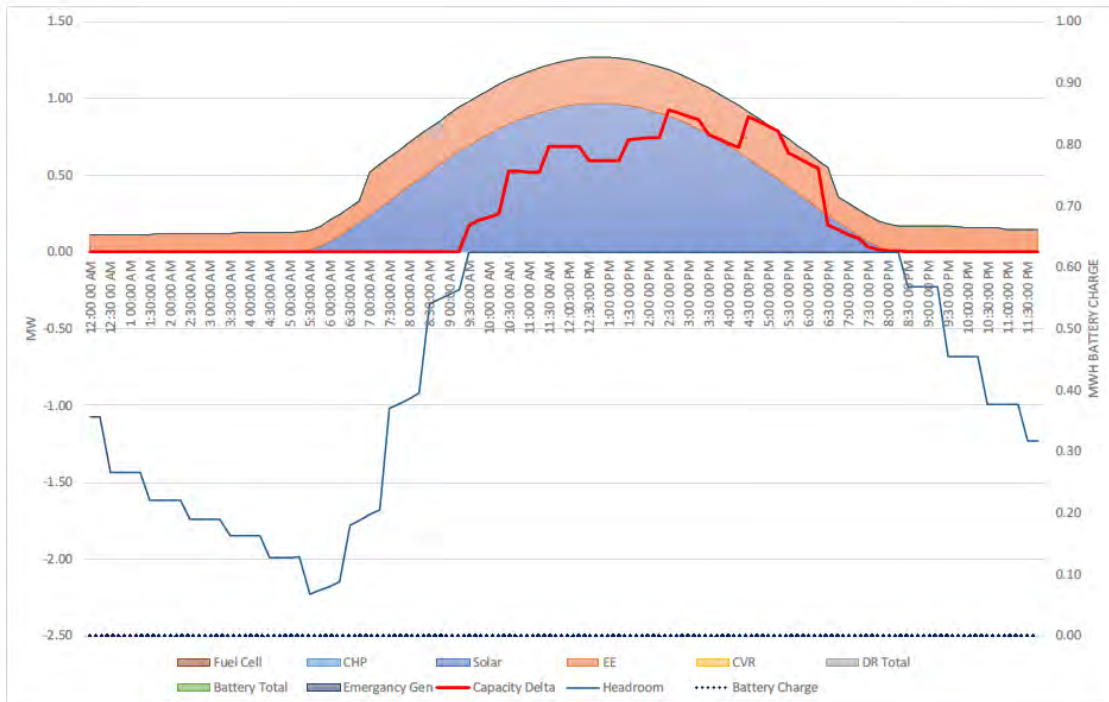

460

461

Figure 27: 31W1 Peak Day at 2029 with Solar and Energy Efficiency Dispatch Model

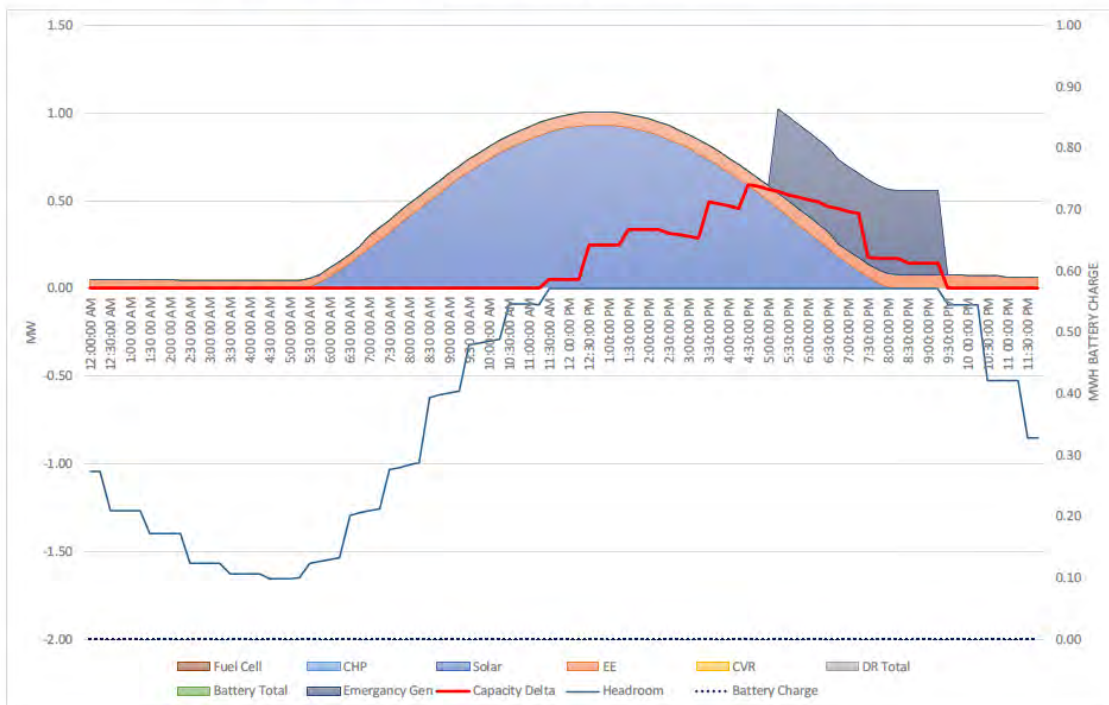

462

463

Figure 28: 31W2 at 2019 Peak Day with Mobile Generation Backing up Solar and EE Dispatch

464 The NPV of the cumulative revenue requirement of the various solution components are shown below:

- 465 a. EE for 31W1 and 31W2 is **\$625,407**
- 466 b. The solar program for 31W1 and 31W2 is **\$1,738,818**
- 467 c. The mobile generation unit for 31W2 is **\$501,708** (includes backup capability under N-1 requirements)

468 The NPV of the resulting overall solution cost of **\$2,865,933** in NPV

469 **CONVENTIONAL GENERATION ONLY**

470 Using a generator only set up, the following requirements need to be met

- 471 a. **31W1**: 1 MW for 3 days a year and 11 hours a day
- 472 b. **31W2**: 0.64 MW for 6 days a year and 10 hours a day

473 In addition, to comply with the N-1 planning requirements, a third generation unit of 1 MW needs to be placed on standby for
474 the duration of the longer deployment (6 days). The total NPV of the cumulative revenue requirement for this solution is
475 **\$1,020,875**. Beneficial to this solution is the fact that after deferral timeframe is over, it can be simply discontinued resulting
476 in absolute cost control, even if the forecast should prove to be wrong. Furthermore, should external circumstances force an
477 earlier upgrade of the station, e.g. due to technical failure of a transformer, the mobile generators would be discontinued
478 exposing the least amount of risk.

479 **ENERGY EFFICIENCY AND CONVENTIONAL GENERATION**

480 Deploying the full energy efficiency measures would reduce the required
481 generation capacity and the associated greenhouse gas emissions, with
482 new requirements being

- 483 c. **31W1**: 0.64 MW for 3 days a year and 8 hours a day
- 484 d. **31W2**: 0.64 MW for 6 days a year and 10 hours a day

485 The NPV of the cumulative revenue requirement for this solution comes
486 in at **\$1,371,127**

Note: For 31W2, there is no reduction in generator size, as the next smaller type of generator at 0.48MW is insufficient to match the requirements. N-1 considerations are still applied and a third 0.64 MW generation is kept on standby.

487 **COMBINED HEAT AND POWER**

488 To achieve reliable compensation of the capacity delta, the assumed sce-
489 nario will be that for both transformers, three CHP plants can be set up, in
490 order to provide the required

- 491 a. **31W1**: 0.92 MW electric with 3 CHP units averaging 0.5 MW elec-
492 tric
- 493 b. **31W2**: 0.59 MW electric with 3 CHP units averaging 0.3 MW elec-
494 tric

495 The total program cost as NPV of the cumulative revenue requirement of
496 that solution is **\$2,169,327**.

Note: Typical programs from Eversource provide for an incentive of ~\$1000/kW of installed electric power. All benefits remain with the customer. Eversource's CHP programs allow for an active dispatch through our Enbala Platform, which would be utilized in this scenario to ensure dispatch during the peak event days.

497

498 COMBINED HEAT AND POWER AND ENERGY EFFICIENCY

499 To increase the chance of success with the CHP approach, deployment of energy efficiency can help minimize the total required
500 generation capacity.

501 With the deployment of the full energy efficiency program, the requirements for the CHP capacity shrinks to

502 a. **31W1**: 0.63 MW electric with 3 CHP units averaging 0.35 MW electric

503 b. **31W2**: 0.51 MW electric with 3 CHP units averaging 0.26 MW electric

504 The total program cost as NPV of the cumulative revenue requirement of that solution is **\$2,244,867**.

505 COMBINED HEAT AND POWER, ENERGY EFFICIENCY, AND MOBILE GENERATION

506 By introducing a single mobile generator to the mix, the N-1 criteria for the CHP units is lifted. With the mobile generator being
507 rented and put on standby in case a CHP resource on either one of the transformers does not perform, only minimal rental
508 costs are incurred.

509 a. **31W1**: 0.63 MW electric with 2 CHP units averaging 0.35 MW electric

510 b. **31W2**: 0.51 MW electric with 2 CHP units averaging 0.26 MW electric

511 One mobile generation unit will be rented out to provide the N-1 consideration for the CHP assets to be onsite, should one of
512 the four (4) assets not perform. This allows the reduction of the total CHP capacity by 0.61MW.

513 The total solution cost as NPV of the cumulative revenue requirement of that solution is **\$1,903,086**.

514

515 **BENEFIT COST ANALYSIS**

516 The benefit cost analysis of the NWA solutions is based on the value of deferring the system upgrade at Loudon Station. With
517 the original capital expense planned for 2025 and the planning horizon ending 2029, a deferral of at most 5 years (until 2030)
518 can be achieved. Due to the marginal increase in forecasted load over the 10-year forecast horizon, a deferral of the asset for
519 less than the full 5 years makes little sense, as it reduces the value significantly while only gaining marginally less requirements.
520 At this point, no forecasts for load development can be made, nor would any forecasts be accurate enough to base larger
521 financial decisions on. Furthermore, 31W2 already has a station health metric of 0.46 which is close to the point of replacement
522 and should be re-evaluated in the next 10 years. The cost of the traditional station upgrade is based on Eversource’s experience
523 with the rebuild of Twombly Street Substation. The cost is estimated to be **\$6,500,000**.

524 A deferral of that cost by 5 years creates a cumulative net present value benefit of **\$1,657,187**. Any NWA solution will have to
525 be able to resolve the capacity constraint with a lower NPV cumulative revenue requirement.

526 The benefit cost ratio (BCR) is calculated as

527
$$\frac{\text{cumulative net present value of deferral}}{\text{cumulative revenue requirement net present value of NWA solution}}$$

528 The BCR needs to be greater than one (1) to ensure that the NWA solution costs the customer less than the value of the deferral.
529 Figure 29 shows the respective benefit to cost ratios of the solution proposals discussed earlier.

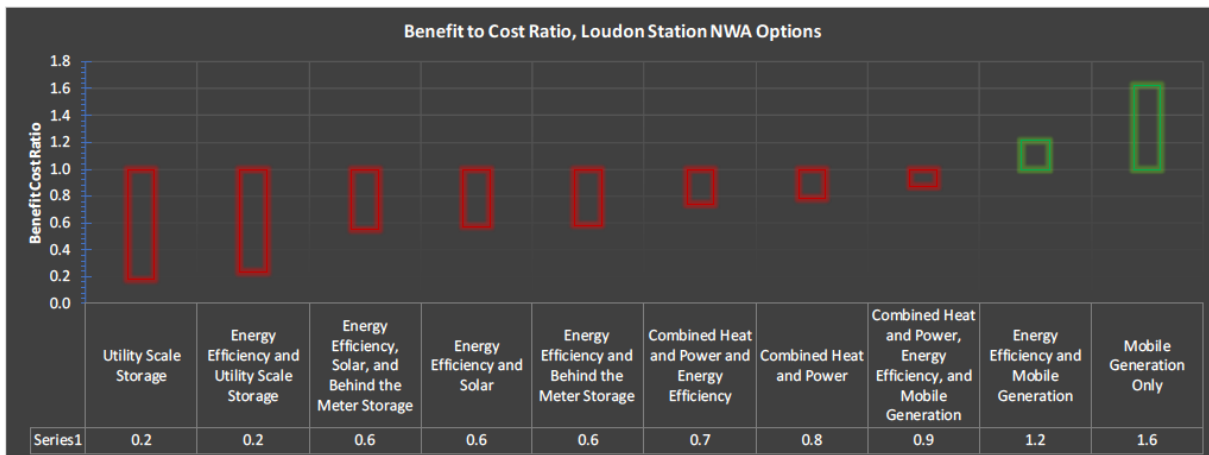

530

531 **Figure 29: Benefit to Cost Ratio of Loudon Station NWA Options**

532 **Due to the relatively cost-effective traditional solution, the shape and requirements of the capacity need, and the critical**
533 **asset health index of 31W2, the most cost-effective NWA solution for Loudon Station is mobile generation deployment at**
534 **peak load times. In addition, the flexibility of annual rentals of the units provides the single most adaptable solution to**
535 **changes in the Loudon Station load.**

536 Further supporting this conclusion is the fact that the 31W2 transformer ranks at 0.46 on Eversource’s new asset health index
537 which identifies assets with a high (1) rate of failure, compared to not at-risk assets (0). Eversource considers assets at >0.5 at

538 a high risk of failure. A health index greater than 0.5 equals a turn insulation drop below 400. (new transformers are at ~1000).
539 Industry/literature⁷ accepted practice is that <400 is a replacement candidate.

540 This is supported by the fact that several of the dissolved gases found in 31W2's oil are at high or elevated levels. Most recently,
541 evidence of thermal stressing of the paper insulation is showing. There is also a history of electrical faults within the main tank.
542 Analysis of the oil indicates that 31W2 is an unhealthy transformer due to the following factors.

- 543 • The main tank dissolved gas analysis has a history of thermal related faults to paper insulation and electrical faults
- 544 • The main tank furans test reveals the degree of polymerization is very low with a high amount of 2-furfural

545 In addition to the indications of aging, transformer bushings X2 will require replacement. As such, the mobile generation solu-
546 tion has the added benefit of being highly flexible as Eversource continuous to closely monitor the health of 31W2. By enabling
547 the company, at a moments notice, to implement the traditional solution upgrade without stranding significant capital in more
548 permanent NWA solutions, **the mobile generation proves to not only be the most cost-effective deferral, but also the least**
549 **risky if an NWA solution is suitable.**

550

⁷ EPRI 3002019254 Analysis Assessment and Comparison

551 APPENDIX

552 A

553 The following plots show results on overclocking of DC/AC ratios in CT which was used as a baseline assumption for converting
 554 the irradiance profiles to historic load output.

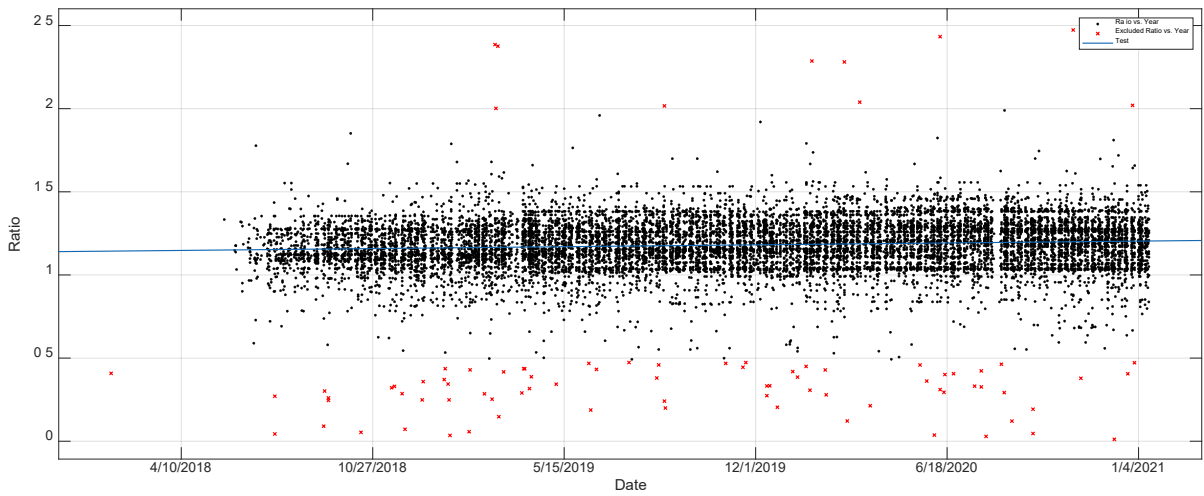

555

556

Figure 30: CT Analysis – Overclocking over Time

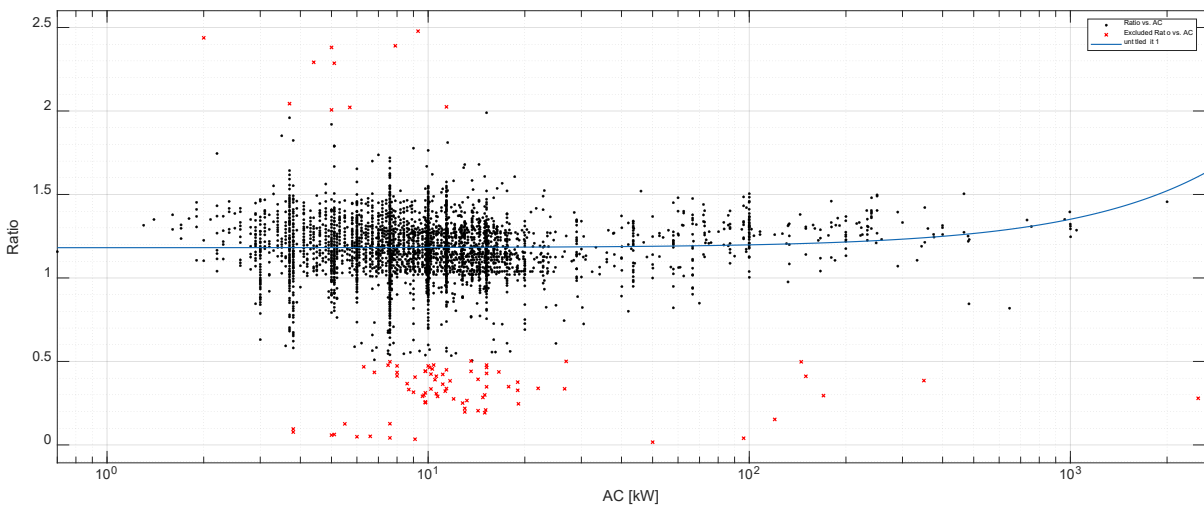

557

558

559

Figure 31: CT Analysis – Overclocking over AC Installed

560 **Development of overclocking over time**

561 ▪ Coefficients (with 95% confidence bounds):

562 – $p_1 = 0.0205/\text{year}$ (0.0173/year, 0.0237/year)

563 ▪ 2021 expected average overclocking across all system sizes: 1.208

564 **Development of overclocking depending on the AC installed size**

565 ▪ Coefficients (with 95% confidence bounds):

566 – $p_1 = 0.0001705/\text{kW}$ (0.0001103, 0.0002308)

567 – $p_2 = 1.181$ (1.178, 1.183)

568 ▪ 500 kW System: 1.266

569 ▪ 2000 kW System: 1.522

570

571 B

572 In a study conducted by Eversource on the likelihood of reduced solar output during peak conditions it was consistently deter-
 573 mined that while intuitive assumptions suggest that high load days correlate with a sunny weather, such is not always the case.
 574 For system planning purposes, such considerations have to be made to allow for hot, humid, and cloudy days as they would
 575 then overload the station capacity.

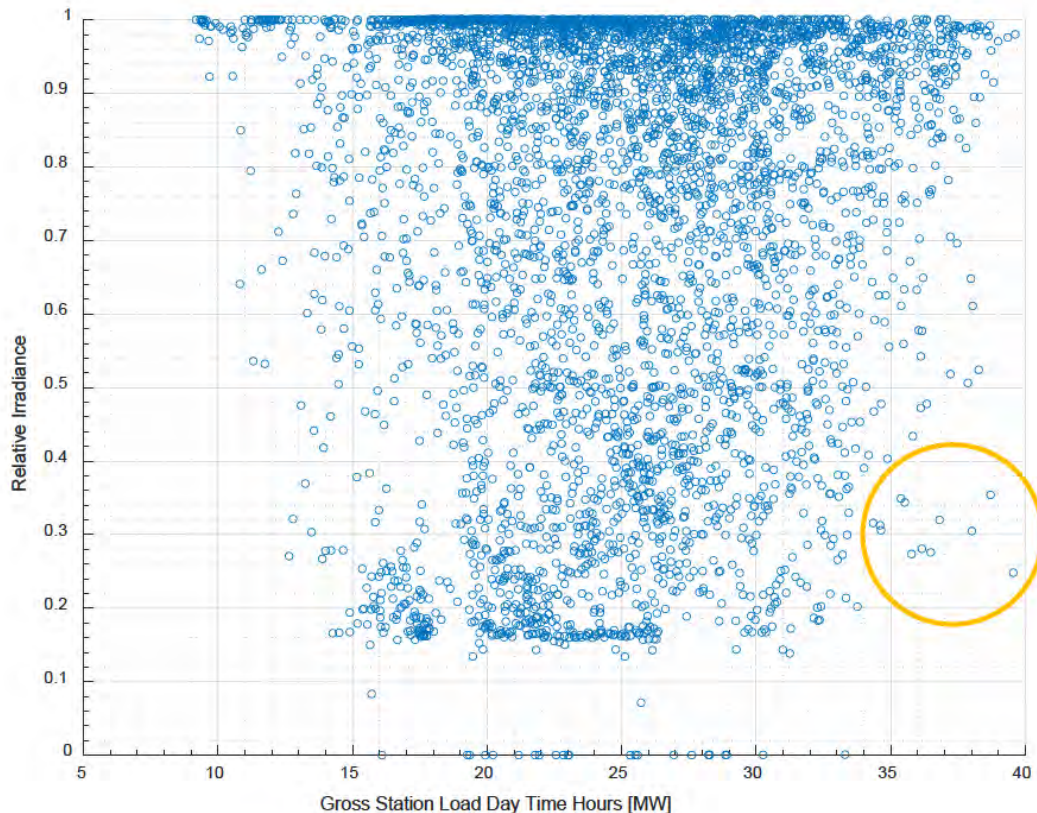

576

577 **Figure 32: Sample Station Relative Irradiance Profile over Station Load**

578 Using a broad sample size of Western Massachusetts stations, the company analyzed the historic relative irradiance and proved
 579 that there is no firm load/relative irradiance correlation. Figure 33 shows the relative irradiance probability distribution during
 580 summer month for the stations analyzed in Western Massachusetts.

581 **NOTE:** The relative irradiance is the quotient of actual over clear sky output. As such, it can be 100% at any point of day.

582

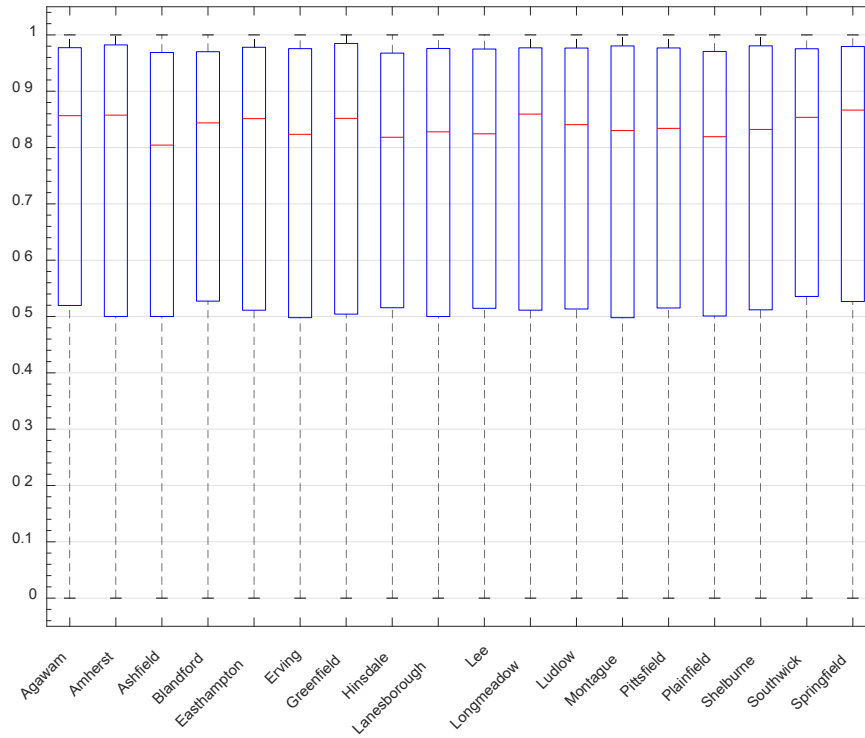

583
 584

Figure 33: Probability of Relative Irradiance on Western Massachusetts Bulk Stations

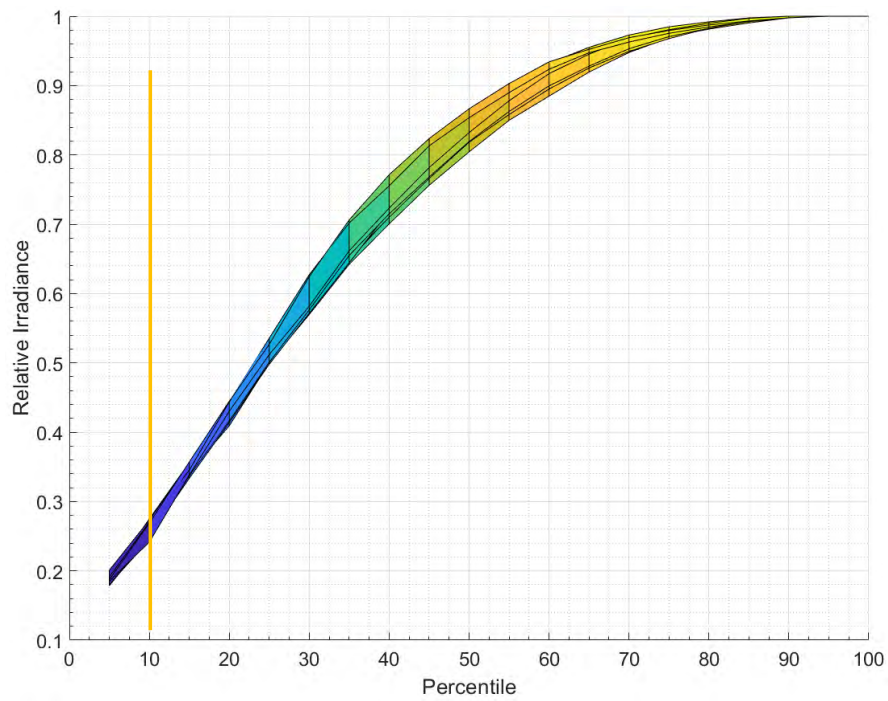

585
 586

Figure 34: 10th Percentile Relative Irradiance

587

C

588

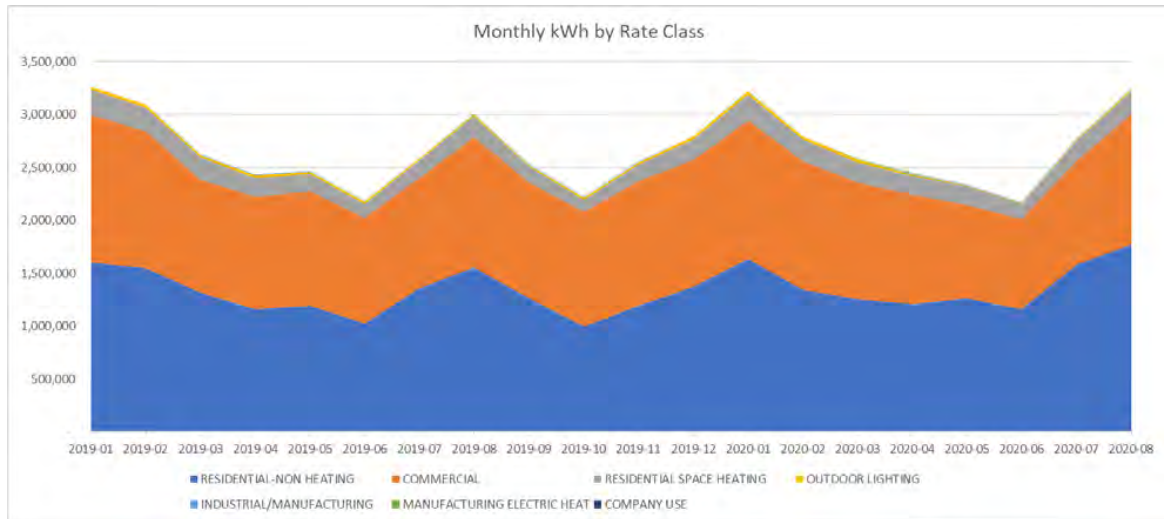

Revenue Class Code	Annual kWh (2019)	Peak Summer kWh	% of S/S Usage (KWH)	% of Annual (2019)	% of Peak Summer Usage
COMMERCIAL	13,712,465	1,232,198	41.9%	43.2%	41.1%
COMPANY USE	3,730	366	0.0%	0.0%	0.0%
INDUSTRIAL/MANUFACTURING	35,765	2,637	0.1%	0.2%	0.1%
MANUFACTURING ELECTRIC HEAT	22,478	1,695	0.1%	0.1%	0.1%
OUTDOOR LIGHTING	239,020	10,400	0.7%	1.3%	0.6%
RESIDENTIAL SPACE HEATING	2,157,548	200,901	7.0%	12.2%	11.5%
RESIDENTIAL-NON HEATING	15,580,465	1,553,146	50.3%	100.0%	100.0%

589

590

Figure 35: Monthly kWh consumption by rate class at Loudon Station

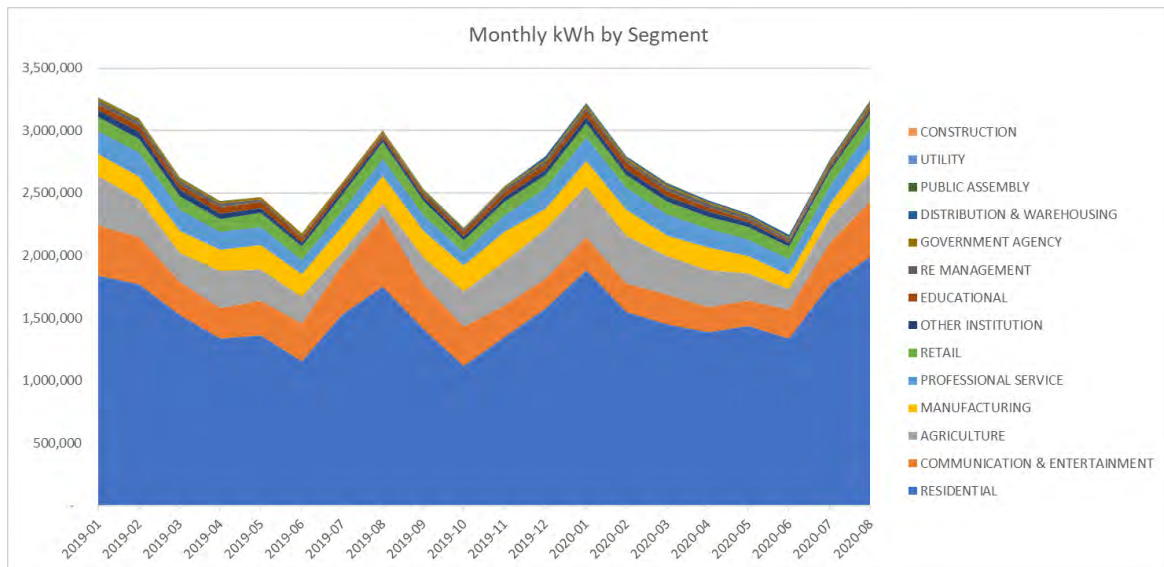

591

592

Figure 36: Monthly kWh usage by segment at Loudon Station

593 D

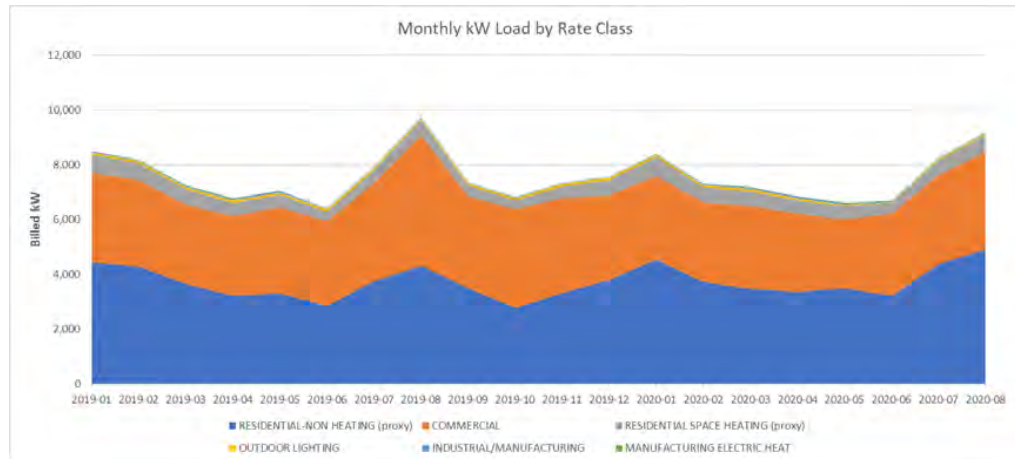

Rate Class	Customers	Annual kW (2019)	Peak Summer (kW)	% of S/S kW	% of Annual kW	% of Peak Summer (kW)
RESIDENTIAL-NON HEATING (proxy)	2,322	43,279.1	4,314.3	49.1%	47.6%	44.3%
COMMERCIAL	177	40,289.5	4,775.5	42.5%	44.3%	49.1%
RESIDENTIAL SPACE HEATING (proxy)	309	5,993.2	558.1	6.8%	6.6%	5.7%
OUTDOOR LIGHTING	1	853.3	38.6	0.9%	0.9%	0.4%
INDUSTRIAL/MANUFACTURING	5	445.8	31.8	0.5%	0.5%	0.3%
MANUFACTURING ELECTRIC HEAT	1	145.8	10.9	0.2%	0.2%	0.1%

594

595 Figure 37: Monthly kW Load by Rate Class

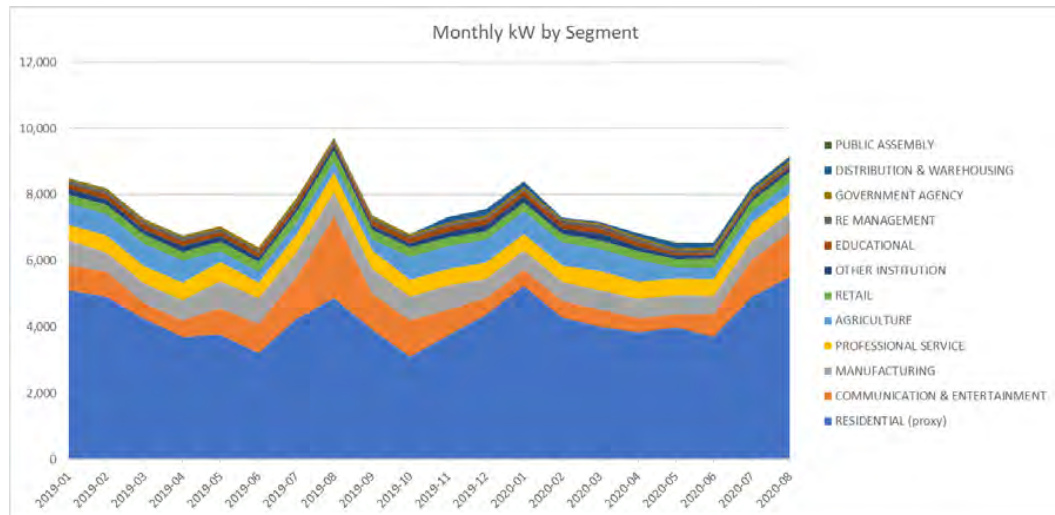

- Residential Segment represents 56% of Total Substation kW. Patterns indicate seasonal weather dependence
- Communication & Entertainment, Agriculture represent an additional 20% of Total kW

596

597

Figure 38: Monthly kW by Segment

598 E

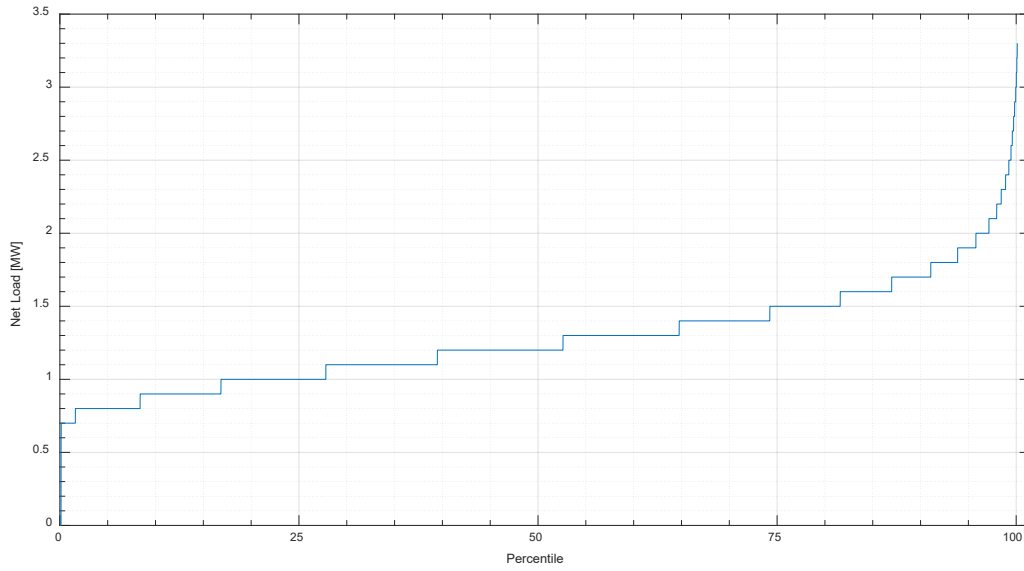

599

600

Figure 39: 2019 Load Percentiles Net Load Data at 31W2

601

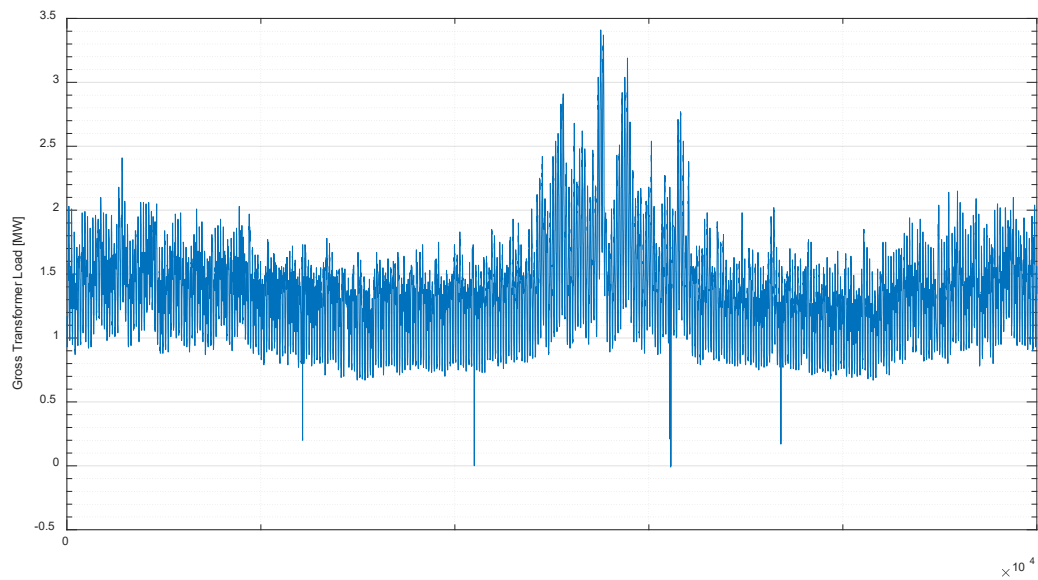

602

603

Figure 40: 2019 Time Series Gross Load Data at 31W2 Loudon Station

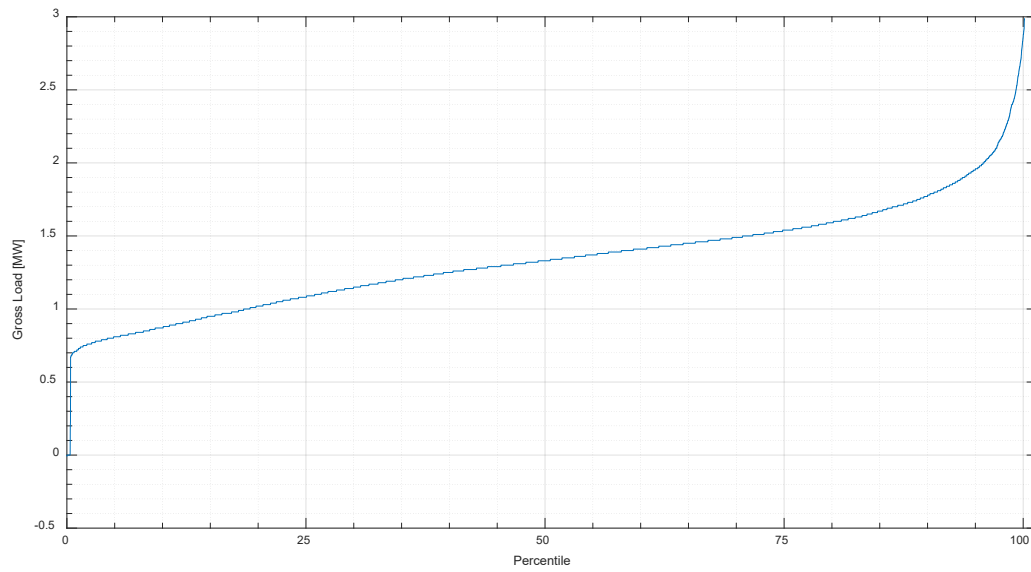

604

605

606

607

Figure 41: 2019 Load Percentile Gross Load Data at 31W2

NH – SYSTEM ENGINEERING

DISTRIBUTION SYSTEM PLANNING

2020 – 2029 LOAD FLOW STUDY

July 1, 2020

Revised December 2, 2020 - Incorporates criteria changes from the September 2020 release of the Distribution System Planning Guide.

Company Confidential

Approved by Manager – Distribution Planning:

Russel D Johnson
Russel D. Johnson

Table of Contents

Executive Summary	2
Planned Projects	4
Bulk Electric System Study	6
2020	7
2021	13
2022	19
2023	25
2024	31
2025	37
2029	43
Bulk Feeder Contingency Study	49
2020	50
2021	54
2022	58
2023	62
2024	66
2025	70
2029	74
Bulk Substation Bus Fault Study	78
2020	79
2021	83
2022	87
2023	91
2024	95
2025	98
2029	101
Appendix A: Contingencies Studied	104

Executive Summary

The purpose of this study is to identify the system operating condition and any violations of operating parameters both during base case and contingent system operations in the upcoming 10-year time frame. Solutions noted in this report are preliminary. Final solutions are identified through additional detailed studies of the specific violations.

The equipment operating limits that were studied were identified using the PSS/E power flow program. The New Hampshire load flow model was updated to include system additions as well as changes in substation loading.

Beginning in 2016, System Planning began forecasting future load growth by substation in conjunction with the Eversource Sales and Revenue Forecasting Group. Overall Eversource NH projected annual growth rate between 2020 – 2029 is 0.38%.

This document identifies system overloads or voltage violations in accordance with the Eversource Distribution System Planning Guide. The criteria used in this report for Base Case violations identifies bulk transformers that exceed 95% nameplate, circuit conductors that exceed 100% of the normal rating, and a circuit voltage that is less than 97.5% or 95% depending on installed voltage regulation.

This document also identifies system overloads, voltage violations, isolated load during an N-1 contingency of a bulk transformer, or N-1 transmission event that results in a contingency greater than N-1 on the distribution system in accordance with Eversource's Distribution System Planning Guide. The criteria used in this report for an N-1 contingency violation identifies bulk transformers that exceed 100% Long Term Emergency rating (LTE), circuit conductors that exceed 100% LTE rating, and a circuit voltage that is less than 95%. During an N-1 contingency event, restoration switching is limited to three load blocks. As needed, one of those three load blocks may be utilized to increase capacity of the substation restoring load. If this load transfer (known as cascading load) was performed, it is noted in the comments field. Feeder breaker and radial transmission line contingencies were also studied to identify system deficiencies where continuity of service to customers is at risk.

Although the Distribution System Planning Guide prescribes customer voltage limits, the PSS/E power flow model is of only three-phase circuit backbones with spot loads representing customer load along a line. The 34.5 kV line voltage limits identified in Eversource's former NH System Planning document, ED-3002, were utilized in this study. The voltage limits identified in that document factor in voltage drop between the main line to the customer meter (primary laterals, distribution transformers, and secondary/service conductors) to meet standard customer voltage limits.

For all studies in this report, the following assumptions were made about generators interconnected to the distribution system in New Hampshire:

- Since water flows are typically minimal during the summer months, all hydro generators were modeled offline.
- Due to the intermittent nature of wind generation, wind interconnections were modeled offline.
- Indeck Energy's Alexandria facility, which stopped producing power in 2017, was modeled offline.
- Biomass, landfill gas, and trash incinerator generators are dependable and produce constant power output. These units were kept online in the study models. Based on Eversource planning guidelines, the largest generator in an area is modeled offline to ensure sufficient system capacity.

When reviewing the tables in the following chapters, the differences between the Loading MW/MVA and the Loading % columns should be noted. The Loading % is calculated based on the total power flow through the transformer (transformer losses and delivered load) divided by the transformer rating. The Loading MW/MVA is the load being delivered to substation load and feeders, *excluding transformer losses*. By identifying the MW/MVA loading this way, it allows direct comparison to metered data from the low-side of the transformer.

Planned Projects

This section contains a summary of each planned capital project that is included in this study. The in-service date of the projects dictates the study year. If the project's planned in-service date is prior June 1st, then the study year is same as the in-service year. However, if the project is going in service after June 1st, then the study year is the year following the in-service year. Projects are described by study year as follows:

2020

- **310-345 Circuit Tie:** This circuit tie consists of 4 miles of 477 Spacer Cable and ties the end of the 310 line at Weirs Substation (Pole 91/62 on the 29X1), to a point very near the end of the 345 line at the 345X5 Tap on Eastman Road in Laconia (Pole 42/26 on the 345X5 Circuit). This project was completed and the tie in-service in May 2020.
- **Lost Nation Substation Transformer Addition:** A second 44.8 MVA transformer was added to the existing TB033 44.8 MVA transformer at Lost Nation, going in service May 2019.
- **328 Line Reconductoring:** The 328 Line out of Rimmon Substation, which consists of 4.18 miles of length, has been reconducted with 477 Spacer Cable.
- **Greggs Substation Retirement:** Greggs Substation transformer TB17 has been retired a substation load has been transferred to Rimmon Substation.

2021

- **Portsmouth Substation Rebuild:** The existing Portsmouth TB156 44.8 MVA transformer will be replaced with a 62.5 MVA transformer, with the addition of a second transformer equal in size. Project delays have postponed having both new transformers in service by the end of 2020. The new 62.5 MVA transformer, TX107, is expected to go into service in late December 2020 and the replacement of the 44.8 MVA unit expected in 2021.
- **Pemigewasset (also referred to as "Pemi") Substation Transformer Upgrade:** The existing Pemigewasset TB88 25 MVA transformer will be replaced with a 62.5 MVA unit, went in service November 2020.
- **Eddy Control House:** New control house with transformer protection scheme.
- **Weirs Regulator Upgrade:** The existing 34.5 kV 3-100 Amp regulators at Weirs Substation have been replaced with a 3-335 Amp (667 kVA) units. In addition, a total of three 1.8 MVAR capacitor banks were installed on the 345X5 circuit and the 34.5 kV portion of 29X1 circuit. Planned to be in-service by Fall 2020, these capacitors were installed in May of 2020.

2022

- **Emerald Street Substation Rebuild:** The transformers TB7 (22.4 MVA), TB18 (12.5 MVA) and TB23 (12.5 MVA) at Emerald Street Substation (formerly named Keene Substation) will be replaced with two 30 MVA rated transformers TX123 and TX136. TB12 transformer is retired as of May 2017, and TB3 transformer will remain in service. Planned in-service date December 2021.

2023

- **Monadnock Substation Transformers Upgrade:** The existing Monadnock transformers TB40 (20 MVA) and TB80 (28 MVA), will be replaced with two 62.5 MVA transformers. Planned in-service date is December 2022.

2024

- **South Milford:** The existing South Milford transformer TB86 rated 44.8 MVA, will be replaced with a 62.5 MVA transformer and supplemented with a second 62.5 MVA transformer. A new distribution line will be constructed to supply the 314X12 load, in addition to substation feeder position rearrangement. Planned in-service date is December 2023.
- **White Lake Substation Transformers Upgrade:** The existing White Lake transformers TB76 and TB82 rated 28 MVA, will be replaced with two 62.5 MVA transformers with a normally open bus-tie breaker. Circuit ties outside the substation will be automated. Planned in-service date for this study is December 2023.

2025

- **Cocheco Street (Dover) Substation Transformers Upgrade:** The existing Cocheco Substation transformers TB22 and TB55 rated 44.8 MVA, will be replaced with two 62.5 MVA transformers, with the installation of a normally open bus tie breaker. Planned in-service date is December 2024.

Bulk Electric System Study

The following chapter is a year-by-year review of Eversource system design violations for each New Hampshire region. The criteria for identifying violations to be listed in this section are as follows:

	Base Case	N-1 Contingency
Bulk Transformer Loading	> 95% nameplate	> 100% LTE
Line Loading	> 100% normal	> 100% emergency
Voltage, Unregulated Load	< 97.5%	< 95%
Voltage, Regulated Load	< 95%	< 92.5%
Load Block Transfer Limit	n/a	3
Remaining Isolated Load	n/a	> 0 MW

Definitions:

Regulated Load Load that has voltage regulation at a 34.5kV primary voltage beyond the Bulk Distribution Facility. The system load is all beyond a PSNH voltage regulated source (line regulator on a tap or non-bulk substation LTC). Primary metered customers are considered regulated load because regulation is their responsibility in accordance with the Tariff.

Unregulated Load Load that has no voltage regulation at the 34.5 kV primary voltage beyond a Bulk Distribution Facility. The voltage of the system load is not regulated beyond the 34.5 kV point modeled for planning by System Planning and Strategy.

2020

Assumptions

Scheduled construction complete prior to June 1, 2020.

- Lost Nation Substation 44.8 MVA second transformer has been added.
- Rimmon 328 line has been reconducted with 477 Spacer Cable.
- Greggs Substation has been retired.

General Discussion

For 2020, the following violations were identified:

- 3 transformers exceed 95% base case nameplate loading
- 3 circuits have voltage that is less than 0.975 per unit
- 23 substations have N-1 contingency violations

Suggested Projects

The following projects are suggested to address violations. This is a partial list of solution options as some violations require a local study to be performed to determine a feasible solution. The projects proposed here require additional study to determine if they are the most technically and economically feasible solution for the violation identified.

Base Case Solution Options

- Cocheco Street (Dover) 32X3
 - A planned capacitor bank installation will address this voltage violation and raise steady-state voltage above 0.975 Vpu.
- Scobie Pond 32W4
 - Install a capacitor bank or voltage regulators to raise steady-state voltage above 0.975 Vpu.

N-1 Contingency Solution Options

- Loss of Laconia TB24 or TB125 (STE Violation)
 - Transfer load to Daniel substation to reduce loading below minimum STE rating.
- Loss of Madbury TB65 or TB74 (STE Violation)
 - Transfer load to Brentwood and Ocean Rd substations to reduce loading below minimum STE rating.
- Loss of Mill Pond TB171
 - Install additional SCADA controlled devices in the Portsmouth 12.47 kV distribution system and increase load transfer capability.
- Loss of Rochester TB53 or TB57 (STE Violation)
 - Transfer load to Tasker Farm substation to reduce loading below minimum STE rating.

Central Region

Central Region - Base Case Violations (2020)					
Transformer Violations					
Substation	XFMR	XFMR Rating (MVA)	Loading (MW/MVA)	(%)	Notes
<i>No violations identified.</i>					
Circuit Violations					
Substation	Circuit	Line Rating (MVA)	Loading (MW/MVA)	(%)	Notes
<i>No violations identified.</i>					

Central Region - Contingency Violations (2020)				
Substation	XFMR or T Line	LTE/STE XFMR Rating (MVA)	Isolated Load (MW)	Notes
Eddy	TB26, TB81	54/61, 56/62	0.0	STE violation. Load exceeds STE by 9 MVA. No switching is possible to offload this station
Huse Rd	TB46, TB58	58/69, 56/62	0.0	STE violation. Load exceeds STE by 14.7 MVA. No switching is possible to offload this station

Eastern Region

Eastern Region - Base Case Violations (2020)					
Transformer Violations					
Substation	XFMR	XFMR Rating (MVA)	Loading (MW/MVA)	(%)	Notes
Portsmouth	TB156	44.8	42.0/42.0	96%	Will be upgraded with addition of 2nd XFMR, scheduled for July 2020
Circuit Violations					
Substation	Circuit	Line Rating (MVA)	Loading (MW/MVA)	(%)	Notes
Cochecho Street (Dover)	32X3				Low voltage beyond 32X3J53 (0.973 Vpu). Cap bank installation is Recommended

Eastern Region – Contingency Violations (2020)				
Substation	XFMR or T Line	LTE/STE XFMR Rating (MVA)	Isolated Load (MW)	Notes
Mill Pond	TB171	34/45	10.6	Limited by Cutts St, Foyes Corner, Jackson Hill and Lafayette Rd XFMRs; Manual Switches; Breakers CT; Solid Cutouts. Additional 1 MW can be restored via manual switching. Need DA devices to sectionalize the lines and pick up load partially
Cochecho Street (Dover)	TB22, TB55	51/54, 53/61	0	STE violation. Load exceeds STE by 26.1 MVA. No switching is possible to offload this station. Transformer replacement would solve this violation, scheduled for 2024
Madbury	TB65, TB74	56/62, 54/64	0	STE violation. Load exceeds STE by 16.9 MVA. Load can be transferred to Brentwood and Ocean Rd substations
Rochester	TB53, TB57	56/61, 56/67	0	STE Violation. Load exceeded STE by 2.3 MVA. Load can be transferred to Tasker Farm substation

Northern Region

Northern Region - Base Case Violations (2020)					
Transformer Violations					
Substation	XFMR	XFMR Rating (MVA)	Loading (MW/MVA)	(%)	Notes
White Lake	TB82	28.0	26.5/26.6	95%	To be upgraded by December 2023
Circuit Violations					
Substation	Circuit	Line Rating (MVA)	Loading (MW/MVA)	(%)	Notes
<i>No violations identified.</i>					

Northern Region – Contingency Violations (2020)					
Substation	XFMR or T Line	LTE/STE XFMR Rating (MVA)	Isolated Load (MW)	Notes	
Beebe River	TB62	53/61	14.9	Limited by Ashland XFMR overload (at 117% LTE if entire load is restored). Isolated 342B and portion of 342A lines. New Pemi XFMR, cap bank installation on 338 line and double cascading allow to restore entire load	
White Lake	TB76, TB82	34/39, 33/39	14.5	LTE violation. White Lake XFMRs Will be upgraded by December 2023. Isolated Wolfeboro Municipal due to LTE of remaining transformer STE violation. Load exceeds STE by 12.4 MVA. No switching is possible to offload this station. Transformer replacement would solve this violation, scheduled for 2023. Isolated Wolfeboro Municipal due to LTE of remaining XFMR	
			14.5		
North Woodstock	TB67	54/64	10.8	Requires system upgrades on NHEC's system to utilize Thornton-North Woodstock circuit tie	
Ashland	TB5	53/64	8.3	Requires load cascading. Limited by the mobile & White Lake XFMRs overload, voltage on 338 line and 345 line overload 3.73 miles of 336 ACSR from Pemi breaker to 345X2 tap. Isolated NHEC Moultonboro. Cap bank installation at Straits Rd and line reconductoring are recommended once Pemi XFMR has been upgraded	
Saco Valley	TB60	53/62	6.9	Requires load cascading. Limited by White Lake XFMRs which will be upgraded by December 2023	
Mobile at Pemigewasset	TX106	35/35	1.8	Requires cascading load. Limited by low voltage on the 3114X line. Installation of 2x 1.8 MVAR cap banks would allow complete restoration	
Laconia	TB24, TB125	48/62, 54/66	0.0	STE violation. Load exceeds STE by 3.1 MVA. Load can be transferred to Daniel substation	

Southern Region

Southern Region - Base Case Violations (2020)					
Transformer Violations					
Substation	XFMR	XFMR Rating (MVA)	Loading (MW/MVA)	(%)	Notes
So. Milford	TB86	44.8	46.4/46.8	105%	
Circuit Violations					
Substation	Circuit	Line Rating (MVA)	Loading (MW/MVA)	(%)	Notes
Scobie	32W4				Kendall Pond voltage<0.975 (.96 PU)

Southern Region – Contingency Violations (2020)				
Substation	XFMR or T Line	LTE/STE XFMR Rating (MVA)	Isolated Load (MW)	Notes
Scobie Pond	N124		24.6	Minimum exposure due to its short length and to being entirely contained within the Scobie Pond Substation property
Long Hill	P134		17.3	Limited by Bridge Street TB45 & TB52 LTE ratings and 3891 336 ACSR (0.59 miles) from P. 3891/63 to P. 3891/51. Isolated 3154. All Load restored in 5 load block transfers
Bridge Street	G192		13.8	Isolated load can be reduced to 7.8 MW after 4 load block transfers. Bridge Street TB15C would remain isolated
South Milford	TB86	55/67	10.7	Requires double load cascading and restoring via S. Milford bus tie
Bridge Street	TB15C	13/15	7.8	No SCADA switching on the Nashua 4 kV
Long Hill	TB10, TB20	53/62, 56/62	0.0	STE violation. Load exceeds STE by 7.4 MVA. No switching is possible to offload this station

Western Region

Western Region - Base Case Violations (2020)					
Transformer Violations					
Substation	XFMR	XFMR Rating (MVA)	Loading (MW/MVA)	(%)	Notes
<i>No violations identified.</i>					
Circuit Violations					
Substation	Circuit	Line Rating (MVA)	Loading (MW/MVA)	(%)	Notes
North Keene	76W1				Court Street<0.975 (0.969 PU)

Western Region – Contingency Violations (2020)				
Substation	XFMR/ T Line	LTE/STE XFMR Rating (MVA)	Isolated Load (MW)	Notes
Monadnock	TB40, TB80	28/30, 34/38	5.5	LTE violation. Limited by LTE rating of the remaining and 313 line 6.72 miles of 4/0 ACSR from P. 313/1 to P. 313/121
			5.5	STE violation. Load exceeds STE by 7.5 MVA. Transformer replacement would solve this violation, scheduled for 2022. Isolated load limitation as in LTE violation.
Chestnut Hill	TB87, TB98	16/18, 16/18	4.0	Limited by LTE rating of the remaining Chestnut transformer at 105% LTE

2021

Assumptions

Scheduled construction complete prior to June 1, 2021.

- Portsmouth Substation transformer has been upgraded and a second transformer has been added.
- Emerald Street Substation has been rebuilt.
- New Eddy Control House has been built with load shed scheme

General Discussion

For 2021, the following new planning criteria violations were identified:

- 1 transformer exceeds 95% base case nameplate loading
- 0 circuits have voltage that is less than 0.975 per unit
- 0 substations have new N-1 contingency violations

Any new planning criteria violations are presented in bold within the following tables.

Suggested Projects

The following projects are suggested to address violations. This is a partial list of solution options as some violations require a local study to be performed to determine a feasible solution. The projects proposed here require additional study to determine if they are the optimal solution for the violation identified. Solution options noted in earlier years of study are not included.

Base Case Solution Options

- Great Bay TB141
 - Unitil Energy System to shift more load onto Timber Swamp Substation. Unitil has chosen to perform this switching seasonally during the summer.

Central Region

Central Region - Base Case Violations (2021)					
Transformer Violations					
Substation	XFMR	XFMR Rating (MVA)	Loading (MW/MVA)	(%)	Notes
<i>No violations identified.</i>					
Circuit Violations					
Substation	Circuit	Line Rating (MVA)	Loading (MW/MVA)	(%)	Notes
<i>No violations identified.</i>					

Central Region - Contingency Violations (2021)				
Substation	XFMR or T Line	LTE/STE XFMR Rating (MVA)	Isolated Load (MW)	Notes
Eddy	TB26, TB81	54/61, 56/62	0.0	STE violation. Load exceeds STE by 9.4 MVA. No switching is possible to offload this station
Huse Rd	TB46, TB58	58/69, 56/62	0.0	STE violation. Load exceeds STE by 15.1 MVA. No switching is possible to offload this station

Eastern Region

Eastern Region - Base Case Violations (2021)					
Transformer Violations					
Substation	XFMR	XFMR Rating (MVA)	Loading (MW/MVA)	(%)	Notes
Great Bay	TB141	44.8	42/42.1	96%	Unitil to offload more load to Timber Swamp
Circuit Violations					
Substation	Circuit	Line Rating (MVA)	Loading (MW/MVA)	(%)	Notes
Cocheco Street (Dover)	32X3				Low voltage beyond 32X3J53 (0.973 Vpu). Cap bank installation is Recommended

Eastern Region – Contingency Violations (2021)				
Substation	XFMR or T Line	LTE/STE XFMR Rating (MVA)	Isolated Load (MW)	Notes
Mill Pond	TB171	34/45	11.1	Limited by Cutts St, Foyes Corner, Jackson Hill and Lafayette Rd XFMRs; Manual Switches; Breakers CT; Solid Cutouts. Additional 1 MW can be restored via manual switching. Need DA devices to sectionalize the lines and pick up load partially
Cocheco Street (Dover)	TB22, TB55	51/54, 53/61	0	STE violation. Load exceeds STE by 27 MVA. No switching is possible to offload this station. Transformer replacement would solve this violation, scheduled for 2024
Madbury	TB65, TB74	56/62, 54/64	0	STE violation. Load exceeds STE by 17.1 MVA. Load can be transferred to Brentwood and Ocean Rd substations
Rochester	TB53, TB57	56/61, 56/67	0	STE Violation. Load exceeded STE by 2.6 MVA. Load can be transferred to Tasker Farm substation

New violations for this year are presented in bold.

Northern Region

Northern Region - Base Case Violations (2021)					
Transformer Violations					
Substation	XFMR	XFMR Rating (MVA)	Loading (MW/MVA)	(%)	Notes
White Lake	TB82	28.0	26.5/26.7	95%	To be upgraded by December 2023
Circuit Violations					
Substation	Circuit	Line Rating (MVA)	Loading (MW/MVA)	(%)	Notes
<i>No violations identified.</i>					

Northern Region – Contingency Violations (2021)					
Substation	XFMR or T Line	LTE/STE XFMR Rating (MVA)	Isolated Load (MW)	Notes	
Beebe River	TB62	53/61	15.1	Limited by Ashland XFMR overload (at 118% LTE if entire load is restored). Isolated 342B and portion of 342A lines. Cap bank installation on 338 line and double cascading allow to restore entire load	
White Lake	TB76, TB82	34/39, 33/39	14.5	Limited by the remaining White Lake XFMR, which exceeds STE rating. White Lake XFMRs Will be upgraded by December 2023. Isolated Wolfeboro Municipal	
			14.5	STE violation. Load exceeds STE by 12.7 MVA. No switching is possible to offload this station. Transformer replacement would solve this violation, scheduled for 2023. Isolated Wolfeboro Municipal due to LTE of remaining XFMR	
North Woodstock	TB67	54/64	10.9	Requires system upgrades on NHEC's system to utilize Thornton-North Woodstock circuit tie	
Saco Valley	TB60	53/62	9.3	Requires load cascading. Limited by White Lake XFMRs which will be upgraded by December 2023	
Ashland	TB5	53/64	8.4	Requires load cascading. Limited by White Lake XFMRs overload, voltage on 338 line. Without cascading, 345 line (3.73 miles of 336 ACSR from Pemi breaker to 345X2 Tap) would be at 110% emergency rating. Isolated NHEC Moultonboro. Cap bank installation at Straits Rd and line reconductoring are recommended	
Pemigewasset	TX88	80/93	1.9	Requires cascading load. Limited by low voltage on the 3114X line. Installation of 2x 1.8 MVAR cap banks would allow complete restoration	
Laconia	TB24, TB125	48/62, 54/66	0.0	STE violation. Load exceeds STE by 3.5 MVA. Load can be transferred to Daniel substation	

Southern Region

Southern Region - Base Case Violations (2021)					
Transformer Violations					
Substation	XFMR	XFMR Rating (MVA)	Loading (MW/MVA)	(%)	Notes
So. Milford	TB86	44.8	48.6/48.8	111%	
Circuit Violations					
Substation	Circuit	Line Rating (MVA)	Loading (MW/MVA)	(%)	Notes
Scobie	32W4				Kendall Pond voltage<0.975 (.96 PU)

Southern Region – Contingency Violations (2021)				
Substation	XFMR or T Line	LTE/STE XFMR Rating (MVA)	Isolated Load (MW)	Notes
Scobie Pond	N124		24.7	Minimum exposure due to its short length and to being entirely contained within the Scobie Pond Substation property
Long Hill	P134		17.5	Limited by Bridge Street TB45 & TB52 LTE ratings and 3891 336 ACSR (0.59 miles) from P. 3891/63 to P. 3891/51. Isolated 3154. All Load restored in 5 load block transfers
Bridge Street	G192		13.9	Isolated load can be reduced to 7.8 MW after 4 load block transfers. Bridge Street TB15C would remain isolated
South Milford	TB86	55/67	10.8	Requires double load cascading and restoring via S. Milford bus tie
Bridge Street	TB15C	13/15	7.8	No SCADA switching on the Nashua 4 kV
Long Hill	TB10, TB20	53/62, 56/62	0.0	STE violation. Load exceeds STE by 7.8 MVA. No switching is possible to offload this station

Western Region

Western Region - Base Case Violations (2021)					
Transformer Violations					
Substation	XFMR	XFMR Rating (MVA)	Loading (MW/MVA)	(%)	Notes
<i>No violations identified.</i>					
Circuit Violations					
Substation	Circuit	Line Rating (MVA)	Loading (MW/MVA)	(%)	Notes
North Keene	76W1				Court Street<0.975 (0.957 PU)

Western Region – Contingency Violations (2021)				
Substation	XFMR or T Line	LTE/STE XFMR Rating (MVA)	Isolated Load (MW)	Notes
Monadnock	TB40, TB80	28/30, 34/38	5.6	Limited by LTE rating of the remaining and 313 line 6.72 miles of 4/0 ACSR from P. 313/1 to P. 313/121
			5.6	STE violation. Load exceeds STE by 7.8 MVA. Transformer replacement would solve this violation, scheduled for 2022. Isolated load limitation as in LTE violation.
Chestnut Hill	TB87, TB98	16/18, 16/18	4.0	Limited by LTE rating of the remaining Chestnut transformer at 105% LTE

2022

Assumptions

Scheduled construction complete prior to June 1, 2022.

- Emerald Street Substation has been rebuilt.
- Two 1.8 MVAR capacitor banks have been installed on the 3114X line.

General Discussion

For 2022, the following new planning criteria violations were identified:

- 0 transformers exceed 95% base case nameplate loading
- 0 circuits have voltage that is less than 0.975 per unit
- 2 substations have new N-1 contingency violations

Any new planning criteria violations are presented in bold within the following tables.

Suggested Projects

The following projects are suggested to address violations. This is a partial list of solution options as some violations require a local study to be performed to determine a feasible solution. The projects proposed here require additional study to determine if they are the optimal solution for the violation identified. Solution options noted in earlier years of study are not included.

N-1 Contingency Solution Options

- Loss of Pine Hill TB118 or TB161 (STE Violation)
 - No switching is possible to offload this station. Transformer upgrade is recommended.

Central Region

Central Region - Base Case Violations (2022)					
Transformer Violations					
Substation	XFMR	XFMR Rating (MVA)	Loading (MW/MVA)	(%)	Notes
<i>No violations identified.</i>					
Circuit Violations					
Substation	Circuit	Line Rating (MVA)	Loading (MW/MVA)	(%)	Notes
<i>No violations identified.</i>					

Central Region - Contingency Violations (2022)				
Substation	XFMR or T Line	LTE/STE XFMR Rating (MVA)	Isolated Load (MW)	Notes
Eddy	TB26, TB81	54/61, 56/62	0.0	STE violation. Load exceeds STE by 9.6 MVA. No switching is possible to offload this station
Huse Rd	TB46, TB58	58/69, 56/62	0.0	STE violation. Load exceeds STE by 15.4 MVA. No switching is possible to offload this station
Pine Hill	TB118, TB161	54/66, 55/59	0.0	STE violation. Load exceeds STE by 0.2 MVA. No switching is possible to offload this station

New violations for this year are presented in bold.

Eastern Region

Eastern Region - Base Case Violations (2022)					
Transformer Violations					
Substation	XFMR	XFMR Rating (MVA)	Loading (MW/MVA)	(%)	Notes
Great Bay	TB141	44.8	42.4/42.5	97%	Unitil to offload more load to Timber Swamp
Circuit Violations					
Substation	Circuit	Line Rating (MVA)	Loading (MW/MVA)	(%)	Notes
Cocheco Street (Dover)	32X3				Low voltage beyond 32X3J53 (0.973 Vpu). Cap bank installation is Recommended

Eastern Region – Contingency Violations (2022)				
Substation	XFMR or T Line	LTE/STE XFMR Rating (MVA)	Isolated Load (MW)	Notes
Mill Pond	TB171	34/45	11.2	Limited by Cutts St, Foyes Corner, Jackson Hill and Lafayette Rd XFMRs; Manual Switches; Breakers CT; Solid Cutouts. Additional 1 MW can be restored via manual switching. Need DA devices to sectionalize the lines and pick up load partially
Cocheco Street (Dover)	TB22, TB55	51/54, 53/61	0.0	STE violation. Load exceeds STE by 27.2 MVA. No switching is possible to offload this station. Transformer replacement would solve this violation, scheduled for 2024
Madbury	TB65, TB74	56/62, 54/64	0.0	STE violation. Load exceeds STE by 17.2 MVA. Load can be transferred to Brentwood and Ocean Rd substations
Rochester	TB53, TB57	56/61, 56/67	0.0	STE Violation. Load exceeded STE by 2.7 MVA. Load can be transferred to Tasker Farm substation

Northern Region

Northern Region - Base Case Violations (2022)					
Transformer Violations					
Substation	XFMR	XFMR Rating (MVA)	Loading (MW/MVA)	(%)	Notes
White Lake	TB82	28.0	26.8/26.8	96%	To be upgraded by December 2023
Circuit Violations					
Substation	Circuit	Line Rating (MVA)	Loading (MW/MVA)	(%)	Notes
<i>No violations identified.</i>					

Northern Region – Contingency Violations (2022)					
Substation	XFMR or T Line	LTE/STE XFMR Rating (MVA)	Isolated Load (MW)	Notes	
Beebe River	TB62	53/61	15.2	Limited by Ashland XFMR overload (at 118% LTE if entire load is restored). Isolated 342B and portion of 342A lines. Cap bank installation on 338 line and double cascading allow to restore entire load	
White Lake	TB76, TB82	34/39, 33/39	14.5	Limited by the remaining White Lake XFMR, which exceeds STE rating. White Lake XFMRs Will be upgraded by December 2023. Isolated Wolfeboro Municipal	
			14.5	STE violation. Load exceeds STE by 12.9 MVA. No switching is possible to offload this station. Transformer replacement would solve this violation, scheduled for 2023. Isolated Wolfeboro Municipal due to LTE of remaining XFMR	
North Woodstock	TB67	54/64	11.0	Requires system upgrades on NHEC's system to utilize Thornton-North Woodstock circuit tie	
Saco Valley	TB60	53/62	9.3	Requires load cascading. Limited by White Lake XFMRs which will be upgraded by December 2023	
Ashland	TB5	53/64	8.4	Requires load cascading. Limited by White Lake XFMRs overload, voltage on 338 line. Without cascading, 345 line (3.73 miles of 336 ACSR from Pemi breaker to 345X2 Tap) would be at 110% emergency rating. Isolated NHEC Moultonboro. Cap bank installation at Straits Rd and line reconductoring are recommended	
Laconia	TB24, TB125	48/62, 54/66	0.0	STE violation. Load exceeds STE by 3.8 MVA. Load can be transferred to Daniel substation	

Southern Region

Southern Region - Base Case Violations (2022)					
Transformer Violations					
Substation	XFMR	XFMR Rating (MVA)	Loading (MW/MVA)	(%)	Notes
So. Milford	TB86	44.8	48.6/48.8	111%	
Circuit Violations					
Substation	Circuit	Line Rating (MVA)	Loading (MW/MVA)	(%)	Notes
Scobie	32W4				Kendall Pond voltage<0.975 (.96 PU)

Southern Region – Contingency Violations (2022)				
Substation	XFMR or T Line	LTE/STE XFMR Rating (MVA)	Isolated Load (MW)	Notes
Scobie Pond	N124		24.8	Minimum exposure due to its short length and to being entirely contained within the Scobie Pond Substation property
Long Hill	P134		17.5	Limited by Bridge Street TB45 & TB52 LTE ratings and 3891 336 ACSR (0.59 miles) from P. 3891/63 to P. 3891/51. Isolated 3154. All Load restored in 5 load block transfers
Bridge Street	G192		14.0	Isolated load can be reduced to 7.9 MW after 4 load block transfers. Bridge Street TB15C would remain isolated
South Milford	TB86	55/67	10.9	Requires double load cascading and restoring via S. Milford bus tie
Bridge Street	TB15C	13/15	7.9	No SCADA switching on the Nashua 4 kV
Lawrence Road	TB48	178/201	2.0	Limited by Hudson transformers, Hudson 389 pick-up setting, 389 477 ACSR from Hudson to Edgeville Tap (1.94 miles), 3128R1 pick-up setting and 3128 336 ACSR from Mammoth Road to 4/44 (1.24 miles)
Long Hill	TB10, TB20	53/62, 56/62	0.0	STE violation. Load exceeds STE by 8 MVA. No switching is possible to offload this station

New violations for this year are presented in bold.

Western Region

Western Region - Base Case Violations (2022)					
Transformer Violations					
Substation	XFMR	XFMR Rating (MVA)	Loading (MW/MVA)	(%)	Notes
<i>No violations identified.</i>					
Circuit Violations					
Substation	Circuit	Line Rating (MVA)	Loading (MW/MVA)	(%)	Notes
North Keene	76W1				Court Street<0.975 (0.956 PU)

Western Region – Contingency Violations (2022)				
Substation	XFMR or T Line	LTE/STE XFMR Rating (MVA)	Isolated Load (MW)	Notes
Monadnock	TB40, TB80	28/30, 34/38	5.6	Limited by LTE rating of the remaining and 313 line 6.72 miles of 4/0 ACSR from P. 313/1 to P. 313/121
			5.6	STE violation. Load exceeds STE by 8 MVA. Transformer replacement would solve this violation, scheduled for 2022. Isolated load limitation as in LTE violation.
Chestnut Hill	TB87, TB98	16/18, 16/18	4.1	Limited by LTE rating of the remaining Chestnut transformer at 106% LTE

2023

Assumptions

Scheduled construction prior to June 1, 2023.

- Monadnock Substation transformers have been upgraded.

General Discussion

For 2023, the following new planning criteria violations were identified:

- 0 transformers exceed 95% base case nameplate loading
- 0 circuits have steady-state voltage that is less than 0.975 per unit
- 0 substations have new N-1 contingency violations

Any new planning criteria violations are presented in bold within the following tables.

Central Region

Central Region - Base Case Violations (2023)					
Transformer Violations					
Substation	XFMR	XFMR Rating (MVA)	Loading (MW/MVA)	(%)	Notes
<i>No violations identified.</i>					
Circuit Violations					
Substation	Circuit	Line Rating (MVA)	Loading (MW/MVA)	(%)	Notes
<i>No violations identified.</i>					

Central Region - Contingency Violations (2023)				
Substation	XFMR or T Line	LTE/STE XFMR Rating (MVA)	Isolated Load (MW)	Notes
Eddy	TB26, TB81	54/61, 56/62	0.0	STE violation. Load exceeds STE by 9.8 MVA. No switching is possible to offload this station
Huse Rd	TB46, TB58	58/69, 56/62	0.0	STE violation. Load exceeds STE by 15.6 MVA. No switching is possible to offload this station
Pine Hill	TB118, TB161	54/66, 55/59	0.0	STE violation. Load exceeds STE by 0.3 MVA. No switching is possible to offload this station

Eastern Region

Eastern Region - Base Case Violations (2023)					
Transformer Violations					
Substation	XFMR	XFMR Rating (MVA)	Loading (MW/MVA)	(%)	Notes
Great Bay	TB141	44.8	42.8/42.9	98%	Unitil to offload more load to Timber Swamp
Circuit Violations					
Substation	Circuit	Line Rating (MVA)	Loading (MW/MVA)	(%)	Notes
<i>No violations identified.</i>					

Eastern Region – Contingency Violations (2023)				
Substation	XFMR or T Line	LTE/STE XFMR Rating (MVA)	Isolated Load (MW)	Notes
Mill Pond	TB171	34/45	11.2	Limited by Cutts St, Foyes Corner, Jackson Hill and Lafayette Rd XFMRs; Manual Switches; Breakers CT; Solid Cutouts. Additional 1 MW can be restored via manual switching. Need DA devices to sectionalize the lines and pick up load partially
Cochecho Street (Dover)	TB22, TB55	51/54, 53/61	0.0	STE violation. Load exceeds STE by 27.3 MVA. No switching is possible to offload this station. Transformer replacement would solve this violation, scheduled for 2024
Madbury	TB65, TB74	56/62, 54/64	0.0	STE violation. Load exceeds STE by 17.2 MVA. Load can be transferred to Brentwood and Ocean Rd substations
Rochester	TB53, TB57	56/61, 56/67	0.0	STE Violation. Load exceeded STE by 2.9 MVA. Load can be transferred to Tasker Farm substation

Northern Region

Northern Region - Base Case Violations (2023)					
Transformer Violations					
Substation	XFMR	XFMR Rating (MVA)	Loading (MW/MVA)	(%)	Notes
White Lake	TB82	28.0	26.8/26.9	96%	To be upgraded by December 2023
Circuit Violations					
Substation	Circuit	Line Rating (MVA)	Loading (MW/MVA)	(%)	Notes
<i>No violations identified.</i>					

Northern Region – Contingency Violations (2023)					
Substation	XFMR or T Line	LTE/STE XFMR Rating (MVA)	Isolated Load (MW)	Notes	
Beebe River	TB62	53/61	15.2	Limited by Ashland XFMR overload (at 119% LTE if entire load is restored). Isolated 342B and portion of 342A lines. Cap bank installation on 338 line and double cascading allow to restore entire load	
White Lake	TB76, TB82	34/39, 33/39	14.5	Limited by the remaining White Lake XFMR, which exceeds STE rating. White Lake XFMRs Will be upgraded by December 2023. Isolated Wolfeboro Municipal	
			14.5	STE violation. Load exceeds STE by 13.1 MVA. No switching is possible to offload this station. Transformer replacement would solve this violation, scheduled for 2023. Isolated Wolfeboro Municipal due to LTE of remaining XFMR	
North Woodstock	TB67	54/64	11.0	Requires system upgrades on NHEC's system to utilize Thornton-North Woodstock circuit tie	
Saco Valley	TB60	53/62	9.4	Requires load cascading. Limited by White Lake XFMRs which will be upgraded by December 2023	
Ashland	TB5	53/64	8.4	Requires load cascading. Limited by White Lake XFMRs overload, voltage on 338 line. Without cascading, 345 line (3.73 miles of 336 ACSR from Pemi breaker to 345X2 Tap) would be at 110% emergency rating. Isolated NHEC Moultonboro. Cap bank installation at Straits Rd and line reconductoring are recommended	
Laconia	TB24, TB125	48/62, 54/66	0.0	STE violation. Load exceeds STE by 4 MVA. Load can be transferred to Daniel substation	

Southern Region

Southern Region - Base Case Violations (2023)					
Transformer Violations					
Substation	XFMR	XFMR Rating (MVA)	Loading (MW/MVA)	(%)	Notes
So. Milford	TB86	44.8	48.8/48.9	111%	
Circuit Violations					
Substation	Circuit	Line Rating (MVA)	Loading (MW/MVA)	(%)	Notes
Scobie	32W4				Kendall Pond voltage<0.975 (.96 PU)

Southern Region – Contingency Violations (2023)				
Substation	XFMR or T Line	LTE/STE XFMR Rating (MVA)	Isolated Load (MW)	Notes
Scobie Pond	N124		24.9	Minimum exposure due to its short length and to being entirely contained within the Scobie Pond Substation property
Long Hill	P134		17.5	Limited by Bridge Street TB45 & TB52 LTE ratings and 3891 336 ACSR (0.59 miles) from P. 3891/63 to P. 3891/51. Isolated 3154. All Load restored in 5 load block transfers
Bridge Street	G192		14.0	Isolated load can be reduced to 7.9 MW after 4 load block transfers. Bridge Street TB15C would remain isolated
South Milford	TB86	55/67	11.0	Requires double load cascading and restoring via S. Milford bus tie
Bridge Street	TB15C	13/15	7.9	No SCADA switching on the Nashua 4 kV
Lawrence Road	TB48	178/201	2.1	Limited by Hudson transformers, Hudson 389 pick-up setting, 389 477 ACSR from Hudson to Edgeville Tap (1.94 miles), 3128R1 pick-up setting and 3128 336 ACSR from Mammoth Road to 4/44 (1.24 miles)
Long Hill	TB10, TB20	53/62, 56/62	0.0	STE violation. Load exceeds STE by 8.1 MVA. No switching is possible to offload this station

Western Region

Western Region - Base Case Violations (2023)					
Transformer Violations					
Substation	XFMR	XFMR Rating (MVA)	Loading (MW/MVA)	(%)	Notes
<i>No violations identified.</i>					
Circuit Violations					
Substation	Circuit	Line Rating (MVA)	Loading (MW/MVA)	(%)	Notes
North Keene	76W1				Court Street<0.975 (0.956 PU)

Western Region – Contingency Violations (2023)				
Substation	XFMR or T Line	LTE/STE XFMR Rating (MVA)	Isolated Load (MW)	Notes
Chestnut Hill	TB87, TB98	16/18, 16/18	4.1	Limited by LTE rating of the remaining Chestnut transformer at 107% LTE

2024

Assumptions

All scheduled construction prior to June 1, 2024 is complete.

- White Lake Substation transformers have been upgraded with automation of circuit ties outside the substation.
- South Milford Substation transformer has been upgraded, a second transformer has been added and new line has been constructed in addition to feeder position rearrangement.
- Cutts Street Substation transformer has been upgraded and portion of 15W4 has been reconnected.
- Mill Pond 71W3 and 71W4 sectionalizing devices have been automated.

General Discussion

For 2024, the following new planning criteria violations were identified:

- 0 transformers exceed 95% base case nameplate loading
- 0 circuits have steady-state voltage that is less than 0.975 per unit
- 0 substations have new N-1 contingency violations

Any new planning criteria violations are presented in bold within the following tables.

Central Region

Central Region - Base Case Violations (2024)					
Transformer Violations					
Substation	XFMR	XFMR Rating (MVA)	Loading (MW/MVA)	(%)	Notes
<i>No violations identified.</i>					
Circuit Violations					
Substation	Circuit	Line Rating (MVA)	Loading (MW/MVA)	(%)	Notes
<i>No violations identified.</i>					

Central Region - Contingency Violations (2024)				
Substation	XFMR or T Line	LTE/STE XFMR Rating (MVA)	Isolated Load (MW)	Notes
Eddy	TB26, TB81	54/61, 56/62	0.0	STE violation. Load exceeds STE by 10 MVA. No switching is possible to offload this station
Huse Rd	TB46, TB58	58/69, 56/62	0.0	STE violation. Load exceeds STE by 15.8 MVA. No switching is possible to offload this station
Pine Hill	TB118, TB161	54/66, 55/59	0.0	STE violation. Load exceeds STE by 0.4 MVA. No switching is possible to offload this station

Eastern Region

Eastern Region - Base Case Violations (2024)					
Transformer Violations					
Substation	XFMR	XFMR Rating (MVA)	Loading (MW/MVA)	(%)	Notes
Great Bay	TB141	44.8	43.2/43.3	99%	Unitil to offload more load to Timber Swamp
Circuit Violations					
Substation	Circuit	Line Rating (MVA)	Loading (MW/MVA)	(%)	Notes
<i>No violations identified.</i>					

Eastern Region - Contingency Violations (2024)				
Substation	XFMR or T Line	LTE/STE XFMR Rating (MVA)	Isolated Load (MW)	Notes
Cochecho Street (Dover)	TB22, TB55	51/54, 53/61	0.0	STE violation. Load exceeds STE by 27.3 MVA. No switching is possible to offload this station. Transformer replacement would solve this violation, scheduled for 2024
Madbury	TB65, TB74	56/62, 54/64	0.0	STE violation. Load exceeds STE by 17.2 MVA. Load can be transferred to Brentwood and Ocean Rd substations
Rochester	TB53, TB57	56/61, 56/67	0.0	STE Violation. Load exceeded STE by 2.9 MVA. Load can be transferred to Tasker Farm substation

Northern Region

Northern Region - Base Case Violations (2024)					
Transformer Violations					
Substation	XFMR	XFMR Rating (MVA)	Loading (MW/MVA)	(%)	Notes
<i>No violations identified.</i>					
Circuit Violations					
Substation	Circuit	Line Rating (MVA)	Loading (MW/MVA)	(%)	Notes
<i>No violations identified.</i>					

Northern Region – Contingency Violations (2024)				
Substation	XFMR or T Line	LTE/STE XFMR Rating (MVA)	Isolated Load (MW)	Notes
Beebe River	TB62	53/61	15.3	Limited by Ashland XFMR overload (at 119% LTE if entire load is restored). Isolated 342B and portion of 342A lines. Cap bank installation on 338 line and double cascading allow to restore entire load
North Woodstock	TB67	54/64	11.0	Requires system upgrades on NHEC's system to utilize Thornton-North Woodstock circuit tie
Ashland	TB5	53/64	8.4	Requires load cascading. Limited by White Lake XFMRs overload, voltage on 338 line. Without cascading, 345 line (3.73 miles of 336 ACSR from Pemi breaker to 345X2 Tap) would be at 110% emergency rating. Isolated NHEC Moultonboro. Cap bank installation at Straits Rd and line reconductoring are recommended
Laconia	TB24, TB125	48/62, 54/66	0.0	STE violation. Load exceeds STE by 4.2 MVA. Load can be transferred to Daniel substation

Southern Region

Southern Region - Base Case Violations (2024)					
Transformer Violations					
Substation	XFMR	XFMR Rating (MVA)	Loading (MW/MVA)	(%)	Notes
<i>No violations identified.</i>					
Circuit Violations					
Substation	Circuit	Line Rating (MVA)	Loading (MW/MVA)	(%)	Notes
Scobie	32W4				Kendall Pond voltage<0.975 (.96 PU)

Southern Region – Contingency Violations (2024)				
Substation	XFMR or T Line	LTE/STE XFMR Rating (MVA)	Isolated Load (MW)	Notes
Scobie Pond	N124		24.9	Minimum exposure due to its short length and to being entirely contained within the Scobie Pond Substation property
Long Hill	P134		17.5	Limited by Bridge Street TB45 & TB52 LTE ratings and 3891 336 ACSR (0.59 miles) from P. 3891/63 to P. 3891/51. Isolated 3154. All Load restored in 5 load block transfers
Bridge Street	G192		14.0	Isolated load can be reduced to 7.9 MW after 4 load block transfers. Bridge Street TB15C would remain isolated
Bridge Street	TB15C	13/15	7.9	No SCADA switching on the Nashua 4 kV
Lawrence Road	TB48	178/201	2.1	Limited by Hudson transformers, Hudson 389 pick-up setting, 389 477 ACSR from Hudson to Edgeville Tap (1.94 miles), 3128R1 pick-up setting and 3128 336 ACSR from Mammoth Road to 4/44 (1.24 miles)
Long Hill	TB10, TB20	53/62, 56/62	0.0	STE violation. Load exceeds STE by 8.3 MVA. No switching is possible to offload this station

Western Region

Western Region - Base Case Violations (2024)					
Transformer Violations					
Substation	XFMR	XFMR Rating (MVA)	Loading (MW/MVA)	(%)	Notes
<i>No violations identified.</i>					
Circuit Violations					
Substation	Circuit	Line Rating (MVA)	Loading (MW/MVA)	(%)	Notes
North Keene	76W1				Court Street<0.975 (0.956 PU)

Western Region – Contingency Violations (2024)				
Substation	XFMR or T Line	LTE/STE XFMR Rating (MVA)	Isolated Load (MW)	Notes
Chestnut Hill	TB87, TB98	16/18, 16/18	4.1	Limited by LTE rating of the remaining Chestnut transformer at 107% LTE

2025

Assumptions

All scheduled construction prior to June 1, 2025 is complete.

- Coheco Street (Dover) Substation transformers have been upgraded and bus tie has been installed.
- Ashland Substation 44.8 MVA second transformer has been added and bus tie has been installed with automation of the circuit tie outside the station.

General Discussion

For 2025, the following new planning criteria violations were identified:

- 0 transformers exceed 95% base case nameplate loading
- 1 circuit exceeds 100% base case normal loading
- 0 circuits have steady-state voltage that is less than 0.975 per unit
- 1 substation has a new N-1 contingency violation

Any new planning criteria violations are presented in bold within the following tables.

Suggested Projects

The following projects are suggested to address violations. This is a partial list of solution options as some violations require a local study to be performed to determine a feasible solution. The projects proposed here require additional study to determine if they are the optimal solution for the violation identified. Solution options noted in earlier years of study are not included.

Base Case Solution Options

- North Keene 76W1
 - Reconductor 1.89 miles of 4/0 ACSR between p.76W1/21Y and p.192/53.

N-1 Contingency Solution Options

- Loss of Bridge Street TB45 or TB25 (STE Violation)
 - Transfer load to Thornton substation to reduce loading below minimum STE rating.

Central Region

Central Region - Base Case Violations (2025)					
Transformer Violations					
Substation	XFMR	XFMR Rating (MVA)	Loading (MW/MVA)	(%)	Notes
<i>No violations identified.</i>					
Circuit Violations					
Substation	Circuit	Line Rating (MVA)	Loading (MW/MVA)	(%)	Notes
<i>No violations identified.</i>					

Central Region - Contingency Violations (2025)				
Substation	XFMR or T Line	LTE/STE XFMR Rating (MVA)	Isolated Load (MW)	Notes
Eddy	TB26, TB81	54/61, 56/62	0.0	STE violation. Load exceeds STE by 10.2 MVA. No switching is possible to offload this station
Huse Rd	TB46, TB58	58/69, 56/62	0.0	STE violation. Load exceeds STE by 16 MVA. No switching is possible to offload this station
Pine Hill	TB118, TB161	54/66, 55/59	0.0	STE violation. Load exceeds STE by 0.6 MVA. No switching is possible to offload this station

Eastern Region

Eastern Region - Base Case Violations (2025)					
Transformer Violations					
Substation	XFMR	XFMR Rating (MVA)	Loading (MW/MVA)	(%)	Notes
Great Bay	TB141	44.8	43.5/43.7	99%	Unitil to offload more load to Timber Swamp
Circuit Violations					
Substation	Circuit	Line Rating (MVA)	Loading (MW/MVA)	(%)	Notes
<i>No violations identified.</i>					

Eastern Region – Contingency Violations (2025)				
Substation	XFMR or T Line	LTE/STE XFMR Rating (MVA)	Isolated Load (MW)	Notes
Madbury	TB65, TB74	56/62, 54/64	0	STE violation. Load exceeds STE by 17.2 MVA. Load can be transferred to Brentwood and Ocean Rd substations
Rochester	TB53, TB57	56/61, 56/67	0	STE Violation. Load exceeded STE by 3.1 MVA. Load can be transferred to Dover substation

Northern Region

Northern Region - Base Case Violations (2025)					
Transformer Violations					
Substation	XFMR	XFMR Rating (MVA)	Loading (MW/MVA)	(%)	Notes
<i>No violations identified.</i>					
Circuit Violations					
Substation	Circuit	Line Rating (MVA)	Loading (MW/MVA)	(%)	Notes
<i>No violations identified.</i>					

Northern Region – Contingency Violations (2025)				
Substation	XFMR or T Line	LTE/STE XFMR Rating (MVA)	Isolated Load (MW)	Notes
North Woodstock	TB67	54/64	11.1	Requires system upgrades on NHEC's system to utilize Thornton-North Woodstock circuit tie
Laconia	TB24, TB125	48/62, 54/66	0.0	STE violation. Load exceeds STE by 4.4 MVA. Load can be transferred to Daniel substation

Southern Region

Southern Region - Base Case Violations (2025)					
Transformer Violations					
Substation	XFMR	XFMR Rating (MVA)	Loading (MW/MVA)	(%)	Notes
<i>No violations identified.</i>					
Circuit Violations					
Substation	Circuit	Line Rating (MVA)	Loading (MW/MVA)	(%)	Notes
Scobie	32W4				Kendall Pond voltage<0.975 (.96 PU)

Southern Region – Contingency Violations (2025)				
Substation	XFMR or T Line	LTE/STE XFMR Rating (MVA)	Isolated Load (MW)	Notes
Scobie Pond	N124		24.9	Minimum exposure due to its short length and to being entirely contained within the Scobie Pond Substation property
Long Hill	P134		17.5	Limited by Bridge Street TB45 & TB52 LTE ratings and 3891 336 ACSR (0.59 miles) from P. 3891/63 to P. 3891/51. Isolated 3154. All Load restored in 5 load block transfers
Bridge Street	G192		14.0	Isolated load can be reduced to 7.9 MW after 4 load block transfers. Bridge Street TB15C would remain isolated
Bridge Street	TB15C	13/15	7.9	No SCADA switching on the Nashua 4 kV
Lawrence Road	TB48	178/201	2.1	Limited by Hudson transformers, Hudson 389 pick-up setting, 389 477 ACSR from Hudson to Edgeville Tap (1.94 miles), 3128R1 pick-up setting and 3128 336 ACSR from Mammoth Road to 4/44 (1.24 miles)
Long Hill	TB10, TB20	53/62, 56/62	0.0	STE violation. Load exceeds STE by 8.5 MVA. No switching is possible to offload this station
Bridge Street	TB45, TB25	51/57, 51/57	0.0	STE violation. Load exceeds STE by 0.1 MVA. Load can be transferred to Thornton substation

New violations for this year are presented in bold.

Western Region

Western Region - Base Case Violations (2025)					
Transformer Violations					
Substation	XFMR	XFMR Rating (MVA)	Loading (MW/MVA)	(%)	Notes
<i>No violations identified.</i>					
Circuit Violations					
Substation	Circuit	Line Rating (MVA)	Loading (MW/MVA)	(%)	Notes
North Keene	76W1	8.5	8.4/8.5	100%	1.89 Miles 4/0 ACSR P. 76W1/21Y - P. 192/53
North Keene	76W1				Court Street<0.975 (0.955 PU)

Western Region – Contingency Violations (2025)				
Substation	XFMR or T Line	LTE/STE XFMR Rating (MVA)	Isolated Load (MW)	Notes
Chestnut Hill	TB87, TB98	16/18, 16/18	4.1	Limited by LTE rating of the remaining Chestnut transformer at 108% LTE.

New violations for this year are presented in bold.

2029

Assumptions

All scheduled construction prior to June 1, 2029 is complete.

- Chestnut Hill Substation transformers have been upgraded with automation of the circuit tie outside the station (2026).
- Long Hill Substation transformers have been upgraded and bus tie has been installed (2027).

General Discussion

For 2029, the following new planning criteria violations were identified:

- 0 transformers exceed 95% base case nameplate loading
- 0 circuits exceed 100% base case normal loading
- 0 circuits have steady-state voltage that is less than 0.975 per unit
- 2 substations have new N-1 contingency violations

Any new planning criteria violations are presented in bold within the following tables.

Suggested Projects

The following projects are suggested to address violations. This is a partial list of solution options as some violations require a local study to be performed to determine a feasible solution. The projects proposed here require additional study to determine if they are the optimal solution for the violation identified. Solution options noted in earlier years of study are not included.

N-1 Contingency Solution Options

- Loss of Bedford TB164 or TB191 (STE violation)
 - No switching is possible to offload this station. Transformer upgrade is recommended.
- Loss of Oak Hill TB15 or TB84 (STE violation)
 - Transfer load to Garvins substation via Unitil switching to reduce loading below minimum STE rating.

Central Region

Central Region - Base Case Violations (2029)					
Transformer Violations					
Substation	XFMR	XFMR Rating (MVA)	Loading (MW/MVA)	(%)	Notes
<i>No violations identified.</i>					
Circuit Violations					
Substation	Circuit	Line Rating (MVA)	Loading (MW/MVA)	(%)	Notes
<i>No violations identified.</i>					

Central Region - Contingency Violations (2029)				
Substation	XFMR or T Line	LTE/STE XFMR Rating (MVA)	Isolated Load (MW)	Notes
Bedford	TB164, TB191	54/64, 54/65	0.0	STE violation. Load exceeds STE by 0.6 MVA. No switching is possible to offload this station
Eddy	TB26, TB81	54/61, 56/62	0.0	STE violation. Load exceeds STE by 11.1 MVA. No switching is possible to offload this station
Huse Rd	TB46, TB58	58/69, 56/62	0.0	STE violation. Load exceeds STE by 17.1 MVA. No switching is possible to offload this station
Oak Hill	TB15, TB84	55/67, 51/66	0.0	STE violation. Load exceeds STE by 0.4 MVA. Load can be transferred to Garvins via Unitil switching
Pine Hill	TB118, TB161	54/66, 55/59	0.0	STE violation. Load exceeds STE by 1.4 MVA. No switching is possible to offload this station

New violations for this year are presented in bold.

Eastern Region

Eastern Region - Base Case Violations (2029)					
Transformer Violations					
Substation	XFMR	XFMR Rating (MVA)	Loading (MW/MVA)	(%)	Notes
Great Bay	TB141	44.8	45.1/45.2	103%	Unitil to offload more load to Timber Swamp
Circuit Violations					
Substation	Circuit	Line Rating (MVA)	Loading (MW/MVA)	(%)	Notes
<i>No violations identified.</i>					

Eastern Region – Contingency Violations (2029)				
Substation	XFMR or T Line	LTE/STE XFMR Rating (MVA)	Isolated Load (MW)	Notes
Madbury	TB65, TB74	56/62, 54/64	0	STE violation. Load exceeds STE by 17.4 MVA. Load can be transferred to Brentwood and Ocean Rd substations
Rochester	TB53, TB57	56/61, 56/67	0	STE Violation. Load exceeded STE by 3.7 MVA. Load can be transferred to Dover substation

Northern Region

Northern Region - Base Case Violations (2029)					
Transformer Violations					
Substation	XFMR	XFMR Rating (MVA)	Loading (MW/MVA)	(%)	Notes
<i>No violations identified.</i>					
Circuit Violations					
Substation	Circuit	Line Rating (MVA)	Loading (MW/MVA)	(%)	Notes
<i>No violations identified.</i>					

Northern Region – Contingency Violations (2029)				
Substation	XFMR or T Line	LTE/STE XFMR Rating (MVA)	Isolated Load (MW)	Notes
North Woodstock	TB67	54/64	11.5	Requires system upgrades on NHEC's system to utilize Thornton-North Woodstock circuit tie
Laconia	TB24, TB125	48/62, 54/66	0.0	STE violation. Load exceeds STE by 5.5 MVA. Load can be transferred to Daniel substation

Southern Region

Southern Region - Base Case Violations (2029)					
Transformer Violations					
Substation	XFMR	XFMR Rating (MVA)	Loading (MW/MVA)	(%)	Notes
<i>No violations identified.</i>					
Circuit Violations					
Substation	Circuit	Line Rating (MVA)	Loading (MW/MVA)	(%)	Notes
Scobie	32W4				Kendall Pond voltage<0.975 (0.958 PU)

Southern Region – Contingency Violations (2029)				
Substation	XFMR or T Line	LTE/STE XFMR Rating (MVA)	Isolated Load (MW)	Notes
Scobie Pond	N124		24.9	Minimum exposure due to its short length and to being entirely contained within the Scobie Pond Substation property
Long Hill	P134		17.9	Limited by Bridge Street TB45 & TB52 LTE ratings and 3891 336 ACSR (0.59 miles) from P. 3891/63 to P. 3891/51. Isolated 3154. All Load restored in 5 load block transfers
Bridge Street	G192		14.2	Isolated load can be reduced to 8 MW after 4 load block transfers. Bridge Street TB15C would remain isolated
Bridge Street	TB15C	13/15	8.0	No SCADA switching on the Nashua 4 kV
Lawrence Road	TB48	178/201	2.1	Limited by Hudson transformers, Hudson 389 pick-up setting, 389 477 ACSR from Hudson to Edgeville Tap (1.94 miles), 3128R1 pick-up setting and 3128 336 ACSR from Mammoth Road to 4/44 (1.24 miles)
Bridge Street	TB45, TB25	51/57, 51/57	0.0	STE violation. Load exceeds STE by 0.7 MVA. Load can be transferred to Thornton substation

Western Region

Western Region - Base Case Violations (2029)					
Transformer Violations					
Substation	XFMR	XFMR Rating (MVA)	Loading (MW/MVA)	(%)	Notes
<i>No violations identified.</i>					
Circuit Violations					
Substation	Circuit	Line Rating (MVA)	Loading (MW/MVA)	(%)	Notes
North Keene	76W1	8.5	8.6/8.7	103%	1.89 Miles 4/0 ACSR P. 76W1/21Y - P. 192/53
North Keene	76W1				Court Street<0.975 (0.954 PU)

Western Region – Contingency Violations (2029)				
Substation	XFMR or T Line	LTE/STE XFMR Rating (MVA)	Isolated Load (MW)	Notes
<i>No violations identified.</i>				

Bulk Feeder Contingency Study

The following chapter is a year-by-year review of bulk substation feeder faults. The information presented here is to gain an understanding of where customer risk is the highest for a feeder fault.

The following system constraints were determined based on the following criteria:

	N-1 Contingency
Transformer Loading	> 100% LTE
Line Loading	> 100% emergency
Voltage, Unregulated Load	< 95%
Voltage, Regulated Load	< 92.5%
Load Block Transfer Limit	3
Remaining Isolated Load	> 0 MW

For distribution feeder contingency scenarios, this represents a breaker failure or line fault close to the substation. Anticipating that the first “zone” contains the fault, circuit ties between the feeder breaker and the first backbone device were excluded from the restoration steps.

Definitions:

- Regulated Load** Load that has voltage regulation at a 34.5kV primary voltage beyond the Bulk Distribution Facility. The system load is all beyond a PSNH voltage regulated source (line regulator on a tap or non-bulk substation LTC). Primary metered customers are considered regulated load because regulation is their responsibility in accordance with the Tariff.
- Unregulated Load** Load that has no voltage regulation at the 34.5 kV primary voltage beyond a Bulk Distribution Facility. The voltage of the system load is not regulated beyond the 34.5 kV point modeled for planning by System Planning and Strategy.

2020

General Discussion

For 2020, the following feeder breaker/line fault events that may impact customer reliability were identified:

- 40 breaker/line fault events

Suggested Projects

The following projects are suggested to address breaker failure/line faults that may impact customer reliability. This is a partial list of solution options as some scenarios require a local study to be performed to determine a feasible solution. The projects proposed here require additional study to determine if they are the optimal solution for the contingency identified.

Contingencies Solution Options

- Loss of Chester 3115X
 - Reconductor 2.97 miles of 2/0 CU from p. 377/188 to p.377/229. Study how to address overload of Prescott Road 333A regulators.
- Loss of Huse Road 393
 - Reconductor 2.13 miles of 266 ACSR from p.3614/66 to p.3614/130.
- Loss of Laconia 310
 - A newly constructed circuit tie with the 345 line addresses this scenario once operational.
- Loss of Mill Pond 71W1
 - Install a SCADA controlled device at the 1W1DX1W4.
- Loss of Mill Pond 71W3
 - Install a SCADA controlled sectionalizing device at the 71W4J34.
- Loss of Mill Pond 71W4
 - Install a SCADA controlled sectionalizing device at the 71W3DX66.
- Loss of North Keene 76W7
 - Install a SCADA controlled device at 76W1DX2 or JW7W3.
- Loss of North Road 316
 - Install a 1.8 MVAR capacitor near George's Mill Tap.
- Loss of Oak Hill 319
 - Reconductor 3 miles from Madbury Substation to Lee Traffic Circle with 795 Spacer Cable.
 - Reconductor 7.9 miles from Northwood Narrows to Ingalls Rd with 336 Spacer Cable.
 - Replace Ingalls Rd Regulators with 335 Amps regulators.
 - Install 5.4 MVAR of capacitance support on the 3137X line.
- Loss of South Milford 378
 - Program 322X12 recloser with load encroachment.
- Loss of Weare 3108
 - Install a SCADA controlled device at the 3108DX2.

Central Region

Central Region – Contingencies with Risk of Isolated Customers (2020)				
Substation	D Line	Served Load (MW)	Isolated Load (MW)	Notes
Pine Hill	3613	11.0	11.0	Manual Sectionalizing device. Circuit tie is within the first line section
Oak Hill	319	19.4	10.9	Limited by Ingalls Rd Regulators (14.1 MW emergency rating), 336 AL Spacer Madbury-Lee Traffic Circle (3 miles), 336 ACSR Lee Traffic Circle-Northwood Narrows (15.9 miles), 266 ACSR Northwood Narrows- Ingalls Rd (7.9 miles) and low voltage on 319 and 3137X lines
Weare	3108	6.8	6.8	Limited by manual device (3108DX2)
Canal Street	364	5.1	5.1	Limited by manual device (J9064)
Huse Road	393	20.9	4.3	Limited by 2.13 miles of 266 ACSR from P. 3614/66 (3614J35 Mammoth Road RTU) to P. 3614/130 (393J6 Hanover St). Recommend reconductoring 3614
Huse Road	3119	3.7	3.7	Radial line
South State Street	3190	1.4	1.4	Limited by manual device (J9064)

Eastern Region

Eastern Region – Contingencies with Risk of Isolated Customers (2020)				
Substation	D Line	Served Load (MW)	Isolated Load (MW)	Notes
Mill Pond	71W4	4.8	4.8	Limited by a manual sectionalizing device (71W4J34)
Mill Pond	71W3	4.4	4.4	Limited by a manual sectionalizing device (71W3DX66)
Mill Pond	71W1	2.8	2.8	Limited by manual device (1W1DX1W4) and Cutts St 15W4 XFMR overload

Northern Region

Northern Region - Contingencies with Risk of Isolated Customers (2020)				
Substation	D Line	Served Load (MW)	Isolated Load (MW)	Notes
Laconia	310	19.2	19.2	310-345X5 would allow for a complete restoration once operational by Fall 2020
Laconia	368	19.9	15.3	Limited by mobile TX106 overload
Whitefield	348	15.2	15.2	Radial line
White Lake	3116X	20.3	14.5	Limited by White Lake 346 line 7.95 Miles of 336 ACSR from White Lake to 346X1 at P.346/605 at 114% Emergency. Isolated Wolfeboro Municipal
Ashland	338	29.3	13.5	Limited by the mobile & White Lake XFMRs overload, voltage on 338 line and 345 line overload 3.73 miles of 336 ACSR from Pemi breaker to 345X2 TAP at 99% Emergency. Isolated NHEC Moultonboro. Cap bank installation at Straits Rd and line reconductoring are recommended with the new Pemi XFMR
Pemigewasset	3114X	12.6	12.6	Radial Line
Lost Nation	355X	9.5	9.5	Radial Line
Saco Valley	395	8.7	8.7	Radial line. NHEC can restore its own load (6.9 MW)
North Woodstock	3822	8.4	8.4	Requires system upgrades on NHEC's system to utilize Thornton-North Woodstock circuit tie
Beebe River	342B	8.0	8.0	Manual circuit tie to NHEC. Eversource circuit tie within the first section of the 342A
Laconia	3222X	7.2	7.2	Radial line. SCADA controlled tie within the first section
Beebe River	342A	12.3	6.9	Limited by Ashland transformer overload
Webster	3193	6.0	6.0	Radial line feeding NHEC Webster
White Lake	346	28.1	5.5	Limited by White Lake 3116X line 6.78 Miles of 336 ACSR from White Lake to J9016 at P.390/307 at 114% emergency rating. Isolated NHEC Tuftonboro
North Woodstock	3126	2.4	2.4	Requires system upgrades on NHEC's system to utilize Thornton-North Woodstock circuit tie
Lost Nation	384	0.6	0.6	Radial Line

Southern Region

Southern Region – Contingencies with Risk of Isolated Customers (2020)				
Substation	D Line	Served Load (MW)	Isolated Load (MW)	Notes
Chester	3115X	28.9	8.9	Limited by 2.97 miles of 2/0 CU from P. 377/188 to 377/229 and Prescott Road 333A regulators (120% LTE). Recommended to reconductor and upgrade regulators. Isolated NHEC Chester
South Milford	378	21.8	6.0	Limited by South Milford TB86 LTE rating, 314X12 335A regulator at West Milford and 322X12 recloser pick-up rating. Recommend programming load encroachment. Isolates Milford Substation and portion of 23X6
Lawrence Road	3133X	19.2	3.7	Limited by 3128R1 pick-up setting and 3128 336 ACSR from Mammoth Road to P. 4/44 (1.24 miles)

Western Region

Western Region – Contingencies with Risk of Isolated Customers (2020)				
Substation	D Line	Served Load (MW)	Isolated Load (MW)	Notes
North Road	315	14.4	14.4	Circuit tie is within the first line section of the 315. To be resolved by the new 315-3410X1 circuit tie planned for Fall 2020
Chestnut Hill	3178	10.1	10.1	Radial Line
Emerald Street	W9	8.8	8.8	Circuit tie is within the first line section of the W9. Limited by W9 W9R1 pick-up setting
North Keene	76W7	6.2	6.2	Manual circuit tie. Limited by 76W1 4/0 ACSR from North Keene to 192/92 (1.04 miles)
Chestnut Hill	3139	6.2	6.2	Radial Line
North Road	3180	3.9	3.9	Manual circuit tie. Circuit tie is within the first line section of the 3180
Newport	42X3	3.8	3.8	Radial line
Emerald Street	W15	2.9	2.9	Circuit tie is within the first line section of W15. Limited by Emerald Street W185 pick-up setting
Emerald Street	W1	2.4	2.4	Circuit tie is within the first line section of the W1. Limited by 76W1 76W1FX52 at 192/52 and 76W1 4/0 ACSR from North Keene to 192/54 (1.81 miles)
Emerald Street	W185	5.9	2.3	Circuit tie is within the first line section of the W185. Limited by Emerald Street W15 pick-up setting
North Road	316	16.7	2.0	Limited by low voltage on the 316 line. Solved with 1.8 MVAR Cap bank at George Mill Tap

2021

For 2021, the following new feeder breaker/line fault events that may impact customer reliability were identified:

- 0 breaker/line fault events

Any new events are presented in bold within the following tables.

Central Region

Central Region – Contingencies with Risk of Isolated Customers (2021)				
Substation	D Line	Served Load (MW)	Isolated Load (MW)	Notes
Pine Hill	3613	11.1	11.1	Manual Sectionalizing device. Circuit tie is within the first line section
Oak Hill	319	19.6	11.1	Limited by Ingalls Rd Regulators (14.1 MW emergency rating), 336 AL Spacer Madbury-Lee Traffic Circle (3 miles), 336 ACSR Lee Traffic Circle-Northwood Narrows (15.9 miles), 266 ACSR Northwood Narrows- Ingalls Rd (7.9 miles) and low voltage on 319 and 3137X lines
Weare	3108	6.8	6.8	Limited by manual device (3108DX2)
Canal Street	364	5.1	5.1	Limited by manual device (J9064)
Huse Road	393	21	4.3	Limited by 2.13 miles of 266 ACSR from P. 3614/66 (3614J35 Mammoth Road RTU) to P. 3614/130 (393J6 Hanover St). Recommend reconductoring 3614
Huse Road	3119	3.8	3.8	Radial line
South State Street	3190	1.4	1.4	Limited by manual device (J9064)

Eastern Region

Eastern Region – Contingencies with Risk of Isolated Customers (2021)				
Substation	D Line	Served Load (MW)	Isolated Load (MW)	Notes
Mill Pond	71W4	4.8	4.8	Limited by a manual sectionalizing device (71W4J34)
Mill Pond	71W3	4.5	4.5	Limited by a manual sectionalizing device (71W3DX66)
Mill Pond	71W1	3.3	3.3	Limited by manual device (1W1DX1W4) and Cutts St 15W4 XFMR overload

Northern Region

Northern Region – Contingencies with Risk of Isolated Customers (2021)				
Substation	D Line	Served Load (MW)	Isolated Load (MW)	Notes
Whitefield	348	15.3	15.3	Radial line
White Lake	3116X	20.3	14.5	Limited by White Lake 346 line 7.95 Miles of 336 ACSR from White Lake to 346X1 at P.346/605 at 114% Emergency. Isolated Wolfeboro Municipal
Pemigewasset	3114X	12.7	12.7	Radial Line
Lost Nation	355X	9.6	9.6	Radial Line
Saco Valley	395	9.3	9.3	Radial line. NHEC can restore its own load (7.3 MW)
North Woodstock	3822	8.5	8.5	Requires system upgrades on NHEC's system to utilize Thornton-North Woodstock circuit tie
Ashland	338	29.6	8.4	Requires load cascading. Limited by White Lake XFMRs overload, voltage on 338 line. Without cascading, 345 line (3.73 miles of 336 ACSR from Pemi breaker to 345X2 Tap) would be at 110% emergency rating. Isolated NHEC Moultonboro. Cap bank installation at Straits Rd and line reconductoring are recommended
Beebe River	342B	8.1	8.1	Manual circuit tie to NHEC. Eversource circuit tie within the first section of the 342A
Laconia	3222X	7.3	7.3	Radial line. SCADA controlled tie within the first section
Beebe River	342A	12.4	7.0	Limited by Ashland transformer overload
Webster	3193	6	6.0	Radial line feeding NHEC Webster
White Lake	346	28.4	5.6	Limited by White Lake 3116X line 6.78 Miles of 336 ACSR from White Lake to J9016 at P.390/307 at 114% emergency rating. Isolated NHEC Tuftonboro
North Woodstock	3126	2.4	2.4	Requires system upgrades on NHEC's system to utilize Thornton-North Woodstock circuit tie
Lost Nation	384	0.6	0.6	Radial Line

Southern Region

Southern Region - Contingencies with Risk of Isolated Customers (2021)				
Substation	D Line	Served Load (MW)	Isolated Load (MW)	Notes
Chester	3115X	28.9	8.9	Limited by 2.97 miles of 2/0 CU from P. 377/188 to 377/229 and Prescott Road 333A regulators (120% LTE). Recommended to reconductor and upgrade regulators. Isolated NHEC Chester
South Milford	378	22	6.2	Limited by South Milford TB86 LTE rating, 314X12 335A regulator at West Milford and 322X12 recloser pick-up rating. Recommend programming load encroachment. Isolates Milford Substation and portion of 23X6
Lawrence Road	3133X	19.3	3.8	Limited by 3128R1 pick-up setting and 3128 336 ACSR from Mammoth Road to P. 4/44 (1.24 miles)

Western Region

Western Region - Contingencies with Risk of Isolated Customers (2021)				
Substation	D Line	Served Load (MW)	Isolated Load (MW)	Notes
Chestnut Hill	3178	10.2	10.2	Radial Line
Emerald Street	W9	9.4	9.4	Circuit tie is within the first line section of the W9. Limited by W9 W9R1 pick-up setting
North Keene	76W7	6.3	6.3	Manual circuit tie. Limited by 76W1 4/0 ACSR from North Keene to 192/92 (1.04 miles)
Chestnut Hill	3139	6.2	6.2	Radial Line
North Road	3180	3.9	3.9	Manual circuit tie. Circuit tie is within the first line section of the 3180
Newport	42X3	3.8	3.8	Radial line
Emerald Street	W15	2.9	2.9	Circuit tie is within the first line section of W15. Limited by Emerald Street W185 pick-up setting
Emerald Street	W1	2.4	2.4	Circuit tie is within the first line section of the W1. Limited by 76W1 76W1FX52 at 192/52 and 76W1 4/0 ACSR from North Keene to 192/54 (1.81 miles)
Emerald Street	W185	5.9	2.3	Circuit tie is within the first line section of the W185. Limited by Emerald Street W15 pick-up setting
North Road	316	16.8	2.0	Limited by low voltage on the 316 line. Solved with 1.8 MVAR Cap bank at George Mill Tap

2022

For 2022, the following new feeder breaker/line fault events that may impact customer reliability were identified:

- 0 breaker/line fault events

Any new events are presented in bold within the following tables.

Central Region

Central Region – Contingencies with Risk of Isolated Customers (2022)				
Substation	D Line	Served Load (MW)	Isolated Load (MW)	Notes
Pine Hill	3613	11.1	11.1	Manual Sectionalizing device. Circuit tie is within the first line section
Oak Hill	319	19.7	11.1	Limited by Ingalls Rd Regulators (14.1 MW emergency rating), 336 AL Spacer Madbury-Lee Traffic Circle (3 miles), 336 ACSR Lee Traffic Circle-Northwood Narrows (15.9 miles), 266 ACSR Northwood Narrows- Ingalls Rd (7.9 miles) and low voltage on 319 and 3137X lines
Weare	3108	6.9	6.9	Limited by manual device (3108DX2)
Canal Street	364	5.1	5.1	Limited by manual device (J9064)
Huse Road	393	21.1	4.3	Limited by 2.13 miles of 266 ACSR from P. 3614/66 (3614J35 Mammoth Road RTU) to P. 3614/130 (393J6 Hanover St). Recommend reconductoring 3614
Huse Road	3119	3.8	3.8	Radial line
South State Street	3190	1.4	1.4	Limited by manual device (J9064)

Eastern Region

Eastern Region – Contingencies with Risk of Isolated Customers (2022)				
Substation	D Line	Served Load (MW)	Isolated Load (MW)	Notes
Mill Pond	71W4	4.8	4.8	Limited by a manual sectionalizing device (71W4J34)
Mill Pond	71W3	4.5	4.5	Limited by a manual sectionalizing device (71W3DX66)
Mill Pond	71W1	3.4	3.4	Limited by manual device (1W1DX1W4) and Cutts St 15W4 XFMR overload

Northern Region

Northern Region – Contingencies with Risk of Isolated Customers (2022)				
Substation	D Line	Served Load (MW)	Isolated Load (MW)	Notes
Whitefield	348	15.4	15.4	Radial line
White Lake	3116X	20.4	14.5	Limited by White Lake 346 line 7.95 Miles of 336 ACSR from White Lake to 346X1 at P.346/605 at 114% Emergency. Isolated Wolfeboro Municipal
Pemigewasset	3114X	12.8	12.8	Radial Line
Lost Nation	355X	9.6	9.6	Radial Line
Saco Valley	395	9.3	9.3	Radial line. NHEC can restore its own load (7.3 MW)
North Woodstock	3822	8.6	8.5	Requires system upgrades on NHEC's system to utilize Thornton-North Woodstock circuit tie
Ashland	338	29.6	8.4	Requires load cascading. Limited by White Lake XFMRs overload, voltage on 338 line. Without cascading, 345 line (3.73 miles of 336 ACSR from Pemi breaker to 345X2 Tap) would be at 110% emergency rating. Isolated NHEC Moultonboro. Cap bank installation at Straits Rd and line reconductoring are recommended
Beebe River	342B	8.1	8.1	Manual circuit tie to NHEC. Eversource circuit tie within the first section of the 342A
Laconia	3222X	7.3	7.3	Radial line. SCADA controlled tie within the first section
Beebe River	342A	12.5	7.1	Limited by Ashland transformer overload
Webster	3193	6.1	6.1	Radial line feeding NHEC Webster
White Lake	346	28.6	5.6	Limited by White Lake 3116X line 6.78 Miles of 336 ACSR from White Lake to J9016 at P.390/307 at 114% emergency rating. Isolated NHEC Tuftonboro
North Woodstock	3126	2.4	2.4	Requires system upgrades on NHEC's system to utilize Thornton-North Woodstock circuit tie
Lost Nation	384	0.6	0.6	Radial Line

Southern Region

Southern Region – Contingencies with Risk of Isolated Customers (2022)				
Substation	D Line	Served Load (MW)	Isolated Load (MW)	Notes
Chester	3115X	29.1	9	Limited by 2.97 miles of 2/0 CU from P. 377/188 to 377/229 and Prescott Road 333A regulators (120% LTE). Recommended to reconductor and upgrade regulators. Isolated NHEC Chester
South Milford	378	22	6.2	Limited by South Milford TB86 LTE rating, 314X12 335A regulator at West Milford and 322X12 recloser pick-up rating. Recommend programming load encroachment. Isolates Milford Substation and portion of 23X6
Lawrence Road	3133X	19.3	3.8	Limited by 3128R1 pick-up setting and 3128 336 ACSR from Mammoth Road to P. 4/44 (1.24 miles)

Western Region

Western Region - Contingencies with Risk of Isolated Customers (2022)				
Substation	D Line	Served Load (MW)	Isolated Load (MW)	Notes
Chestnut Hill	3178	10.2	10.2	Radial Line
Emerald Street	W9	9.4	9.4	Circuit tie is within the first line section of the W9. Limited by W9 W9R1 pick-up setting
North Keene	76W7	6.3	6.3	Manual circuit tie. Limited by 76W1 4/0 ACSR from North Keene to 192/92 (1.04 miles)
Chestnut Hill	3139	6.2	6.2	Radial Line
North Road	3180	3.9	3.9	Manual circuit tie. Circuit tie is within the first line section of the 3180
Newport	42X3	3.8	3.8	Radial line
Emerald Street	W15	2.9	2.9	Circuit tie is within the first line section of W15. Limited by Emerald Street W185 pick-up setting
Emerald Street	W1	2.4	2.4	Circuit tie is within the first line section of the W1. Limited by 76W1 76W1FX52 at 192/52 and 76W1 4/0 ACSR from North Keene to 192/54 (1.81 miles)
Emerald Street	W185	6	2.3	Circuit tie is within the first line section of the W185. Limited by Emerald Street W15 pick-up setting
North Road	316	16.8	2.0	Limited by low voltage on the 316 line. Solved with 1.8 MVAR Cap bank at George Mill Tap

2023

For 2023, the following new feeder breaker/line fault events that may impact customer reliability were identified:

- 0 breaker/line fault events

Any new events are presented in bold within the following tables.

Central Region

Central Region – Contingencies with Risk of Isolated Customers (2023)				
Substation	D Line	Served Load (MW)	Isolated Load (MW)	Notes
Pine Hill	3613	11.1	11.1	Manual Sectionalizing device. Circuit tie is within the first line section
Oak Hill	319	19.7	11.1	Limited by Ingalls Rd Regulators (14.1 MW emergency rating), 336 AL Spacer Madbury-Lee Traffic Circle (3 miles), 336 ACSR Lee Traffic Circle-Northwood Narrows (15.9 miles), 266 ACSR Northwood Narrows- Ingalls Rd (7.9 miles) and low voltage on 319 and 3137X lines
Weare	3108	6.9	6.9	Limited by manual device (3108DX2)
Canal Street	364	5.1	5.1	Limited by manual device (J9064)
Huse Road	393	21.1	4.3	Limited by 2.13 miles of 266 ACSR from P. 3614/66 (3614J35 Mammoth Road RTU) to P. 3614/130 (393J6 Hanover St). Recommend reconductoring 3614
Huse Road	3119	3.8	3.8	Radial line
South State Street	3190	1.4	1.4	Limited by manual device (J9064)

Eastern Region

Eastern Region – Contingencies with Risk of Isolated Customers (2023)				
Substation	D Line	Served Load (MW)	Isolated Load (MW)	Notes
Mill Pond	71W4	4.8	4.8	Limited by a manual sectionalizing device (71W4J34)
Mill Pond	71W3	4.5	4.5	Limited by a manual sectionalizing device (71W3DX66)
Mill Pond	71W1	3.4	3.4	Limited by manual device (1W1DX1W4) and Cutts St 15W4 XFMR overload

Northern Region

Northern Region – Contingencies with Risk of Isolated Customers (2023)				
Substation	D Line	Served Load (MW)	Isolated Load (MW)	Notes
Whitefield	348	15.4	15.4	Radial line
White Lake	3116X	20.4	14.5	Limited by White Lake 346 line 7.95 Miles of 336 ACSR from White Lake to 346X1 at P.346/605 at 114% Emergency. Isolated Wolfeboro Municipal
Pemigewasset	3114X	12.9	12.9	Radial Line
Lost Nation	355X	9.7	9.7	Radial Line
Saco Valley	395	9.3	9.3	Radial line. NHEC can restore its own load (7.4 MW)
North Woodstock	3822	8.6	8.6	Requires system upgrades on NHEC's system to utilize Thornton-North Woodstock circuit tie
Ashland	338	29.6	8.4	Requires load cascading. Limited by White Lake XFMRs overload, voltage on 338 line. Without cascading, 345 line (3.73 miles of 336 ACSR from Pemi breaker to 345X2 Tap) would be at 110% emergency rating. Isolated NHEC Moultonboro. Cap bank installation at Straits Rd and line reconductoring are recommended
Beebe River	342B	8.1	8.1	Manual circuit tie to NHEC. Eversource circuit tie within the first section of the 342A
Laconia	3222X	7.3	7.3	Radial line. SCADA controlled tie within the first section
Beebe River	342A	12.5	7.1	Limited by Ashland transformer overload
Webster	3193	6.1	6.1	Radial line feeding NHEC Webster
White Lake	346	28.7	5.6	Limited by White Lake 3116X line 6.78 Miles of 336 ACSR from White Lake to J9016 at P.390/307 at 114% emergency rating. Isolated NHEC Tuftonboro
North Woodstock	3126	2.4	2.4	Requires system upgrades on NHEC's system to utilize Thornton-North Woodstock circuit tie
Lost Nation	384	0.6	0.6	Radial Line

Southern Region

Southern Region – Contingencies with Risk of Isolated Customers (2023)				
Substation	D Line	Served Load (MW)	Isolated Load (MW)	Notes
Chester	3115X	29.1	9.0	Limited by 2.97 miles of 2/0 CU from P. 377/188 to 377/229 and Prescott Road 333A regulators (120% LTE). Recommended to reconductor and upgrade regulators. Isolated NHEC Chester
South Milford	378	22.1	6.2	Limited by South Milford TB86 LTE rating, 314X12 335A regulator at West Milford and 322X12 recloser pick-up rating. Recommend programming load encroachment. Isolates Milford Substation and portion of 23X6
Lawrence Road	3133X	19.4	3.8	Limited by 3128R1 pick-up setting and 3128 336 ACSR from Mammoth Road to P. 4/44 (1.24 miles)

Western Region

Western Region – Contingencies with Risk of Isolated Customers (2023)				
Substation	D Line	Served Load (MW)	Isolated Load (MW)	Notes
Chestnut Hill	3178	10.3	10.3	Radial Line
Emerald Street	W9	9.4	9.4	Circuit tie is within the first line section of the W9. Limited by W9 W9R1 pick-up setting
North Keene	76W7	6.3	6.3	Manual circuit tie. Limited by 76W1 4/0 ACSR from North Keene to 192/92 (1.04 miles)
Chestnut Hill	3139	6.3	6.3	Radial Line
North Road	3180	3.9	3.9	Manual circuit tie. Circuit tie is within the first line section of the 3180
Newport	42X3	3.8	3.8	Radial line
Emerald Street	W15	2.9	2.9	Circuit tie is within the first line section of W15. Limited by Emerald Street W185 pick-up setting
Emerald Street	W1	2.4	2.4	Circuit tie is within the first line section of the W1. Limited by 76W1 76W1FX52 at 192/52 and 76W1 4/0 ACSR from North Keene to 192/54 (1.81 miles)
Emerald Street	W185	6	2.3	Circuit tie is within the first line section of the W185. Limited by Emerald Street W15 pick-up setting
North Road	316	16.9	2.0	Limited by low voltage on the 316 line. Solved with 1.8 MVAR Cap bank at George Mill Tap

2024

For 2024, the following new feeder breaker/line fault events that may impact customer reliability were identified:

- 0 breaker/line fault events

Any new events are presented in bold within the following tables.

Central Region

Central Region – Contingencies with Risk of Isolated Customers (2024)				
Substation	D Line	Served Load (MW)	Isolated Load (MW)	Notes
Pine Hill	3613	11.2	11.2	Manual Sectionalizing device. Circuit tie is within the first line section
Oak Hill	319	19.8	11.1	Limited by Ingalls Rd Regulators (14.1 MW emergency rating), 336 AL Spacer Madbury-Lee Traffic Circle (3 miles), 336 ACSR Lee Traffic Circle-Northwood Narrows (15.9 miles), 266 ACSR Northwood Narrows- Ingalls Rd (7.9 miles) and low voltage on 319 and 3137X lines
Weare	3108	6.9	6.9	Limited by manual device (3108DX2)
Canal Street	364	5.1	5.1	Limited by manual device (J9064)
Huse Road	393	21.2	4.3	Limited by 2.13 miles of 266 ACSR from P. 3614/66 (3614J35 Mammoth Road RTU) to P. 3614/130 (393J6 Hanover St). Recommend reconductoring 3614
Huse Road	3119	3.8	3.8	Radial line
South State Street	3190	1.4	1.4	Limited by manual device (J9064)

Eastern Region

Eastern Region – Contingencies with Risk of Isolated Customers (2024)				
Substation	D Line	Served Load (MW)	Isolated Load (MW)	Notes
<i>None identified.</i>				

Northern Region

Northern Region – Contingencies with Risk of Isolated Customers (2024)				
Substation	D Line	Served Load (MW)	Isolated Load (MW)	Notes
Whitefield	348	15.5	15.5	Radial line
White Lake	3116X	20.4	14.5	Limited by White Lake 346 line 7.95 Miles of 336 ACSR from White Lake to 346X1 at P.346/605 at 114% Emergency. Isolated Wolfeboro Municipal
Pemigewasset	3114X	13	13.0	Radial Line
Lost Nation	355X	9.7	9.7	Radial Line
Saco Valley	395	9.4	9.4	Radial line. NHEC can restore its own load (7.5 MW)
North Woodstock	3822	8.6	8.6	Requires system upgrades on NHEC's system to utilize Thornton-North Woodstock circuit tie
Ashland	338	29.8	8.4	Requires load cascading. Limited by White Lake XFMRs overload, voltage on 338 line. Without cascading, 345 line (3.73 miles of 336 ACSR from Pemi breaker to 345X2 Tap) would be at 110% emergency rating. Isolated NHEC Moultonboro. Cap bank installation at Straits Rd and line reconductoring are recommended
Beebe River	342B	8.2	8.2	Manual circuit tie to NHEC. Eversource circuit tie within the first section of the 342A
Laconia	3222X	7.3	7.3	Radial line. SCADA controlled tie within the first section
Beebe River	342A	12.6	7.2	Limited by Ashland transformer overload
Webster	3193	6.1	6.1	Radial line feeding NHEC Webster
White Lake	346	28.8	5.6	Limited by White Lake 3116X line 6.78 Miles of 336 ACSR from White Lake to J9016 at P.390/307 at 114% emergency rating. Isolated NHEC Tuftonboro
North Woodstock	3126	2.4	2.4	Requires system upgrades on NHEC's system to utilize Thornton-North Woodstock circuit tie
Lost Nation	384	0.6	0.6	Radial Line

Southern Region

Southern Region - Contingencies with Risk of Isolated Customers (2024)				
Substation	D Line	Served Load (MW)	Isolated Load (MW)	Notes
Chester	3115X	29.2	9.1	Limited by 2.97 miles of 2/0 CU from P. 377/188 to 377/229 and Prescott Road 333A regulators (120% LTE). Recommended to reconductor and upgrade regulators. Isolated NHEC Chester
Lawrence Road	3133X	19.4	3.8	Limited by 3128R1 pick-up setting and 3128 336 ACSR from Mammoth Road to P. 4/44 (1.24 miles)

Western Region

Western Region – Contingencies with Risk of Isolated Customers (2024)				
Substation	D Line	Served Load (MW)	Isolated Load (MW)	Notes
Chestnut Hill	3178	10.4	10.4	Radial Line
Emerald Street	W9	9.5	9.5	Circuit tie is within the first line section of the W9. Limited by W9 W9R1 pick-up setting
North Keene	76W7	6.4	6.4	Manual circuit tie. Limited by 76W1 4/0 ACSR from North Keene to 192/92 (1.04 miles)
Chestnut Hill	3139	6.3	6.3	Radial Line
North Road	3180	3.9	3.9	Manual circuit tie. Circuit tie is within the first line section of the 3180
Newport	42X3	3.8	3.8	Radial line
Emerald Street	W15	2.9	2.9	Circuit tie is within the first line section of W15. Limited by Emerald Street W185 pick-up setting
Emerald Street	W1	2.4	2.4	Circuit tie is within the first line section of the W1. Limited by 76W1 76W1FX52 at 192/52 and 76W1 4/0 ACSR from North Keene to 192/54 (1.81 miles)
Emerald Street	W185	6.0	2.3	Circuit tie is within the first line section of the W185. Limited by Emerald Street W15 pick-up setting
North Road	316	17.0	2.0	Limited by low voltage on the 316 line. Solved with 1.8 MVAR Cap bank at George Mill Tap

2025

For 2025, the following new feeder breaker/line fault events that may impact customer reliability were identified:

- 0 breaker/line fault events

Any new events are presented in bold within the following tables.

Central Region

Central Region – Contingencies with Risk of Isolated Customers (2025)				
Substation	D Line	Served Load (MW)	Isolated Load (MW)	Notes
Pine Hill	3613	11.2	11.2	Manual Sectionalizing device. Circuit tie is within the first line section
Oak Hill	319	19.8	11.2	Limited by Ingalls Rd Regulators (14.1 MW emergency rating), 336 AL Spacer Madbury-Lee Traffic Circle (3 miles), 336 ACSR Lee Traffic Circle-Northwood Narrows (15.9 miles), 266 ACSR Northwood Narrows- Ingalls Rd (7.9 miles) and low voltage on 319 and 3137X lines
Weare	3108	6.9	6.9	Limited by manual device (3108DX2)
Canal Street	364	5.2	5.2	Limited by manual device (J9064)
Huse Road	393	21.3	4.4	Limited by 2.13 miles of 266 ACSR from P. 3614/66 (3614J35 Mammoth Road RTU) to P. 3614/130 (393J6 Hanover St). Recommend reconductoring 3614
Huse Road	3119	3.8	3.8	Radial line
South State Street	3190	1.4	1.4	Limited by manual device (J9064)

Eastern Region

Eastern Region - Contingencies with Risk of Isolated Customers (2025)				
Substation	D Line	Served Load (MW)	Isolated Load (MW)	Notes
<i>None identified.</i>				

Northern Region

Northern Region – Contingencies with Risk of Isolated Customers (2025)				
Substation	D Line	Served Load (MW)	Isolated Load (MW)	Notes
Whitefield	348	15.6	15.6	Radial line
White Lake	3116X	20.4	14.5	Limited by White Lake 346 line 7.95 Miles of 336 ACSR from White Lake to 346X1 at P.346/605 at 114% Emergency. Isolated Wolfeboro Municipal
Pemigewasset	3114X	13	13.0	Radial Line
Lost Nation	355X	9.8	9.8	Radial Line
Saco Valley	395	9.4	9.4	Radial line. NHEC can restore its own load (7.5 MW)
North Woodstock	3822	8.7	8.7	Requires system upgrades on NHEC's system to utilize Thornton-North Woodstock circuit tie
Ashland	338	29.9	8.5	Requires load cascading. Limited by White Lake XFMRs overload, voltage on 338 line. 345 line (3.73 miles of 336 ACSR from Pemi breaker to 345X2 Tap) would be at 95% emergency rating after cascading. Isolated NHEC Moultonboro. Cap bank installation at Straits Rd and line reconductoring are recommended
Beebe River	342B	8.2	8.2	Manual circuit tie to NHEC. Eversource circuit tie within the first section of the 342A
Laconia	3222X	7.4	7.4	Radial line. SCADA controlled tie within the first section
Webster	3193	6.1	6.1	Radial line feeding NHEC Webster
White Lake	346	28.9	5.7	Limited by White Lake 3116X line 6.78 Miles of 336 ACSR from White Lake to J9016 at P.390/307 at 114% emergency rating. Isolated NHEC Tuftonboro
North Woodstock	3126	2.5	2.5	Requires system upgrades on NHEC's system to utilize Thornton-North Woodstock circuit tie
Lost Nation	384	0.6	0.6	Radial Line

Southern Region

Southern Region – Contingencies with Risk of Isolated Customers (2025)				
Substation	D Line	Served Load (MW)	Isolated Load (MW)	Notes
Chester	3115X	29.2	9.1	Limited by 2.97 miles of 2/0 CU from P. 377/188 to 377/229 and Prescott Road 333A regulators (120% LTE). Recommended to re-conductor and upgrade regulators. Isolated NHEC Chester
Lawrence Road	3133X	19.5	3.8	Limited by 3128R1 pick-up setting and 3128 336 ACSR from Mammoth Road to P. 4/44 (1.24 miles)

Western Region

Western Region – Contingencies with Risk of Isolated Customers (2025)				
Substation	D Line	Served Load (MW)	Isolated Load (MW)	Notes
Chestnut Hill	3178	10.4	10.4	Radial Line
Emerald Street	W9	9.5	9.5	Circuit tie is within the first line section of the W9. Limited by W9 W9R1 pick-up setting
North Keene	76W7	6.4	6.4	Manual circuit tie. Limited by 76W1 4/0 ACSR from North Keene to 192/92 (1.04 miles)
Chestnut Hill	3139	6.3	6.3	Radial Line
North Road	3180	3.9	3.9	Manual circuit tie. Circuit tie is within the first line section of the 3180
Newport	42X3	3.8	3.8	Radial line
Emerald Street	W15	2.9	2.9	Circuit tie is within the first line section of W15. Limited by Emerald Street W185 pick-up setting
Emerald Street	W1	2.4	2.4	Circuit tie is within the first line section of the W1. Limited by 76W1 76W1FX52 at 192/52 and 76W1 4/0 ACSR from North Keene to 192/54 (1.81 miles)
Emerald Street	W185	6.0	2.3	Circuit tie is within the first line section of the W185. Limited by Emerald Street W15 pick-up setting
North Road	316	17.0	2.0	Limited by low voltage on the 316 line. Solved with 1.8 MVAR Cap bank at George Mill Tap

2029

For 2029, the following new feeder breaker/line fault events that may impact customer reliability were identified:

- 0 breaker/line fault events

Any new events are presented in bold within the following tables.

Central Region

Central Region – Contingencies with Risk of Isolated Customers (2029)				
Substation	D Line	Served Load (MW)	Isolated Load (MW)	Notes
Pine Hill	3613	11.3	11.3	Manual Sectionalizing device. Circuit tie is within the first line section
Oak Hill	319	20.2	11.3	Limited by Ingalls Rd Regulators (14.1 MW emergency rating), 336 AL Spacer Madbury-Lee Traffic Circle (3 miles), 336 ACSR Lee Traffic Circle-Northwood Narrows (15.9 miles), 266 ACSR Northwood Narrows- Ingalls Rd (7.9 miles) and low voltage on 319 and 3137X lines
Huse Road	393	21.3	7.9	Limited by 2.13 miles of 266 ACSR from P. 3614/66 (3614J35 Mammoth Road RTU) to P. 3614/130 (393J6 Hanover St). Recommend reconductoring 3614
Weare	3108	7.0	7.0	Limited by manual device (3108DX2)
Canal Street	364	5.2	5.2	Limited by manual device (J9064)
Huse Road	3119	3.9	3.9	Radial line
South State Street	3190	1.4	1.4	Limited by manual device (J9064)

Eastern Region

Eastern Region – Contingencies with Risk of Isolated Customers (2029)					
Substation	D Line	Served Load (MW)	Isolated Load (MW)	Notes	Significance (1-3)
<i>None identified.</i>					

Northern Region

Northern Region – Contingencies with Risk of Isolated Customers (2029)				
Substation	D Line	Served Load (MW)	Isolated Load (MW)	Notes
Whitefield	348	15.9	15.9	Radial line
White Lake	3116X	20.5	14.5	Limited by White Lake 346 line 7.95 Miles of 336 ACSR from White Lake to 346X1 at P.346/605 at 114% Emergency. Isolated Wolfeboro Municipal
Pemigewasset	3114X	13.3	13.3	Radial Line
White Lake	346	29.6	12.3	Limited by White Lake 3116X line 6.78 Miles of 336 ACSR from White Lake to J9016 at P.390/307 at 114% emergency rating. Isolated NHEC Tuftonboro & 346X1
Lost Nation	355X	10.1	10.1	Radial Line
Saco Valley	395	9.6	9.6	Radial line. NHEC can restore its own load (7.6 MW)
North Woodstock	3822	9.0	9.0	Requires system upgrades on NHEC's system to utilize Thornton-North Woodstock circuit tie
Ashland	338	30.4	8.5	Requires load cascading. Limited by White Lake XFMRs overload, voltage on 338 line. 345 line (3.73 miles of 336 ACSR from Pemi breaker to 345X2 Tap) at 98% emergency rating after cascading. Isolated NHEC Moultonboro. Cap bank installation at Straits Rd and line reconductoring are recommended
Beebe River	342B	8.4	8.4	Manual circuit tie to NHEC. Eversource circuit tie within the first section of the 342A
Laconia	3222X	7.5	7.5	Radial line. SCADA controlled tie within the first section
Webster	3193	6.1	6.1	Radial line feeding NHEC Webster
North Woodstock	3126	2.5	2.5	Requires system upgrades on NHEC's system to utilize Thornton-North Woodstock circuit tie
Lost Nation	384	0.6	0.6	Radial Line

Southern Region

Southern Region – Contingencies with Risk of Isolated Customers (2029)				
Substation	D Line	Served Load (MW)	Isolated Load (MW)	Notes
Chester	3115X	29.5	9.1	Limited by 2.97 miles of 2/0 CU from P. 377/188 to 377/229 and Prescott Road 333A regulators (120% LTE). Recommended to reconductor and upgrade regulators. Isolated NHEC Chester
Lawrence Road	3133X	19.7	3.8	Limited by 3128R1 pick-up setting and 3128 336 ACSR from Mammoth Road to P. 4/44 (1.24 miles)

Western Region

Western Region – Contingencies with Risk of Isolated Customers (2029)				
Substation	D Line	Served Load (MW)	Isolated Load (MW)	Notes
Chestnut Hill	3178	10.7	10.7	Radial Line
Emerald Street	W9	9.7	9.7	Circuit tie is within the first line section of the W9. Limited by W9 W9R1 pick-up setting
North Keene	76W7	6.6	6.6	Manual circuit tie. Limited by 76W1 4/0 ACSR from North Keene to 192/92 (1.04 miles)
Chestnut Hill	3139	6.5	6.5	Radial Line
North Road	3180	4.0	4.0	Manual circuit tie. Circuit tie is within the first line section of the 3180
Newport	42X3	3.9	3.9	Radial line
Emerald Street	W15	3.0	3.0	Circuit tie is within the first line section of W15. Limited by Emerald Street W185 pick-up setting
Emerald Street	W1	2.5	2.5	Circuit tie is within the first line section of the W1. Limited by 76W1 76W1FX52 at 192/52 and 76W1 4/0 ACSR from North Keene to 192/54 (1.81 miles)
Emerald Street	W185	6.2	2.3	Circuit tie is within the first line section of the W185. Limited by Emerald Street W15 pick-up setting
North Road	316	17.4	2.0	Limited by low voltage on the 316 line. Solved with 1.8 MVAR Cap bank at George Mill Tap

Bulk Substation Bus Fault Study

The following chapter is a year-by-year review of bulk substation bus faults. The information presented here is to gain an understanding of where customer risk is the highest for a bus fault.

The following system constraints were determined based on the following criteria:

	N-1 Contingency
Transformer Loading	> 100% LTE
Line Loading	> 100% emergency
Voltage, Unregulated Load	< 95%
Voltage, Regulated Load	< 92.5%
Load Block Transfer Limit	3
Remaining Isolated Load	> 0 MW

Definitions:

- Regulated Load** Load that has voltage regulation at a 34.5kV primary voltage beyond the Bulk Distribution Facility. The system load is all beyond a PSNH voltage regulated source (line regulator on a tap or non-bulk substation LTC). Primary metered customers are considered regulated load because regulation is their responsibility in accordance with the Tariff.
- Unregulated Load** Load that has no voltage regulation at the 34.5 kV primary voltage beyond a Bulk Distribution Facility. The voltage of the system load is not regulated beyond the 34.5 kV point modeled for planning by System Planning and Strategy.

2020

General Discussion

For 2020, the following design criteria violations were identified:

- 30 substations have bus fault violations

Suggested Projects

The following projects are suggested to address bus faults that may impact customer reliability. This is a partial list of solution options as some scenarios require a local study to be performed to determine a feasible solution. The projects proposed here require additional study to determine if they are the optimal solution for the contingency identified.

Contingencies Solution Options

- Chestnut Hill Bus Fault
 - Upgrade Chestnut Hill transformers and automate the circuit tie outside of the substation.
- Huse Road Bus Fault
 - Reconductor 2.13 miles of 266 ACSR from P. 3614/66 (3614J35 Mammoth Road RTU) to P. 3614/130 (393J6 Hanover St).
- Pemigewasset Bus Fault
 - Reconductor 345 line 3.73 miles of 336 ACSR from substation breaker to 345X2 tap.
- Webster (Daniel Bus 2) Bus Fault
 - Automate 3216J2 manual circuit tie switch.
- White Lake Bus Fault
 - Upgrade White Lake transformers and automate circuit ties outside the substation to restore entire load via Saco Valley.

Central Region

Central Region – Bus Faults with Risk of Isolated Customers (2020)			
Substation	Bus #	Isolated Load (MW)	Notes
Huse Road	Bus 1/2/3	34.0	Limited by 2.13 miles of 266 ACSR from P. 3614/66 (3614J35 Mammoth Road RTU) to P. 3614/130 (393J6 Hanover St). and 3119 Radial line Isolated load reduced to 8 MW after 6 load block transfers Isolates 4.3 MW on the 393 Line; 3.7 MW Radial (3119) Recommend reconductoring 3614
Garvins	Bus 1/2	23.9	Isolated UES 374 line. Limited by Oak Hill XFMRs, Penacook-Bridge lines and voltage
Oak Hill	Bus 1/2	10.9	Limited by Ingalls Rd Regulators (14.1 MW emergency rating) Limited by 336 AL Spacer Madbury-Lee Traffic Circle (3 miles) Limited by 336 ACSR Lee Traffic Circle-Northwood Narrows (15.9 miles) Limited by 266 ACSR Northwood Narrows- Ingalls Rd (7.9 miles) Limited by low voltage on 319 and 3137X lines Load can be restored using 319-3025 manual circuit tie

Eastern Region

Eastern Region – Bus Faults with Risk of Isolated Customers (2020)			
Substation	Bus #	Isolated Load (MW)	Notes
Dover	Bus 1/2	40.5	Limited by voltage and Rochester XFMRs/lines overload. New Dover XFMRs scheduled for December 2024 will reduce the isolated load to 4.9 MW
Madbury	Bus 1/2/3	35.4	Limited by 319 line 5.7 miles of 3/0 ACSR (Oak Hill breaker-Ingalls Rd), line regulator overload, low voltage. Isolated load is reduced to 26.3 MW after 4 load block transfers. Bus tie with breakers rearrangement would allow for a complete restoration
Mill Pond	Bus 1	10.6	Limited by Cutts St, Foyes Corner, Jackson Hill and Lafayette Rd XFMRs; Manual Switches; Breakers CT; Solid Cutouts. Additional 1 MW can be restored via manual switching. Need DA devices to sectionalize the lines and pick up load partially

Northern Region

Northern Region – Bus Faults with Risk of Isolated Customers (2020)			
Substation	Bus #	Isolated Load (MW)	Notes
White Lake	Bus 1/2/3	42.8	Limited by 338 line overload and voltage. Load will be fully restored once White Lake transformers are upgraded and circuit ties outside the substation are automated, scheduled for December 2023
Laconia	Bus 1/2/3	41.7	Limited by 345 line 3.73 miles of 336 ACSR from Pemi breaker to 345X2 TAP, Mobile TX106 and 310 & 3222 radial lines. Bus Tie breaker installation is recommended
Whitefield	Bus	16.5	No SCADA controlled circuit ties. Isolated TB1W (1.3 MW) and 348X line (15.2 MW)
Berlin	Bus 1/2	15.2	Limited by voltage on 351. Isolated 3521 line (4 MW) and 3525X line (11.2 MW). Installation of line Cap banks may allow to restore entire load
Beebe River	Bus 1/2	14.9	Same as Beebe River TB62 transformer contingency
Ashland	Bus 1/2	13.5	Limited by mobile TX106 overload, 346 336 ACSR, voltage & White Lake XFMRs
Pemigewasset	Bus	12.6	Limited by low voltage on the 3114X line. Isolated load is reduced to 1.8 MW after 4 load block transfers
North Woodstock	Bus	10.8	Requires system upgrades on NHEC's system to utilize Thornton-North Woodstock circuit tie
Saco Valley	Bus 1/2	8.7	Limited by White Lake XFMRs and manual switching
Webster	Daniel Bus 2	6.0	Limited by manual device (3216J2). Isolated 3193 Radial line feeding NHEC Webster
Lost Nation	Bus 1/2	0.6	Isolated 384 radial line. Recommended to automate the J554 switch

Southern Region

Southern Region – Bus Faults with Risk of Isolated Customers (2020)			
Substation	Bus #	Isolated Load (MW)	Notes
Amherst	Bus 1	48.5	Limited by South Milford XFMR. New transformer scheduled for 2022 would allow complete restoration
Long Hill	Bus 1/2	17.3	Same as P134 contingency
Amherst	Bus 2	16.0	Complete restoration requires more than 5 load block transfers
South Milford	Bus 2	10.7	Reprogram bi-directional regulators to pick up remaining load and Reconductor 3212X: 3.45 miles 336 ACSR from Amherst S/S to South Milford Tap
Scobie Pond	Bus 1	10.3	Isolated 32W5. Limited by 32W4 conductor size
Hudson	Bus 1/2	10.2	Load can be fully restored in 4 load block transfers
Bridge Street (4 kV)	Bus 1/2	7.8	No SCADA switching on the Nashua 4 kV
Bridge Street (34 kV)	Bus A/B	6.0	Load can be fully restored in 4 load block transfers

Western Region

Western Region – Bus Faults with Risk of Isolated Customers (2020)			
Substation	Bus #	Isolated Load (MW)	Notes
North Road	Bus 1/2	38.4	Limited by 5.85 Miles #2 CU Davisville to Warner, Low voltage on 316 line. Recommended replacing J89 with Bus Tie and Moving 316 to Bus 1. Partially solved with bus tie and 1.8 MVAR cap bank on George Mill tap.
Chestnut Hill	Bus 1/2	6.1/10.1	Isolated load can be reduced to 4 MW using manual switching
North Keene	Bus 1	6.2	Limited by manual circuit tie and 76W1 4/0 ACSR from North Keene to 192/92 (1.04 miles). Isolated 76W7.
Jackman	Bus 1/2/3	5.5	Limited by 313 voltage & line regulators overload and 313R2 pick-up setting
Monadnock	Bus 1	5.5	Limited by Monadnock TB40 capacity and 313 line 6.72 miles of 4/0 ACSR P. 313/1 to P. 313/121. Isolated 313X2

2021

General Discussion

For 2021, the following new design criteria violations were identified:

- 0 substations have new bus fault violations

Any new events are presented in bold within the following tables.

Central Region

Central Region – Bus Faults with Risk of Isolated Customers (2021)			
Substation	Bus #	Isolated Load (MW)	Notes
Huse Road	Bus 1/2/3	34.2	Limited by 2.13 miles of 266 ACSR from P. 3614/66 (3614J35 Mammoth Road RTU) to P. 3614/130 (393J6 Hanover St). and 3119 Radial line Isolated load reduced to 8.1 MW after 6 load block transfers Isolates 4.3 MW on the 393 Line; 3.8 MW Radial (3119) Recommend reconductoring 3614
Garvins	Bus 1/2	24.1	Isolated UES 374 line. Limited by Oak Hill XFMRs, Penacook-Bridge lines and voltage
Oak Hill	Bus 2	11.1	Limited by Ingalls Rd Regulators (14.1 MW emergency rating) Limited by 336 AL Spacer Madbury-Lee Traffic Circle (3 miles) Limited by 336 ACSR Lee Traffic Circle-Northwood Narrows (15.9 miles) Limited by 266 ACSR Northwood Narrows- Ingalls Rd (7.9 miles) Limited by low voltage on 319 and 3137X lines Load can be restored using 319-3025 manual circuit tie

Eastern Region

Eastern Region – Bus Faults with Risk of Isolated Customers (2021)			
Substation	Bus #	Isolated Load (MW)	Notes
Dover	Bus 1/2	41.1	Limited by voltage and Rochester XFMRs/lines overload. New Dover XFMRs scheduled for December 2024 will reduce the isolated load to 4.9 MW
Madbury	Bus 1/2/3	35.4	Limited by 319 line 5.7 miles of 3/0 ACSR (Oak Hill breaker-Ingalls Rd), line regulator overload, low voltage. Isolated load is reduced to 26.3 MW after 4 load block transfers. Bus tie with breakers rearrangement would allow for a complete restoration
Mill Pond	Bus 1	11.1	Limited by Cutts St, Foyes Corner, Jackson Hill and Lafayette Rd XFMRs; Manual Switches; Breakers CT; Solid Cutouts. Additional 1 MW can be restored via manual switching. Need DA devices to sectionalize the lines and pick up load partially

Northern Region

Northern Region – Bus Faults with Risk of Isolated Customers (2021)			
Substation	Bus #	Isolated Load (MW)	Notes
White Lake	Bus 1/2/3	43.2	Limited by 338 line overload and voltage. Load will be fully restored once White Lake transformers are upgraded and circuit ties outside the substation are automated, scheduled for December 2023
Laconia	Bus 1/2/3	26.3	Limited by 345 line 3.73 miles of 336 ACSR from Pemi breaker to 345X2 TAP and the 310 & 3222 radial lines. Bus Tie breaker installation is recommended
Whitefield	Bus	16.7	No SCADA controlled circuit ties. Isolated TB1W (1.4 MW) and 348X line (15.3 MW)
Berlin	Bus 1/2	15.2	Limited by voltage on 351. Isolated 3521 line (4 MW) and 3525X line (11.2 MW). Installation of line Cap banks may allow to restore entire load
Beebe River	Bus 1/2	15.1	Same as Beebe River TB62 transformer contingency
Pemigewasset	Bus	12.7	Limited by low voltage on the 3114X line. Isolated load is reduced to 1.9 MW after 4 load block transfers
North Woodstock	Bus	10.9	Requires system upgrades on NHEC's system to utilize Thornton-North Woodstock circuit tie
Saco Valley	Bus 1/2	9.3	Limited by White Lake XFMRs and manual switching
Ashland	Bus 1/2	8.4	Limited by 346 336 ACSR, voltage & White Lake XFMRs
Webster	Daniel Bus 2	6.0	Limited by manual device (3216J2). Isolated 3193 Radial line feeding NHEC Webster
Lost Nation	Bus 1/2	0.6	Isolated 384 radial line. Recommended to automate the J554 switch

Southern Region

Southern Region – Bus Faults with Risk of Isolated Customers (2021)			
Substation	Bus #	Isolated Load (MW)	Notes
Amherst	Bus 1	48.8	Limited by South Milford XFMR. New transformer scheduled for 2022 would allow complete restoration
Long Hill	Bus 1/2	17.5	Same as P134 contingency
Amherst	Bus 2	16.0	Complete restoration requires more than 5 load block transfers
South Milford	Bus 2	10.8	Recommended to reconductor 3212X 3.45 miles 336 ACSR from Amherst S/S to South Milford Tap
Scobie Pond	Bus 1	10.3	Isolated 32W5. Limited by 32W4 conductor size
Hudson	Bus 1/2	10.2	Load can be fully restored in 4 load block transfers
Bridge Street (4 kV)	Bus 1/2	7.8	No SCADA switching on the Nashua 4 kV
Bridge Street (34 kV)	Bus A/B	6.1	Load can be fully restored in 4 load block transfers

Western Region

Western Region – Bus Faults with Risk of Isolated Customers (2021)			
Substation	Bus #	Isolated Load (MW)	Notes
North Road	Bus 1/2	38.8	Limited by 5.85 Miles #2 CU Davisville to Warner, Low voltage on 316 line. Recommended replacing J89 with Bus Tie and Moving 316 to Bus 1. Partially solved with bus tie and 1.8 MVAR cap bank on George Mill tap.
Chestnut Hill	Bus 1/2	6.2/10.2	Isolated load can be reduced to 4 MW using manual switching
North Keene	Bus 1	6.3	Limited by manual circuit tie and 76W1 4/0 ACSR from North Keene to 192/92 (1.04 miles). Isolated 76W7.
Jackman	Bus 1/2/3	5.6	Limited by 313 voltage & line regulators overload and 313R2 pick-up setting
Monadnock	Bus 1	5.6	Limited by Monadnock TB40 capacity and 313 line 6.72 miles of 4/0 ACSR P. 313/1 to P. 313/121. Isolated 313X2

2022

General Discussion

For 2022, the following new design criteria violations were identified:

- 0 substations have new bus fault violations

Any new events are presented in bold within the following tables.

Central Region

Central Region – Bus Faults with Risk of Isolated Customers (2022)			
Substation	Bus #	Isolated Load (MW)	Notes
Huse Road	Bus 1/2/3	34.3	Limited by 2.13 miles of 266 ACSR from P. 3614/66 (3614J35 Mammoth Road RTU) to P. 3614/130 (393J6 Hanover St). and 3119 Radial line Isolated load reduced to 8.1 MW after 6 load block transfers Isolates 4.3 MW on the 393 Line; 3.8 MW Radial (3119) Recommend reconductoring 3614
Garvins	Bus 1/2	24.1	Isolated UES 374 line. Limited by Oak Hill XFMRs, Penacook-Bridge lines and voltage
Oak Hill	Bus 2	11.1	Limited by Ingalls Rd Regulators (14.1 MW emergency rating) Limited by 336 AL Spacer Madbury-Lee Traffic Circle (3 miles) Limited by 336 ACSR Lee Traffic Circle-Northwood Narrows (15.9 miles) Limited by 266 ACSR Northwood Narrows- Ingalls Rd (7.9 miles) Limited by low voltage on 319 and 3137X lines Load can be restored using 319-3025 manual circuit tie

Eastern Region

Eastern Region – Bus Faults with Risk of Isolated Customers (2022)			
Substation	Bus #	Isolated Load (MW)	Notes
Dover	Bus 1/2	42.9	Limited by voltage and Rochester XFMRs/lines overload. New Dover XFMRs scheduled for December 2024 will reduce the isolated load to 4.9 MW
Madbury	Bus 1/2/3	35.4	Limited by 319 line 5.7 miles of 3/0 ACSR (Oak Hill breaker-Ingalls Rd), line regulator overload, low voltage. Isolated load is reduced to 26.3 MW after 4 load block transfers. Bus tie with breakers rearrangement would allow for a complete restoration
Mill Pond	Bus 1	11.2	Limited by Cutts St, Foyes Corner, Jackson Hill and Lafayette Rd XFMRs; Manual Switches; Breakers CT; Solid Cutouts. Additional 1 MW can be restored via manual switching. Need DA devices to sectionalize the lines and pick up load partially

Northern Region

Northern Region – Bus Faults with Risk of Isolated Customers (2022)			
Substation	Bus #	Isolated Load (MW)	Notes
White Lake	Bus 1/2/3	43.4	Limited by 338 line overload and voltage. Load will be fully restored once White Lake transformers are upgraded and circuit ties outside the substation are automated, scheduled for December 2023
Laconia	Bus 1/2/3	26.7	Limited by 345 line 3.73 miles of 336 ACSR from Pemi breaker to 345X2 TAP and the 310 & 3222 radial lines. Bus Tie breaker installation is recommended.
Whitefield	Bus	16.8	No SCADA controlled circuit ties. Isolated TB1W (1.4 MW) and 348X line (15.4 MW)
Berlin	Bus 1/2	15.4	Limited by voltage on 351. Isolated 3521 line (4.1 MW) and 3525X line (11.3 MW). Installation of line Cap banks may allow to restore entire load
Beebe River	Bus 1/2	15.2	Same as Beebe River TB62 transformer contingency
Pemigewasset	Bus	12.8	Limited by low voltage on the 3114X line. Entire load can be restored after 4 load block transfers
North Woodstock	Bus	11.0	Requires system upgrades on NHEC's system to utilize Thornton-North Woodstock circuit tie
Saco Valley	Bus 1/2	9.3	Limited by White Lake XFMRs and manual switching
Ashland	Bus 1/2	8.4	Limited by 346 336 ACSR, voltage & White Lake XFMRs
Webster	Daniel Bus 2	6.1	Limited by manual device (3216J2). Isolated 3193 Radial line feeding NHEC Webster
Lost Nation	Bus 1/2	0.6	Isolated 384 radial line. Recommended to automate the J554 switch

Southern Region

Southern Region – Bus Faults with Risk of Isolated Customers (2022)			
Substation	Bus #	Isolated Load (MW)	Notes
Amherst	Bus 1	31.4	Limited by South Milford XFMR. New transformer scheduled for 2022 would allow complete restoration
Long Hill	Bus 1/2	17.5	Same as P134 contingency
Amherst	Bus 2	16.1	Complete restoration requires more than 5 load block transfers
South Milford	Bus 2	10.9	Recommended to reconductor 3212X 3.45 miles 336 ACSR from Amherst S/S to South Milford Tap
Scobie Pond	Bus 1	10.4	Isolated 32W5. Limited by 32W4 conductor size
Hudson	Bus 1/2	10.2	Load can be fully restored in 4 load block transfers
Bridge Street (4kV)	Bus 1/2	7.9	No SCADA switching on the Nashua 4 kV
Bridge Street (34 kV)	Bus A/B	6.1	Load can be fully restored in 4 load block transfers

Western Region

Western Region – Bus Faults with Risk of Isolated Customers (2022)			
Substation	Bus #	Isolated Load (MW)	Notes
North Road	Bus 1/2	38.8	Limited by 5.85 Miles #2 CU Davisville to Warner, Low voltage on 316 line. Recommended replacing J89 with Bus Tie and Moving 316 to Bus 1. Partially solved with bus tie and 1.8 MVAR cap bank on George Mill tap
Chestnut Hill	Bus 1/2	6.2/10.2	Isolated load can be reduced to 4 MW using manual switching
North Keene	Bus 1	6.3	Limited by manual circuit tie and 76W1 4/0 ACSR from North Keene to 192/92 (1.04 miles). Isolated 76W7
Jackman	Bus 1/2/3	5.6	Limited by 313 voltage & line regulators overload and 313R2 pick-up setting
Monadnock	Bus 1	5.6	Limited by Monadnock TB40 capacity and 313 line 6.72 miles of 4/0 ACSR P. 313/1 to P. 313/121. Isolated 313X2

2023

General Discussion

For 2023, the following new design criteria violations were identified:

- 0 substations have new bus fault violations

Any new events are presented in bold within the following tables.

Central Region

Central Region – Bus Faults with Risk of Isolated Customers (2023)			
Substation	Bus #	Isolated Load (MW)	Notes
Huse Road	Bus 1/2/3	34.5	Limited by 2.13 miles of 266 ACSR from P. 3614/66 (3614J35 Mammoth Road RTU) to P. 3614/130 (393J6 Hanover St). and 3119 Radial line Isolated load reduced to 8.1 MW after 6 load block transfers Isolates 4.3 MW on the 393 Line; 3.8 MW Radial (3119) Recommend reconductoring 3614
Garvins	Bus 1/2	24.2	Isolated UES 374 line. Limited by Oak Hill XFMRs, Penacook-Bridge lines and voltage
Oak Hill	Bus 2	11.1	Limited by Ingalls Rd Regulators (14.1 MW emergency rating) Limited by 336 AL Spacer Madbury-Lee Traffic Circle (3 miles) Limited by 336 ACSR Lee Traffic Circle-Northwood Narrows (15.9 miles) Limited by 266 ACSR Northwood Narrows- Ingalls Rd (7.9 miles) Limited by low voltage on 319 and 3137X lines Load can be restored using 319-3025 manual circuit tie

Eastern Region

Eastern Region – Bus Faults with Risk of Isolated Customers (2023)			
Substation	Bus #	Isolated Load (MW)	Notes
Dover	Bus 1/2	43.0	Limited by voltage and Rochester XFMRs/lines overload. New Dover XFMRs scheduled for December 2024 will reduce the isolated load to 4.9 MW
Madbury	Bus 1/2/3	35.4	Limited by 319 line 5.7 miles of 3/0 ACSR (Oak Hill breaker-Ingalls Rd), line regulator overload, low voltage. Isolated load is reduced to 26.3 MW after 4 load block transfers. Bus tie with breakers rearrangement would allow for a complete restoration
Mill Pond	Bus 1	11.2	Limited by Cutts St, Foyes Corner, Jackson Hill and Lafayette Rd XFMRs; Manual Switches; Breakers CT; Solid Cutouts. Additional 1 MW can be restored via manual switching. Need DA devices to sectionalize the lines and pick up load partially

Northern Region

Northern Region – Bus Faults with Risk of Isolated Customers (2023)			
Substation	Bus #	Isolated Load (MW)	Notes
White Lake	Bus 1/2/3	43.5	Limited by 338 line overload and voltage. Load will be fully restored once White Lake transformers are upgraded and circuit ties outside the substation are automated, scheduled for December 2023
Laconia	Bus 1/2/3	26.7	Limited by 345 line 3.73 miles of 336 ACSR from Pemi breaker to 345X2 TAP and the 310 & 3222 radial lines. Bus Tie breaker installation is recommended.
Whitefield	Bus	16.8	No SCADA controlled circuit ties. Isolated TB1W (1.4 MW) and 348X line (15.4 MW)
Berlin	Bus 1/2	15.4	Limited by voltage on 351. Isolated 3521 line (4.1 MW) and 3525X line (11.3 MW). Installation of line Cap banks may allow to restore entire load
Beebe River	Bus 1/2	15.2	Same as Beebe River TB62 transformer contingency
Pemigewasset	Bus	12.9	Limited by low voltage on the 3114X line. Entire load can be restored after 4 load block transfers
North Woodstock	Bus	11.0	Requires system upgrades on NHEC's system to utilize Thornton-North Woodstock circuit tie
Saco Valley	Bus 1/2	9.3	Limited by White Lake XFMRs and manual switching
Ashland	Bus 1/2	8.4	Limited by 346 336 ACSR, voltage & White Lake XFMRs
Webster	Daniel Bus 2	6.1	Limited by manual device (3216J2). Isolated 3193 Radial line feeding NHEC Webster
Lost Nation	Bus 1/2	0.6	Isolated 384 radial line. Recommended to automate the J554 switch

Southern Region

Southern Region – Bus Faults with Risk of Isolated Customers (2023)			
Substation	Bus #	Isolated Load (MW)	Notes
Amherst	Bus 1	31.5	Limited by South Milford XFMR. New transformer scheduled for 2022 would allow complete restoration
Long Hill	Bus 1/2	17.5	Same as P134 contingency
Amherst	Bus 2	16.1	Complete restoration requires more than 5 load block transfers
South Milford	Bus 2	11.0	Recommended to reconductor 3212X 3.45 miles 336 ACSR from Amherst S/S to South Milford Tap
Scobie Pond	Bus 1	10.4	Isolated 32W5. Limited by 32W4 conductor size
Hudson	Bus 1/2	10.2	Load can be fully restored in 4 load block transfers
Bridge Street (4 kV)	Bus 1/2	7.9	No SCADA switching on the Nashua 4 kV
Bridge Street (34 kV)	Bus A/B	6.1	Load can be fully restored in 4 load block transfers

Western Region

Western Region – Bus Faults with Risk of Isolated Customers (2023)			
Substation	Bus #	Isolated Load (MW)	Notes
North Road	Bus 1/2	39.0	Limited by 5.85 Miles #2 CU Davisville to Warner, Low voltage on 316 line. Recommended replacing J89 with Bus Tie and Moving 316 to Bus 1. Partially solved with bus tie and 1.8 MVAR cap bank on George Mill tap.
Chestnut Hill	Bus 1/2	6.3/10.3	Isolated load can be reduced to 4.1 MW using manual switching
North Keene	Bus 1	6.3	Limited by manual circuit tie and 76W1 4/0 ACSR from North Keene to 192/92 (1.04 miles). Isolated 76W7
Jackman	Bus 1/2/3	5.6	Limited by 313 voltage & line regulators overload and 313R2 pick-up setting

2024

General Discussion

For 2024, the following new design criteria violations were identified:

- 0 substations have new bus fault violations

Any new events are presented in bold within the following tables.

Central Region

Central Region – Bus Faults with Risk of Isolated Customers (2024)			
Substation	Bus #	Isolated Load (MW)	Notes
Huse Road	Bus 1/2/3	34.5	Limited by 2.13 miles of 266 ACSR from P. 3614/66 (3614J35 Mammoth Road RTU) to P. 3614/130 (393J6 Hanover St). and 3119 Radial line Isolated load reduced to 8.1 MW after 6 load block transfers Isolates 4.3 MW on the 393 Line; 3.8 MW Radial (3119) Recommend reconductoring 3614
Garvins	Bus 1/2	24.3	Isolated UES 374 line. Limited by Oak Hill XFMRs, Penacook-Bridge lines and voltage
Oak Hill	Bus 2	11.1	Limited by Ingalls Rd Regulators (14.1 MW emergency rating) Limited by 336 AL Spacer Madbury-Lee Traffic Circle (3 miles) Limited by 336 ACSR Lee Traffic Circle-Northwood Narrows (15.9 miles) Limited by 266 ACSR Northwood Narrows- Ingalls Rd (7.9 miles) Limited by low voltage on 319 and 3137X lines Load can be restored using 319-3025 manual circuit tie

Eastern Region

Eastern Region – Bus Faults with Risk of Isolated Customers (2024)			
Substation	Bus #	Isolated Load (MW)	Notes
Dover	Bus 1/2	43.0	Limited by voltage and Rochester XFMRs/lines overload. New Dover XFMRs scheduled for December 2024 will reduce the isolated load to 4.9 MW
Madbury	Bus 1/2/3	35.4	Limited by 319 line 5.7 miles of 3/0 ACSR (Oak Hill breaker-Ingalls Rd), line regulator overload, low voltage. Isolated load is reduced to 26.3 MW after 4 load block transfers. Bus tie with breakers rearrangement would allow for a complete restoration
Mill Pond	Bus 1	4.9	Isolated 71W4. Full restoration is possible with utilizing a manual circuit tie

Northern Region

Northern Region – Bus Faults with Risk of Isolated Customers (2024)			
Substation	Bus #	Isolated Load (MW)	Notes
Laconia	Bus 1/2/3	26.8	Limited by 345 line 3.73 miles of 336 ACSR from Pemi breaker to 345X2 TAP and the 310 & 3222 radial lines. Bus Tie breaker installation is recommended.
Whitefield	Bus	16.9	No SCADA controlled circuit ties. Isolated TB1W (1.4 MW) and 348X line (15.5 MW)
Berlin	Bus 1/2	15.5	Limited by voltage on 351. Isolated 3521 line (4.1 MW) and 3525X line (11.4 MW). Installation of line Cap banks may allow to restore entire load
Beebe River	Bus 1/2	15.3	Same as Beebe River TB62 transformer contingency
Pemigewasset	Bus	13.0	Limited by low voltage on the 3114X line. Entire load can be restored after 4 load block transfers
North Woodstock	Bus	11.0	Requires system upgrades on NHEC's system to utilize Thornton-North Woodstock circuit tie
Saco Valley	Bus 1/2	9.4	Isolated 395 radial line. Can be restored via manual circuit tie
Ashland	Bus 1/2	8.4	Limited by 346 336 ACSR, voltage & White Lake XFMRs
Webster	Daniel Bus 2	6.1	Limited by manual device (3216J2). Isolated 3193 Radial line feeding NHEC Webster
Lost Nation	Bus 1/2	0.6	Isolated 384 radial line. Recommended to automate the J554 switch

Southern Region

Southern Region – Bus Faults with Risk of Isolated Customers (2024)			
Substation	Bus #	Isolated Load (MW)	Notes
Long Hill	Bus 1/2	17.5	Same as P134 contingency
Amherst	Bus 2	16.2	Complete restoration requires 5 load block transfers
Scobie Pond	Bus 1	10.4	Isolated 32W5. Limited by 32W4 conductor size
Hudson	Bus 1/2	10.3	Load can be fully restored in 4 load block transfers
Bridge Street (4 kV)	Bus 1/2	7.9	No SCADA switching on the Nashua 4 kV
Bridge Street (34 kV)	Bus A/B	6.1	Load can be fully restored in 4 load block transfers

Western Region

Western Region – Bus Faults with Risk of Isolated Customers (2024)			
Substation	Bus #	Isolated Load (MW)	Notes
North Road	Bus 1/2	39.2	Limited by 5.85 Miles #2 CU Davisville to Warner, Low voltage on 316 line. Recommended replacing J89 with Bus Tie and Moving 316 to Bus 1. Partially solved with bus tie and 1.8 MVAR cap bank on George Mill tap.
Chestnut Hill	Bus 1/2	6.3/10.4	Isolated load can be reduced to 4.1 MW using manual switching
North Keene	Bus 1	6.4	Limited by manual circuit tie and 76W1 4/0 ACSR from North Keene to 192/92 (1.04 miles). Isolated 76W7.
Jackman	Bus 1/2/3	5.7	Limited by 313 voltage & line regulators overload and 313R2 pick-up setting

2025

General Discussion

For 2025, the following new design criteria violations were identified:

- 0 substations have new bus fault violations

Any new events are presented in bold within the following tables.

Central Region

Central Region – Bus Faults with Risk of Isolated Customers (2025)			
Substation	Bus #	Isolated Load (MW)	Notes
Huse Road	Bus 1/2/3	34.7	Limited by 2.13 miles of 266 ACSR from P. 3614/66 (3614J35 Mammoth Road RTU) to P. 3614/130 (393J6 Hanover St). and 3119 Radial line Isolated load reduced to 8.1 MW after 6 load block transfers Isolates 4.3 MW on the 393 Line; 3.8 MW Radial (3119) Recommend reconductoring 3614
Garvins	Bus 1/2	24.3	Isolated UES 374 line. Limited by Oak Hill XFMRs, Penacook-Bridge lines and voltage
Oak Hill	Bus 2	11.2	Limited by Ingalls Rd Regulators (14.1 MW emergency rating) Limited by 336 AL Spacer Madbury-Lee Traffic Circle (3 miles) Limited by 336 ACSR Lee Traffic Circle-Northwood Narrows (15.9 miles) Limited by 266 ACSR Northwood Narrows- Ingalls Rd (7.9 miles) Limited by low voltage on 319 and 3137X lines Load can be restored using 319-3025 manual circuit tie

Eastern Region

Eastern Region – Bus Faults with Risk of Isolated Customers (2025)			
Substation	Bus #	Isolated Load (MW)	Notes
Madbury	Bus 1/2/3	35.4	Limited by 319 line 5.7 miles of 3/0 ACSR (Oak Hill breaker-Ingalls Rd), line regulator overload, low voltage. Isolated load is reduced to 26.3 MW after 4 load block transfers. Bus tie with breakers rearrangement would allow for a complete restoration
Dover	Bus 2	4.9	Limited by voltage. Isolated Somersworth substation. Load can be fully restored in 4 load block transfers
Mill Pond	Bus 1	4.9	Isolated 71W4. Full restoration is possible with utilizing a manual circuit tie

Northern Region

Northern Region – Bus Faults with Risk of Isolated Customers (2025)			
Substation	Bus #	Isolated Load (MW)	Notes
Laconia	Bus 1/2/3	27.0	Limited by 345 line 3.73 miles of 336 ACSR from Pemi breaker to 345X2 TAP and the 310 & 3222 radial lines. Bus Tie breaker installation is recommended.
Whitefield	Bus	17.0	No SCADA controlled circuit ties. Isolated TB1W (1.4 MW) and 348X line (15.6 MW)
Berlin	Bus 1/2	15.5	Limited by voltage on 351. Isolated 3521 line (4.1 MW) and 3525X line (11.4 MW). Installation of line Cap banks may allow to restore entire load
Pemigewasset	Bus	13.0	Limited by low voltage on the 3114X line. Entire load can be restored after 4 load block transfers
North Woodstock	Bus	11.1	Requires system upgrades on NHEC's system to utilize Thornton-North Woodstock circuit tie
Saco Valley	Bus 1/2	9.4	Isolated 395 radial line. Can be restored via manual circuit tie
Webster	Daniel Bus 2	6.1	Limited by manual device (3216J2). Isolated 3193 Radial line feeding NHEC Webster
Lost Nation	Bus 1/2	0.6	Isolated 384 radial line. Recommended to automate the J554 switch

Southern Region

Southern Region – Bus Faults with Risk of Isolated Customers (2025)			
Substation	Bus #	Isolated Load (MW)	Notes
Long Hill	Bus 1/2	17.5	Same as P134 contingency
Amherst	Bus 2	16.2	Complete restoration requires 5 load block transfers
Scobie Pond	Bus 1	10.4	Isolated 32W5. Limited by 32W4 conductor size
Hudson	Bus 1/2	10.3	Load can be fully restored in 4 load block transfers
Bridge Street (4 kV)	Bus 1/2	7.9	No SCADA switching on the Nashua 4 kV
Bridge Street (34 kV)	Bus A/B	6.1	Load can be fully restored in 4 load block transfers

Western Region

Western Region – Bus Faults with Risk of Isolated Customers (2025)			
Substation	Bus #	Isolated Load (MW)	Notes
North Road	Bus 1/2	39.3	Limited by 5.85 Miles #2 CU Davisville to Warner, Low voltage on 316 line. Recommended replacing J89 with Bus Tie and Moving 316 to Bus 1. Partially solved with bus tie and 1.8 MVAR cap bank on George Mill tap.
Chestnut Hill	Bus 1/2	6.3/10.4	Isolated load can be reduced to 4.1 MW using manual switching
North Keene	Bus 1	6.4	Limited by manual circuit tie and 76W1 4/0 ACSR from North Keene to 192/92 (1.04 miles). Isolated 76W7.
Jackman	Bus 1/2/3	5.7	Limited by 313 voltage & line regulators overload and 313R2 pick-up setting

2029

General Discussion

For 2029, the following new design criteria violations were identified:

- 0 substations have new bus fault violations

Any new events are presented in bold within the following tables.

Central Region

Central Region – Bus Faults with Risk of Isolated Customers (2029)			
Substation	Bus #	Isolated Load (MW)	Notes
Huse Road	Bus 1/2/3	35.1	Limited by 2.13 miles of 266 ACSR from P. 3614/66 (3614J35 Mammoth Road RTU) to P. 3614/130 (393J6 Hanover St). and 3119 Radial line Isolated load reduced to 11.8 MW after 6 load block transfers Isolates 7.9 MW on the 393 Line; 3.9 MW Radial (3119) Recommend reconductoring 3614
Garvins	Bus 1/2	24.7	Isolated UES 374 line. Limited by Oak Hill XFMRs, Penacook-Bridge lines and voltage
Oak Hill	Bus 2	11.3	Limited by Ingalls Rd Regulators (14.1 MW emergency rating) Limited by 336 AL Spacer Madbury-Lee Traffic Circle (3 miles) Limited by 336 ACSR Lee Traffic Circle-Northwood Narrows (15.9 miles) Limited by 266 ACSR Northwood Narrows- Ingalls Rd (7.9 miles) Limited by low voltage on 319 and 3137X lines Load can be restored using 319-3025 manual circuit tie

Eastern Region

Eastern Region – Bus Faults with Risk of Isolated Customers (2029)			
Substation	Bus #	Isolated Load (MW)	Notes
Madbury	Bus 1/2/3	35.4	Limited by 319 line 5.7 miles of 3/0 ACSR (Oak Hill breaker-Ingalls Rd), line regulator overload, low voltage. Isolated load is reduced to 26.3 MW after 4 load block transfers. Bus tie with breakers rearrangement would allow for a complete restoration
Dover	Bus 2	4.9	Limited by voltage. Isolated Somersworth substation. Load can be fully restored in 4 load block transfers
Mill Pond	Bus 1	4.9	Isolated 71W4. Full restoration is possible with utilizing a manual circuit tie

Northern Region

Northern Region – Bus Faults with Risk of Isolated Customers (2029)			
Substation	Bus #	Isolated Load (MW)	Notes
Laconia	Bus 1/2/3	28.1	Limited by 345 line 3.73 miles of 336 ACSR from Pemi breaker to 345X2 TAP and the 310 & 3222 radial lines. Bus Tie breaker installation is recommended.
Whitefield	Bus	17.3	No SCADA controlled circuit ties. Isolated TB1W (1.4 MW) and 348X line (15.9 MW)
Berlin	Bus 1/2	15.9	Limited by voltage on 351. Isolated 3521 line (4.2 MW) and 3525X line (11.7 MW). Installation of line Cap banks may allow to restore entire load
Pemigewasset	Bus	13.3	Limited by low voltage on the 3114X line. Entire load can be restored after 4 load block transfers
North Woodstock	Bus	11.5	Requires system upgrades on NHEC's system to utilize Thornton-North Woodstock circuit tie
Saco Valley	Bus 1/2	9.6	Isolated 395 radial line. Can be restored via manual circuit tie
Webster	Daniel Bus 2	6.1	Limited by manual device (3216J2). Isolated 3193 Radial line feeding NHEC Webster
Lost Nation	Bus 1/2	0.6	Isolated 384 radial line. Recommended to automate the J554 switch

Southern Region

Southern Region – Bus Faults with Risk of Isolated Customers (2029)			
Substation	Bus #	Isolated Load (MW)	Notes
Amherst	Bus 2	16.4	Complete restoration requires 5 load block transfers
Scobie Pond	Bus 1	10.5	Isolated 32W5. Limited by 32W4 conductor size
Hudson	Bus 1/2	10.4	Load can be fully restored in 4 load block transfers
Bridge Street (4 kV)	Bus 1/2	8.0	No SCADA switching on the Nashua 4 kV
Bridge Street (34 kV)	Bus A/B	6.2	Load can be fully restored in 4 load block transfers

Western Region

Western Region – Bus Faults with Risk of Isolated Customers (2029)			
Substation	Bus #	Isolated Load (MW)	Notes
North Road	Bus 1/2	40.0	Limited by 5.85 Miles #2 CU Davisville to Warner, Low voltage on 316 line. Recommended replacing J89 with Bus Tie and Moving 316 to Bus 1. Partially solved with bus tie and 1.8 MVAR cap bank on George Mill tap.
North Keene	Bus 1	6.6	Limited by manual circuit tie and 76W1 4/0 ACSR from North Keene to 192/92 (1.04 miles). Isolated 76W7.
Jackman	Bus 1/2/3	5.8	Limited by 313 voltage & line regulators overload and 313R2 pick-up setting

Appendix A: Contingencies Studied

Region	Substation	Element	Year Studied
Central	Amherst	TB68	2020-2029
Central	Amherst	TB85	2020-2029
Central	Amherst	3143X	2020-2029
Central	Amherst	3159X	2020-2029
Central	Amherst	3212X	2020-2029
Central	Bedford	Bus	2020-2029
Central	Bedford	TB164 or TB191	2020-2029
Central	Bedford	324	2020-2029
Central	Bedford	3142	2020-2029
Central	Bedford	3182	2020-2029
Central	Bedford	3392	2020-2029
Central	Bedford	3467	2020-2029
Central	Bedford	3138X	2020-2029
Central	Brook Street	356	2020-2029
Central	Brook Street	372	2020-2029
Central	Brook Street	388	2020-2029
Central	Brook Street	3673	2020-2029
Central	Brook Street	3248	2020-2029
Central	Canal Street	331	2020-2029
Central	Canal Street	356	2020-2029
Central	Canal Street	357	2020-2029
Central	Canal Street	364	2020-2029
Central	Eddy	TB26 or TB81	2020-2029
Central	Eddy	Bus A	2020-2029
Central	Eddy	Bus B	2020-2029
Central	Eddy	357	2020-2029
Central	Eddy	372	2020-2029
Central	Eddy	358	2020-2029
Central	Eddy	359	2020-2029
Central	Eddy	312 / 387	2020-2029
Central	Garvins	334	2020-2029
Central	Garvins	335	2020-2029
Central	Garvins	318	2020-2029
Central	Garvins	374	2020-2029
Central	Garvins	375	2020-2029
Central	Garvins	396	2020-2029
Central	Huse Road	Bus 2	2020-2029
Central	Huse Road	TB46	2020-2029
Central	Huse Road	TB58	2020-2029
Central	Huse Road	3179	2020-2029
Central	Huse Road	TB58 or TB46	2020-2029
Central	Huse Road	393	2020-2029
Central	Huse Road	3119	2020-2029
Central	Huse Road	3130	2020-2029
Central	Huse Road	321	2020-2029
Central	Huse Road	325	2020-2029
Central	Milford	378	2020-2029
Central	Milford	23X5	2020-2029
Central	Milford	23X6	2020-2029
Central	Pine Hill	TB118 or TB161	2020-2029
Central	Pine Hill	Bus 1	2020-2029
Central	Pine Hill	Bus 2	2020-2029
Central	Pine Hill	3613	2020-2029
Central	Pine Hill	3614	2020-2029
Central	Pine Hill	3615	2020-2029
Central	Reeds Ferry	TB50	2020-2029
Central	Reeds Ferry	Bus	2020-2029
Central	Reeds Ferry	323	2020-2029
Central	Reeds Ferry	3197	2020-2029
Central	Reeds Ferry	3164	2020-2029
Central	Rimmon	Bus 2/328	2020-2029
Central	Rimmon	Bus 1	2020-2029
Central	Rimmon	322	2020-2029
Central	Rimmon	334	2020-2029
Central	Rimmon	335	2020-2029
Central	Rimmon	358	2020-2029
Central	Rimmon	359	2020-2029
Central	Rimmon	3151	2020-2029
Central	South Manchester	Bus	2020-2029
Central	South Manchester	320	2020-2029
Central	South Manchester	325	2020-2029
Central	South Manchester	3142	2020-2029
Central	South Manchester	370X	2020-2029
Central	South State Street	331	2020-2029
Central	South State Street	3190 / Bus	2020-2029
Central	South State Street	19X5	2020-2029

Central	South State Street	19X6	2020-2029
Central	South State Street	312 / 387	2020-2029
Central	Weare	3108	2020-2029
Central	Weare	3271	2020-2029
Central Southern	Broad Street	329	2020-2029
Central Southern	Broad Street	3217X	2020-2029
Central Southern	South Milford	329	2020-2029
Central Southern	South Milford	3217	2020-2029
Eastern	Brentwood	TB126	2020-2029
Eastern	Brentwood	Bus	2020-2029
Eastern	Brentwood	3103	2020-2029
Eastern	Dover / Cocheco Street	TB22	2020-2029
Eastern	Dover / Cocheco Street	TB55	2020-2029
Eastern	Dover / Cocheco Street	32	2020-2029
Eastern	Dover / Cocheco Street	371	2020-2029
Eastern	Dover / Cocheco Street	399	2020-2029
Eastern	Dover / Cocheco Street	3148	2020-2029
Eastern	Great Bay	TB141	2020-2029
Eastern	Great Bay	Bus	2020-2029
Eastern	Great Bay	3260	2020-2029
Eastern	Great Bay	3810X	2020-2029
Eastern	Madbury	TB65	2020-2029
Eastern	Madbury	TB74	2020-2029
Eastern	Madbury	Bus	2020-2029
Eastern	Madbury	380	2020-2029
Eastern	Madbury	3152	2020-2029
Eastern	Madbury	3425	2020-2029
Eastern	Mill Pond	TB171	2020-2029
Eastern	Mill Pond	Bus	2020-2029
Eastern	Mill Pond	71W1	2020-2029
Eastern	Mill Pond	71W2	2020-2029
Eastern	Mill Pond	71W3	2020-2029
Eastern	Mill Pond	71W4	2020-2029
Eastern	Ocean Road	TB181	2020-2029
Eastern	Ocean Road	TB194	2020-2029
Eastern	Ocean Road	Bus	2020-2029
Eastern	Ocean Road	3111	2020-2029
Eastern	Ocean Road	3112	2020-2029

Eastern	Ocean Road	3165	2020-2029
Eastern	Ocean Road	3171	2020-2029
Eastern	Ocean Road	3172	2020-2029
Eastern	Ocean Road	3191	2020-2029
Eastern	Packers Falls	377	2020-2029
Eastern	Packers Falls	380	2020-2029
Eastern	Packers Falls	3152	2020-2029
Eastern	Packers Falls	3162	2020-2029
Eastern	Packers Falls	3229	2020-2029
Eastern	Portland Street	32	2020-2029
Eastern	Portland Street	340	2020-2029
Eastern	Portland Street	371	2020-2029
Eastern	Portland Street	386	2020-2029
Eastern	Portsmouth	TB156	2020-2029
Eastern	Portsmouth	Bus	2020-2029
Eastern	Portsmouth	367	2020-2029
Eastern	Portsmouth	3850	2020-2029
Eastern	Portsmouth	3153X	2020-2029
Eastern	Resistance	TB143	2020-2029
Eastern	Resistance	Bus	2020-2029
Eastern	Resistance	339	2020-2029
Eastern	Resistance	367	2020-2029
Eastern	Resistance	3214	2020-2029
Eastern	Rochester	TB53	2020-2029
Eastern	Rochester	TB57	2020-2029
Eastern	Rochester	Bus A	2020-2029
Eastern	Rochester	Bus B	2020-2029
Eastern	Rochester	340	2020-2029
Eastern	Rochester	362	2020-2029
Eastern	Rochester	386A	2020-2029
Eastern	Rochester	392X	2020-2029
Eastern	Somersworth	32	Not Studied
Eastern	Somersworth	371	Not Studied
Eastern	Tasker Farm	TB78	2020-2029
Eastern	Tasker Farm	Bus	2020-2029
Eastern	Tasker Farm	3157	2020-2029
Eastern	Tasker Farm	3174	2020-2029
Eastern	Tasker Farm	3228	2020-2029
Eastern	Timber Swamp	TB25	2020-2029
Eastern	Timber Swamp	TB69	2020-2029
Eastern	Timber Swamp	Bus 1	2020-2029
Eastern	Timber Swamp	Bus 2	2020-2029
Eastern	Timber Swamp	3112	2020-2029

Eastern	Timber Swamp	3165	2020-2029
Eastern	Timber Swamp	3172	2020-2029
Eastern	Timber Swamp	3360	2020-2029
Eastern	Timber Swamp	3371	2020-2029
Eastern Northern	Madbury	3137X	2020-2029
Northern	Ashland	TB5	2020-2029
Northern	Ashland	Bus	2020-2029
Northern	Ashland	338	2020-2029
Northern	Ashland	3196	2020-2029
Northern	Beebe River	TB62	2020-2029
Northern	Beebe River	Bus	2020-2029
Northern	Beebe River	342A	2020-2029
Northern	Beebe River	342B	2020-2029
Northern	Berlin / Eastside	TB83	2020-2029
Northern	Berlin / Eastside	TB115	2020-2029
Northern	Berlin / Eastside	Bus	2020-2029
Northern	Berlin / Eastside	352	2020-2029
Northern	Berlin / Eastside	3521	2020-2029
Northern	Berlin / Eastside	3525X	2020-2029
Northern	Daniel	Bus 1	2020-2029
Northern	Daniel	Bus 2	2020-2029
Northern	Daniel	3193	2020-2029
Northern	Daniel	3216	2020-2029
Northern	Daniel	3548	2020-2029
Northern	Laconia	TB24	2020-2029
Northern	Laconia	TB125	2020-2029
Northern	Laconia	Bus	2020-2029
Northern	Laconia	310	2020-2029
Northern	Laconia	337	2020-2029
Northern	Laconia	368	2020-2029
Northern	Laconia	398	2020-2029
Northern	Laconia	3222X	2020-2029
Northern	Lost Nation	TB033	2020-2029
Northern	Lost Nation	Bus	2020-2029
Northern	Lost Nation	355	2020-2029
Northern	Lost Nation	376	2020-2029
Northern	Lost Nation	384	2020-2029
Northern	Messer Street	368	Not Studied
Northern	Messer Street	3625	Not Studied
Northern	North Woodstock	TB67	2020-2029
Northern	North Woodstock	Bus	2020-2029

Northern	North Woodstock	3126	2020-2029
Northern	North Woodstock	3822	2020-2029
Northern	Oak Hill	317	2020-2029
Northern	Oak Hill	319	2020-2029
Northern	Oak Hill	3122	2020-2029
Northern	Pemigewasset	TB88	2020-2029
Northern	Pemigewasset	Bus	2020-2029
Northern	Pemigewasset	345	2020-2029
Northern	Pemigewasset	3149	2020-2029
Northern	Pemigewasset	3114X	2020-2029
Northern	Saco Valley	TB60	2020-2029
Northern	Saco Valley	Bus	2020-2029
Northern	Saco Valley	347	2020-2029
Northern	Saco Valley	395	2020-2029
Northern	Saco Valley	333X	2020-2029
Northern	Webster	TB59	2020-2029
Northern	Webster	TB43	2020-2029
Northern	White Lake	TB76	2020-2029
Northern	White Lake	TB82	2020-2029
Northern	White Lake	Bus	2020-2029
Northern	White Lake	346	2020-2029
Northern	White Lake	3181	2020-2029
Northern	White Lake	3218	2020-2029
Northern	White Lake	3116X	2020-2029
Northern	Whitefield	TB89	2020-2029
Northern	Whitefield	Bus	2020-2029
Northern	Whitefield	348	2020-2029
Northern	Whitefield	351	2020-2029
Northern	Whitefield	376	2020-2029
Southern	Amherst	Bus 2	2020-2029
Southern	Amherst	Bus 1	2020-2029
Southern	Amherst	3110X	2020-2029
Southern	Amherst	3445X	2020-2029
Southern	Bridge Street	N124 Transmission	2020-2029
Southern	Bridge Street	Bus A/B	2020-2029
Southern	Bridge Street	TB45 or TB52	2020-2029
Southern	Bridge Street	TB15C	2020-2029
Southern	Bridge Street	353	2020-2029
Southern	Bridge Street	383	2020-2029
Southern	Bridge Street	3891	2020-2029
Southern	Bridge Street	3020X	2020-2029
Southern	Bridge Street	3168X	2020-2029
Southern	Broad Street	3223	2020-2029

southern	Broad Street	3110X	2020-2029
southern	Broad Street	3445X	2020-2029
Southern	Broad Street	353	2020-2029
Southern	Broad Street	3891	2020-2029
Southern	Broad Street	3168X	2020-2029
Southern	Busch	TB121	2020-2029
Southern	Busch	TB122	2020-2029
Southern	Chester	TB131	2020-2029
Southern	Chester	TB71	2020-2029
Southern	Chester	3141X	2020-2029
Southern	Hudson	TB44/33	2020-2029
Southern	Hudson	Bus	2020-2029
Southern	Hudson	383	2020-2029
Southern	Hudson	389	2020-2029
Southern	Hudson	3146	2020-2029
Southern	Hudson	3147	2020-2029
Southern	Hudson	3175X	2020-2029
Southern	Hudson	3211X	2020-2029
Southern	Kingston	TB91	2020-2029
Southern	Kingston	3818	2020-2029
Southern	Lawrence Road	TB48	2020-2029
Southern	Lawrence Road	3133	2020-2029
Southern	Lawrence Road	Bus	2020-2029
Southern	Lawrence Road	TB48	2020-2029
Southern	Lawrence Road	3144	2020-2029
Southern	Lawrence Road	3146	2020-2029
Southern	Lawrence Road	3147	2020-2029
Southern	Lawrence Road	3211X	2020-2029
Southern	Long Hill	Bus / P134 Transmission	2020-2029
Southern	Long Hill	3154	2020-2029
Southern	Long Hill	3136X	2020-2029
Southern	Long Hill	3177X	2020-2029
Southern	Mammoth Rd	365X	2020-2029
Southern	Mammoth Road	3128	2020-2029
Southern	Scobie Pond	TB132	2020-2029
Southern	Scobie Pond	TB232	2020-2029
Southern	Scobie Pond	Transmission	2020-2029
Southern	Scobie Pond	Bus 1	2020-2029
Southern	Scobie Pond	Bus 2	2020-2029
Southern	Scobie Pond	32W1	2020-2029
Southern	Scobie Pond	32W2	2020-2029

Southern	Scobie Pond	32W3	2020-2029
Southern	Scobie Pond	32W4	2020-2029
Southern	Scobie Pond	32W5	2020-2029
Southern	South Milford	TB86	2020-2029
Southern	South Milford	Bus 2	2020-2029
Southern	South Milford	Bus 1	2020-2029
Southern	South Milford	314	2020-2029
Southern	South Milford	378	2020-2029
Southern	South Milford	3155	2020-2029
Southern	South Milford	3143X	2020-2029
Southern	South Milford	3212X	2020-2029
Southern	Thornton	TB77	2020-2029
Southern	Thornton	3750	2020-2029
Southern	Thornton	3010X	2020-2029
Southern	Thornton	3241X	2020-2029
Southern Central	Mammoth Rd	Bus 1	2020-2029
Southern Central	Mammoth Rd	TB16	2020-2029
Southern Central	Mammoth Rd	TB73	2020-2029
Southern Central	Mammoth Rd	3184	2020-2029
Southern Central	Mammoth Road	Bus 2	2020-2029
Southern Eastern	Chester	3115X	2020-2029
Western	Chestnut Hill	3139	2020-2029
Western	Chestnut Hill	3178	2020-2029
Western	Chestnut Hill	TB87	2020-2029
Western	Chestnut Hill	TB98	2020-2029
Western	Chestnut Hill	Bus 1/2	2020-2029
Western	Emerald Street / Keene	Bus 2/W185	2020-2029
Western	Emerald Street / Keene	Bus 1	2020-2029
Western	Emerald Street / Keene	Bus 3	2020-2029
Western	Emerald Street / Keene	TX3	2020-2029
Western	Emerald Street / Keene	TX136	2020-2029
Western	Emerald Street / Keene	TX123	2020-2029
Western	Emerald Street / Keene	W1	2020-2029
Western	Emerald Street / Keene	W110	2020-2029
Western	Emerald Street / Keene	W13	2020-2029
Western	Emerald Street / Keene	W14	2020-2029

Western	Emerald Street / Keene	W9	2020-2029
Western	Emerald Street / Keene	W15	2020-2029
Western	Emerald Street / Keene	W175	2020-2029
Western	Emerald Street / Keene	W2	2020-2029
Western	Jackman	Bus 1	2020-2029
Western	Jackman	TB61	2020-2029
Western	Jackman	TB33	2020-2029
Western	Jackman	3173	2020-2029
Western	Jackman	313	2020-2029
Western	Jackman	3140	2020-2029
Western	Monadnock	Bus 1	2020-2029
Western	Monadnock	Bus 2	2020-2029
Western	Monadnock	TB40/TB80	2020-2029
Western	Monadnock	382	2020-2029
Western	Monadnock	3120	2020-2029

Western	Monadnock	3235	2020-2029
Western	North Keene	76W1	2020-2029
Western	North Keene	76W3	2020-2029
Western	North Keene	76W4	2020-2029
Western	North Keene	76W5	2020-2029
Western	North Keene	76W7/TB148/Bus 2	2020-2029
Western	North Road	Bus	2020-2029
Western	North Road	315	2020-2029
Western	North Road	316	2020-2029
Western	North Road	3410	2020-2029
Western	Oak Hill	TB84	2020-2029
Western	Oak Hill	TB15	2020-2029
Western	Oak Hill	319/Bus 1	2020-2029
Western	Oak Hill	317	2020-2029
Western	Oak Hill	317	2020-2029
Western Central	Jackman	311	2020-2029

2020 DESIGN VIOLATIONS SUMMARY REPORT

New Hampshire Distribution System Planning

Cosgro, Matthew D
Senior Engineer, Distribution System Planning – New Hampshire
January 8, 2021, revised March 18, 2021

Contents

System Planning Design Criteria and Violations	3
BULK SUBSTATIONS – CENTRAL REGION	4
Bedford	5
Eddy	8
Garvins	11
Huse Road	14
Pine Hill	17
Rimmon.....	20
BULK SUBSTATIONS – EASTERN REGION	23
Cocheco Street (Dover).....	24
Great Bay.....	27
Madbury.....	30
Mill Pond.....	33
Rochester.....	36
BULK SUBSTATIONS – NORTHERN REGION	39
Ashland	40
Beebe River	43
Berlin (Eastside)	46
Laconia	49
Lost Nation	52
North Woodstock.....	55
Oak Hill	58
Pemigewasset	61
Saco Valley	64
Webster and Daniel	67
White Lake	70
Whitefield	73
BULK SUBSTATIONS – SOUTHERN REGION.....	76
Amherst.....	77
Bridge Street	80
Bridge Street 4kV	84
Hudson	87

Lawrence Road..... 90

Long Hill..... 93

Scobie Pond..... 96

South Milford 100

BULK SUBSTATIONS – WESTERN REGION 103

 Chestnut Hill..... 104

 Emerald Street (Keene)..... 107

 Jackman..... 110

 Monadnock 113

 North Keene 116

 North Road..... 119

NON-BULK SUBSTATIONS 122

 Cutts Street 15W4..... 123

 Goffstown 27W2 126

 Goffstown 45H1 129

 Hanover Street 16W3 132

 Loudon 31W1..... 135

 Loudon 31W2..... 138

 Meetinghouse Road 3W2 141

 Opechee Bay TB10 144

 Rye 48H1 147

 Salmon Falls 51H1 150

 Suncook 44W2 153

 Weirs 156

Appendix A: Determining Solution Milestones..... 157

System Planning Design Criteria and Violations

The bulk substations and non-bulk transformers included in this report are those that have been identified of being in violation of the criteria set forth in the Distribution System Planning Guide published in September 2020 or is a location where a solution to a design violation is being constructed.

Summarizing the Planning Guide, the criteria are as follows. This shorthand nomenclature continues throughout this report.

N-0 Base Load

Bulk Substation – Transformer loading shall not exceed 75% of top nameplate.

Non-bulk Substation – Transformer loading shall not exceed 100% of top nameplate.

N-1 Transformer

For loss of a bulk transformer, all load shall be restored (Load < LCC).

N-1 STE

For loss of a bulk transformer, substation load shall not exceed the STE rating(s) of the remaining transformer(s) (Load < STE_{N-1 min})

N-1 Bus

For a bus fault within a bulk substation, all load shall be restored.

N-1 Bus Tie

For a bus tie breaker failure within a bulk substation, all load shall be restored.

N-1 Transmission

A single contingency on the transmissions system shall not cause a contingency greater than N-1 at a bulk distribution substation.

Load restoration is limited to three load blocks and cascading load (transferring unaffected load to increase restoration capacity) is permitted. With the bus tie design violation, the violation typically appears due to the breaker failure isolating more than three feeders. Bus faults appear as a violation because of system capacity limitations and/or exceeding the permitted load block transfers.

Analysis of the distribution system in this report was based on transformer nameplate data, the 2020-2029 New Hampshire Load Forecast, and results of the 2020-2029 Load Flow Study.

Proposed solutions are tentative and are subject to further study by System Planning and review by the Solution Design Committee. This document is updated accordingly as solutions and timelines evolve.

New Hampshire Design Violations Summary Report

BULK SUBSTATIONS – CENTRAL REGION

REDACTED

New Hampshire Design Violations Summary Report

Bedford

49 Station Road, Bedford, NH

Bedford Substation is a 115-34.5 kV open-air bulk substation with two 44.8 MVA transformers and seven distribution feeders. The distribution bus is operated with an open bus tie breaker.

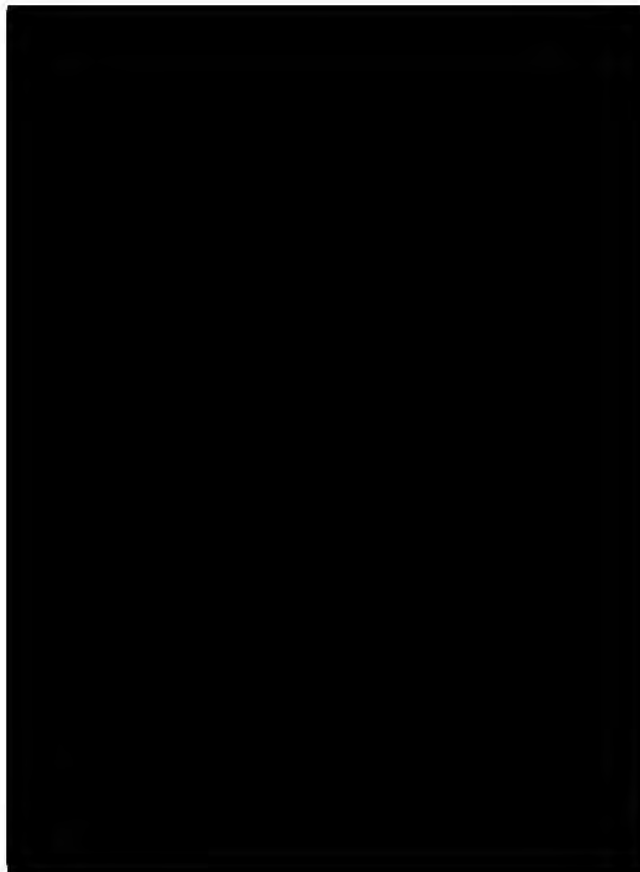
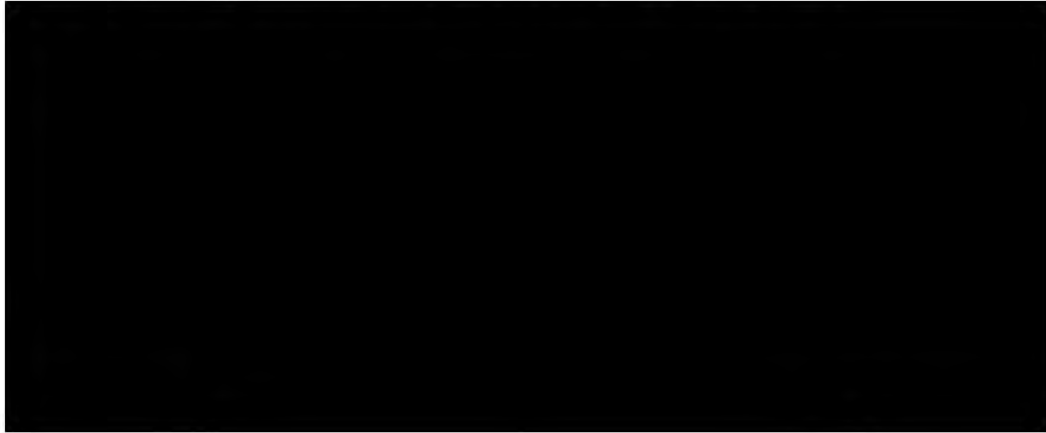

New Hampshire Design Violations Summary Report

Loading and Capacity

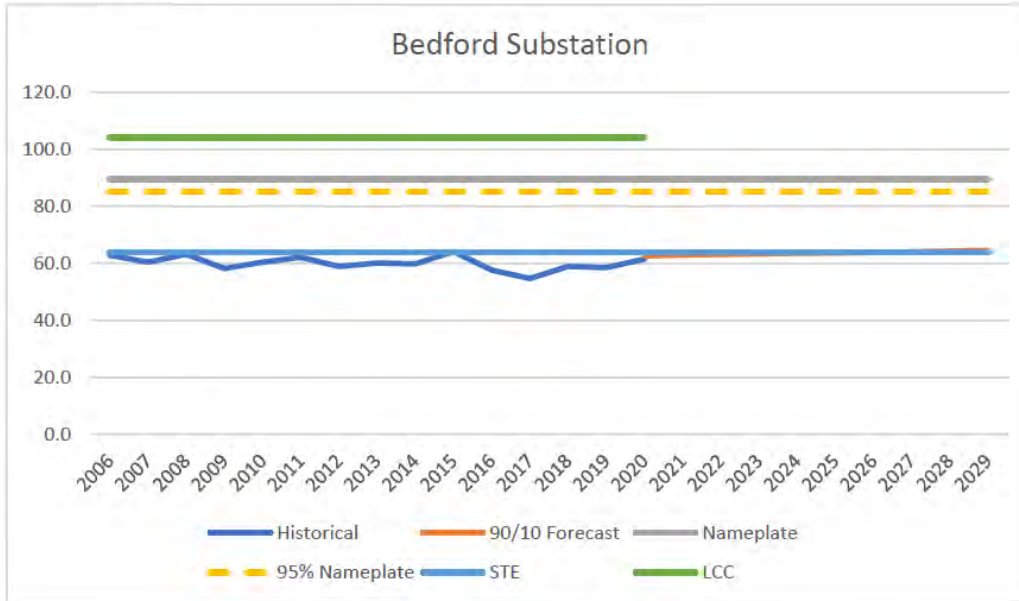

Distribution Company	Customers
Eversource Energy	13,319
Total Customers	13,319

	Mfg. Year	Condition Code ¹	Nameplate	LTE	STE ²	LCC
TB164	2004	1 – Green	44.8	54	64	
TB191	2004	1 – Green	44.8	54	65	
Substation			89.6		64	104.3

Note 1: Transformer condition code as of May 2020.

Note 2: Automatic bus restoral scheme, BT96 auto closes based on seasonal limits.

System Planning Violations & Needs

	N-0 Base Load	N-1 Transformer	N-1 STE	N-1 Bus	N-1 Bus Tie	N-1 Transmission
First Year	10+	10+	2020	10+	2020	n/a
Deficit	None	None	2.6 MW	None		n/a

Solution – Transformer Replacement

In-Service Date: June 1, 2027

- Replace the existing transformers at Bedford Substation with two 62.5 MVA units to address N-1 STE design violation.
- Dependent upon final system configuration of the Manchester area, series bus tie breakers may be needed.

Circuit reconfigurations to reduce loading at Bedford cause STE violations at adjacent stations.

	Planning Study	Initial Funding	SDC Presentation	SDC Approval	EPAC Full Funding
Planned	Manchester Area 6/1/2021	3/1/2021	4/1/2024	5/1/2024	5/1/2025
Actual					

REDACTED

New Hampshire Design Violations Summary Report

Eddy

6 Fletcher Street, Manchester, NH

Eddy Substation is a 115-34.5 kV open-air bulk substation with two 44.8 MVA transformers and six distribution feeders. Of the six feeders, three serve customer load, two are express lines to Rimmon, and one is a feeder to Amoskeag Hydro. The distribution bus is operated with a closed bus tie breaker.



New Hampshire Design Violations Summary Report

Loading and Capacity

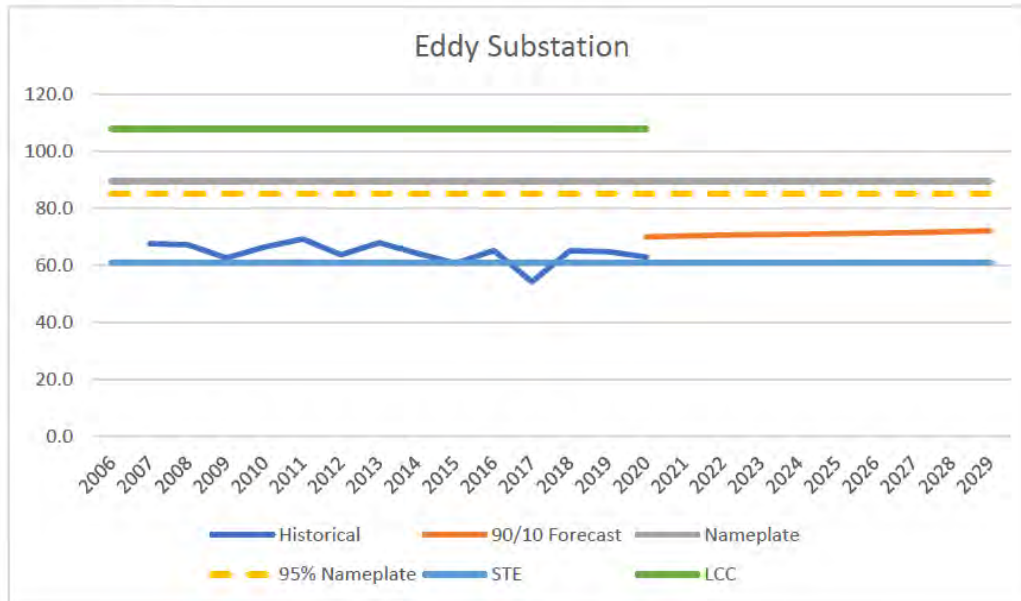

Distribution Company	Customers
Eversource Energy	22,410
Total Customers	22,410

	Mfg. Year	Condition Code ¹	Nameplate	LTE	STE ²	LCC
TB26	1978	2 – Yellow	44.8	54	61	
TB81	1968	2 – Yellow	44.8	56	62	
Substation			89.6		61	108.0

Note 1: Transformer condition code as of May 2020.

Note 2: A transformer protection scheme is being added in 2020/2021 as part of the new control house project. Feeder load-shed is initiated dependent upon seasonal limits.

System Planning Violations & Needs

	N-0 Base Load	N-1 Transformer	N-1 STE	N-1 Bus	N-1 Bus Tie	N-1 Transmission
First Year	10+	10+	2020	10+	2020	n/a
Deficit	None	None	3.0 MW	None		n/a

Solution – Manchester Area Solution

In-Service Date: June 1, 2027

Solution to be determined within Manchester Area Planning Study. Preliminary assumption is larger transformers at Bedford and Huse Road Substations. Dependent upon final system configuration, series bus tie breakers may be needed.

Circuit reconfigurations to reduce loading cause STE violations at adjacent stations.

	Planning Study	Initial Funding	SDC Presentation	SDC Approval	EPAC Full Funding
Planned	Manchester Area 6/1/2021	3/1/2021	4/1/2024	5/1/2024	5/1/2025
Actual					

REDACTED

New Hampshire Design Violations Summary Report

Garvins

4 Garvins Falls Road, Bow, NH

Garvins Substation is a 115-34.5 kV open-air bulk substation with two 67.2 MVA transformers and seven distribution feeders. Of the seven feeders, three serve Eversource customers, three serve Unitil customers, and one is a feeder to Garvins Falls Hydro. The distribution bus is operated as a single straight bus.

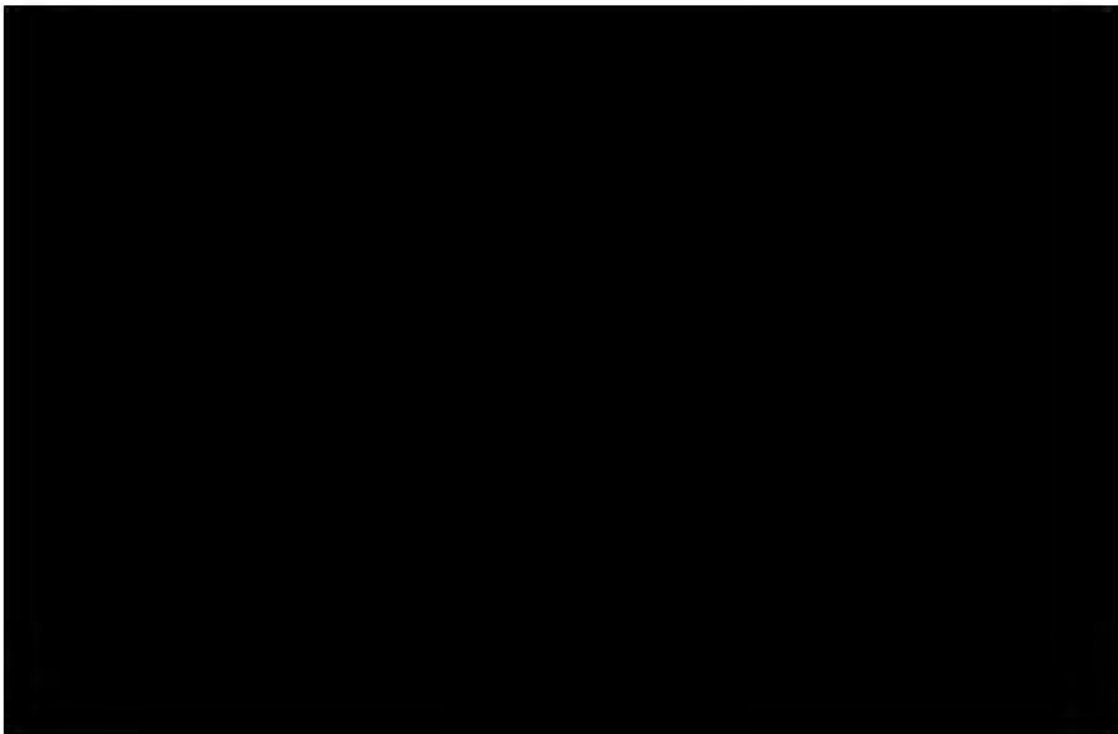
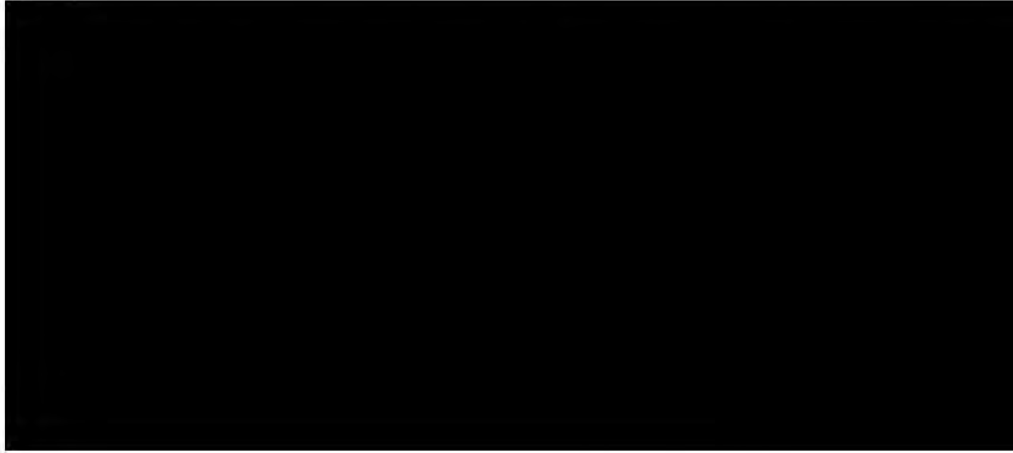

New Hampshire Design Violations Summary Report

Loading and Capacity

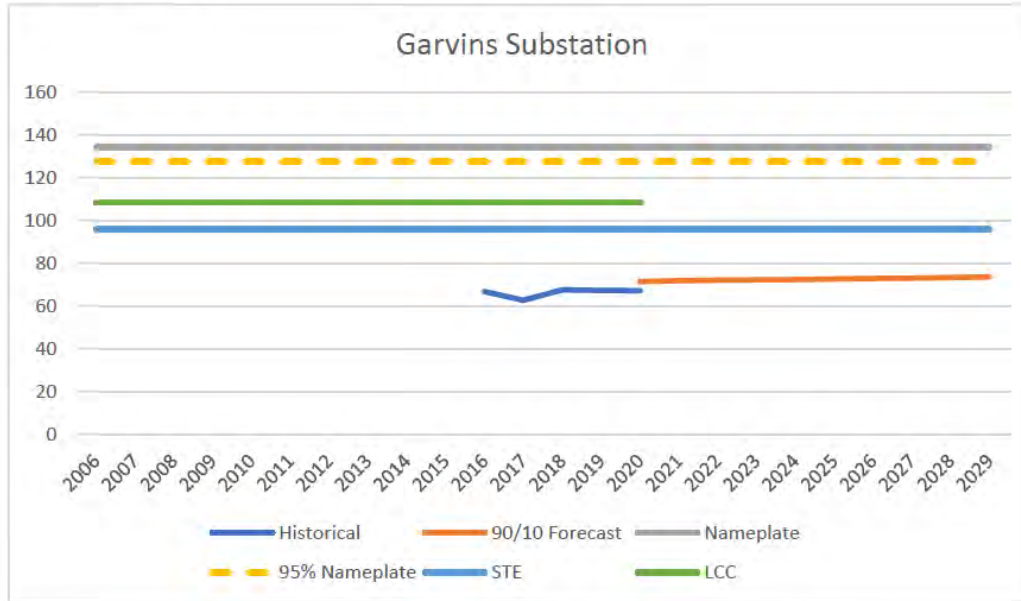

Distribution Company	Customers
Eversource Energy	5,863
Unitil Energy Systems	14,532
Total Customers	20,395

	Mfg. Year	Condition Code ¹	Nameplate	LTE	STE ²	LCC
TB39	1974	2 – Yellow	67.2	81	96	
TB51	1974	1 – Green	67.2	81	96	
Substation			134.4		96	108.0

Note 1: Transformer condition code as of May 2020.

Note 2: Transformer protection scheme sheds feeders 318, 334 and 335.

System Planning Violations & Needs

	N-0 Base Load	N-1 Transformer	N-1 STE	N-1 Bus	N-1 Bus Tie	N-1 Transmission
First Year	10+	10+	10+	2020	n/a	n/a
Deficit	None	None	None	23.9 MW	n/a	n/a

Solution

In-Service Date: June 1, 2024

Joint Planning Study to be initiated with Unitil in 2021.

- Add series bus tie breakers to address N-1 Bus Fault design violation.

	Planning Study	Initial Funding	SDC Presentation	SDC Approval	EPAC Full Funding
Planned	Eversource-UES Joint Planning Study 1/31/2022	3/1/2021	4/1/2022	5/1/2022	5/1/2023
Actual					

REDACTED

New Hampshire Design Violations Summary Report

Huse Road

607 Huse Road, Manchester, NH

Huse Road Substation is a 115-34.5 kV open-air bulk substation with a 44.8 MVA and a 48 MVA transformers and five distribution feeders. The distribution bus is operated as a single straight bus.



New Hampshire Design Violations Summary Report

Loading and Capacity

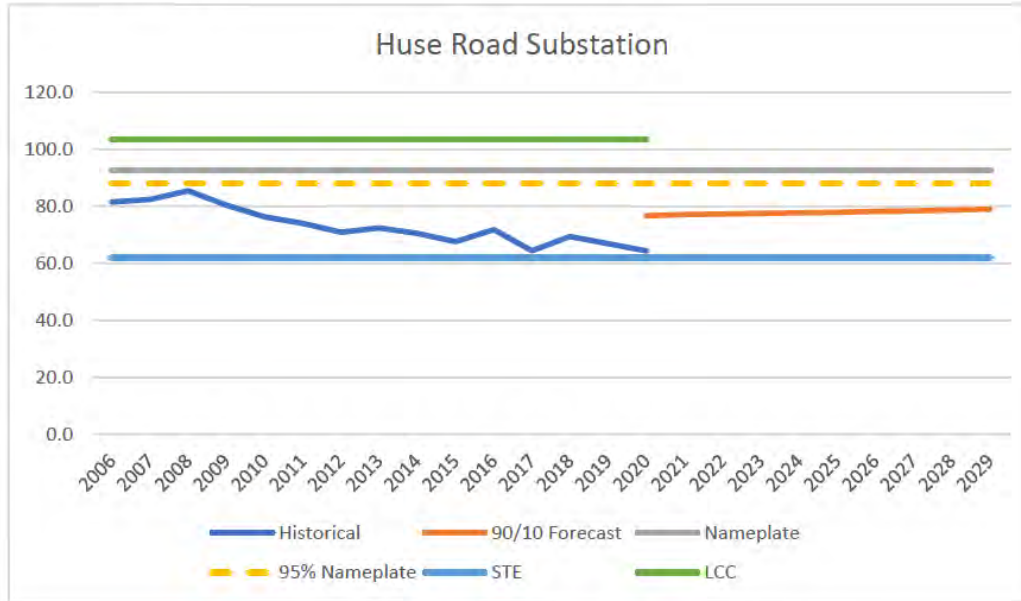

Distribution Company	Customers
Eversource Energy	11,300
Total Customers	11,300

	Mfg. Year	Condition Code ¹	Nameplate	LTE	STE ²	LCC
TB46	1987	1 – Green	48.0	58	69	
TB58	1969	2 – Yellow	44.8	56	62	
Substation			92.8		62	103.6

Note 1: Transformer condition code as of May 2020.

Note 2: Transformer protection scheme sheds feeder load when station load exceeds 70 MVA.

System Planning Violations & Needs

	N-0 Base Load	N-1 Transformer	N-1 STE	N-1 Bus	N-1 Bus Tie	N-1 Transmission
First Year	10+	10+	2020	2020	n/a	n/a
Deficit	None	None	10.7 MW	34.2 MW	n/a	n/a

Solution – Transformer Replacement

In-Service Date: June 1, 2027

- Replace the existing transformers at Huse Road Substation with two 62.5 MVA units to address N-1 STE design violation.
- Add series bus tie breakers to address N-1 Bus Fault design violation.

Circuit reconfigurations to reduce loading at Huse Road cause STE violations at adjacent stations.

	Planning Study	Initial Funding	SDC Presentation	SDC Approval	EPAC Full Funding
Planned	Manchester Area 6/1/2021	3/1/2021	4/1/2024	5/1/2024	5/1/2025
Actual					

REDACTED

New Hampshire Design Violations Summary Report

Pine Hill

7 Legends Drive, Hooksett, NH

Pine Hill Substation is a 115-34.5 kV open-air bulk substation with two 44.8 MVA transformers and four distribution feeders (three serving load, fourth is a spare position). The distribution bus is operated with an open bus tie breaker.

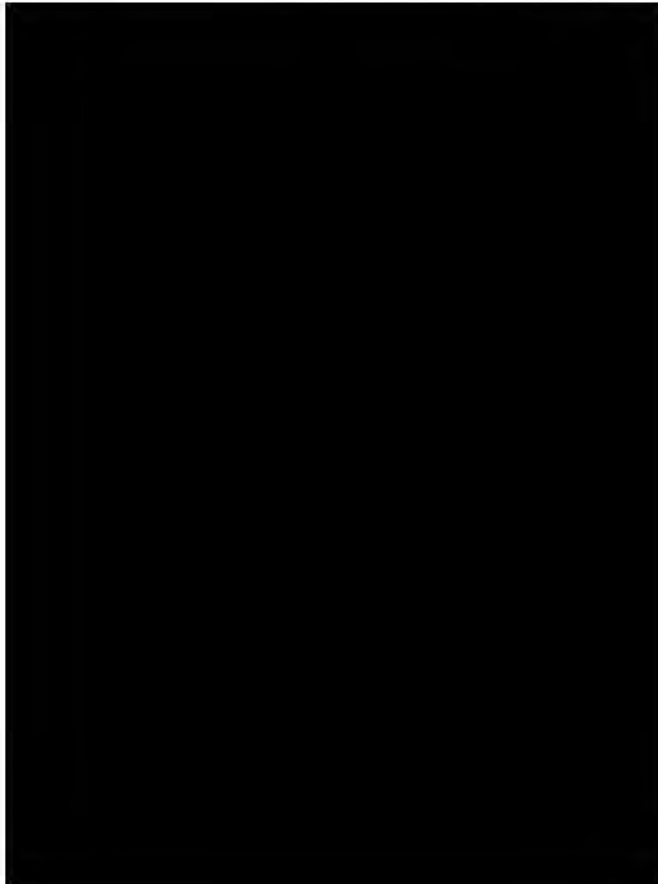

New Hampshire Design Violations Summary Report

Loading and Capacity

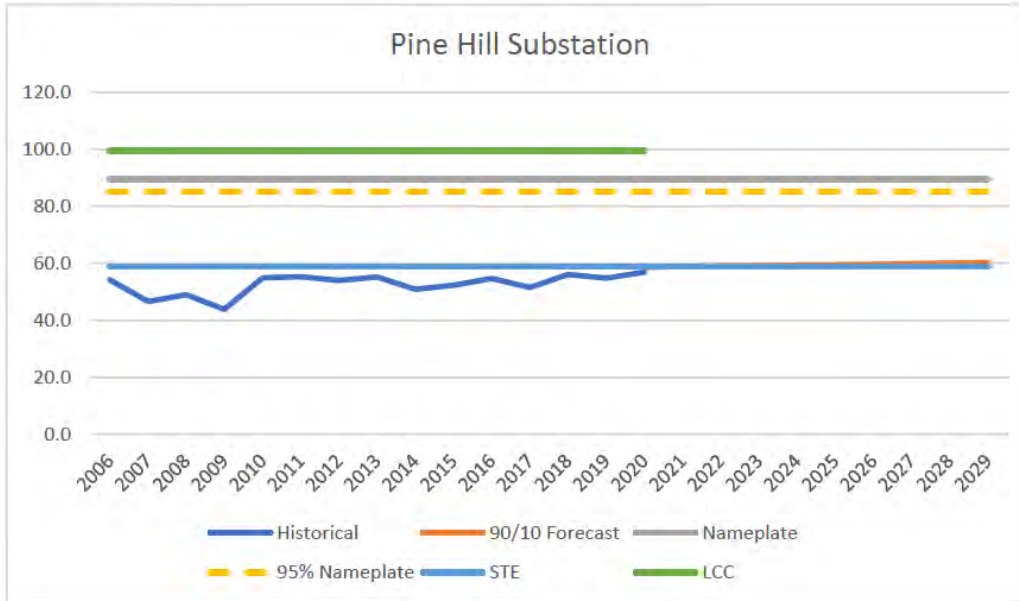

Distribution Company	Customers
Eversource Energy	16,150
Total Customers	16,150

	Mfg. Year	Condition Code ¹	Nameplate	LTE	STE ²	LCC
TB118	2003	1 – Green	44.8	54	66	
TB161	1968	1 – Green	44.8	55	59	
Substation			89.6		59	99.6

Note 1: Transformer condition code as of May 2020.

Note 2: Automatic bus restoral scheme, BT81 auto closes based on seasonal limits.

System Planning Violations & Needs

	N-0 Base Load	N-1 Transformer	N-1 STE	N-1 Bus	N-1 Bus Tie	N-1 Transmission
First Year	10+	10+	2020	10+	2020	n/a
Deficit	None	None	0.2 MW	None		n/a

Solution – Manchester Area Solution

In-Service Date: June 1, 2027

Solution to be determined within Manchester Area Planning Study. Preliminary assumption is larger transformers at Bedford and Huse Road Substations. Dependent upon final system configuration, series bus tie breakers may be needed.

Circuit reconfigurations to reduce loading cause STE violations at adjacent stations.

	Planning Study	Initial Funding	SDC Presentation	SDC Approval	EPAC Full Funding
Planned	Manchester Area 6/1/2021	3/1/2021	4/1/2024	5/1/2024	5/1/2025
Actual					

REDACTED

New Hampshire Design Violations Summary Report

Rimmon

10 Riverview Park Road, Goffstown, NH

Rimmon Substation is a 115-34.5 kV open-air bulk substation with two 44.8 MVA transformers and seven distribution feeders. Of the seven feeders, five serve customer load and two are express lines to Eddy. The distribution bus is operated with an open bus tie breaker.



New Hampshire Design Violations Summary Report

Loading and Capacity

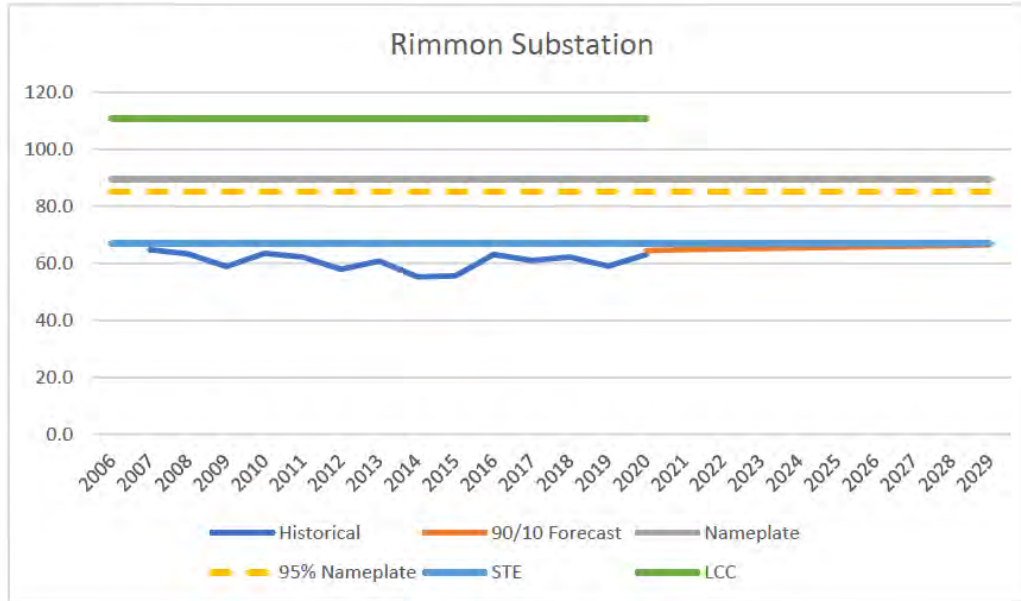

Distribution Company	Customers
Eversource Energy	20,600
Total Customers	20,600

	Mfg. Year	Condition Code ¹	Nameplate	LTE	STE ²	LCC
TB26	2015	1 – Green	44.8	55	67	
TB81	2015	1 – Green	44.8	55	67	
Substation			89.6		67	110.94

Note 1: Transformer condition code as of May 2020.

Note 2: Automatic bus restoral scheme, BT73 auto closes based on seasonal limits.

System Planning Violations & Needs

	N-0 Base Load	N-1 Transformer	N-1 STE	N-1 Bus	N-1 Bus Tie	N-1 Transmission
First Year	10+	10+	10+	10+	2020	n/a
Deficit	None	None	None	None		n/a

Solution – Manchester Area Solution

In-Service Date: June 1, 2027

Solution to be determined within Manchester Area Planning Study. Preliminary assumption is larger transformers at Bedford and Huse Road Substations. Dependent upon final system configuration, series bus tie breakers may be needed.

Circuit reconfigurations to reduce loading cause STE violations at adjacent stations.

	Planning Study	Initial Funding	SDC Presentation	SDC Approval	EPAC Full Funding
Planned	Manchester Area 6/1/2021	3/1/2021	4/1/2024	5/1/2024	5/1/2025
Actual					

New Hampshire Design Violations Summary Report

BULK SUBSTATIONS – EASTERN REGION

REDACTED

Cocheco Street (Dover)

75 Cocheco Street, Dover, NH

Cocheco Street Substation (formerly known as Dover) is a 115-34.5 kV open-air bulk substation with two 44.8 MVA transformers and four distribution feeders. The distribution bus is operated as a single bus. Substation controls are located across the street from the substation yard in a c.1905 powerhouse built by the Dover Gas Light Company.

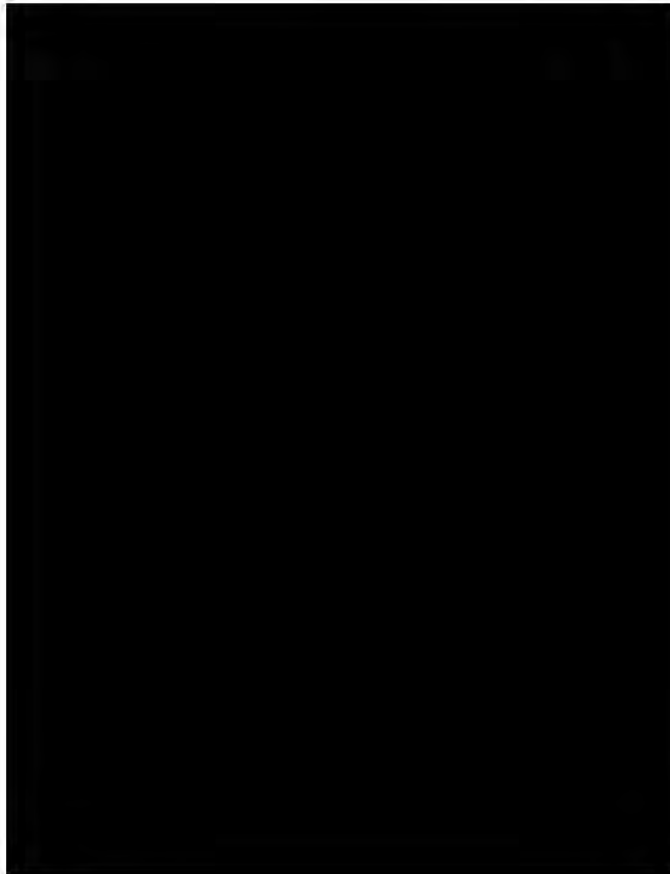
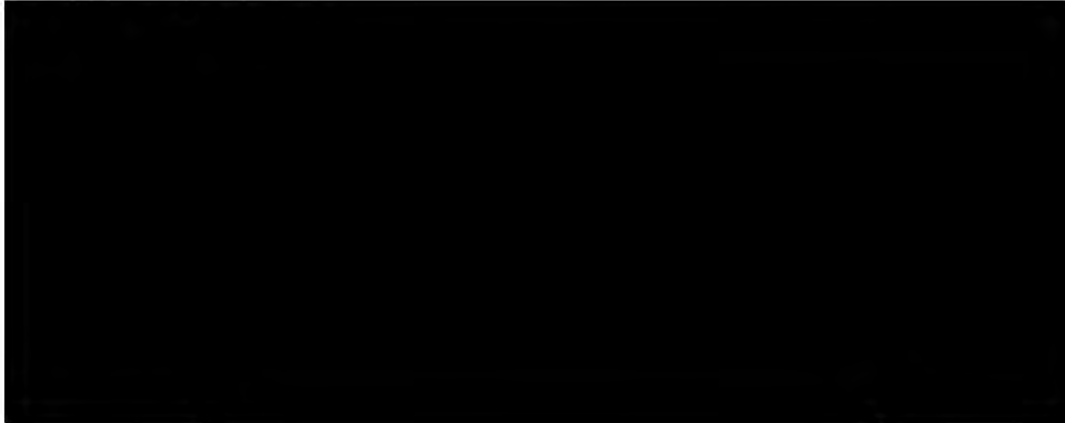

New Hampshire Design Violations Summary Report

Loading and Capacity

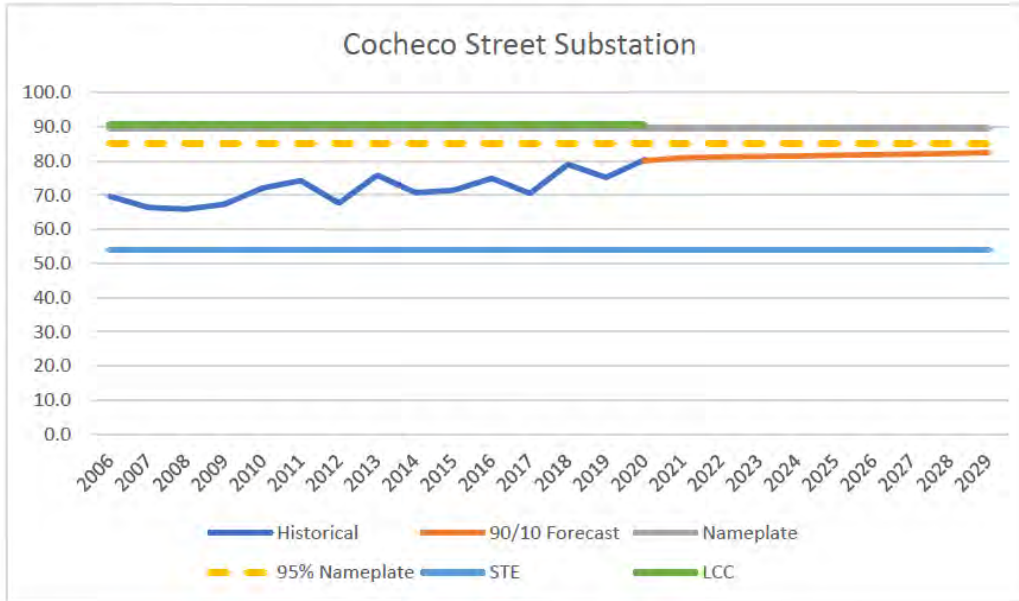

Distribution Company	Customers
Eversource Energy	24,884
Total Customers	24,884

	Mfg. Year	Condition Code ¹	Nameplate	LTE	STE ²	LCC
TB22	1972	2 – Yellow	44.8	51	54	
TB55	2001	1 – Green	44.8	53	61	
Substation			89.6		54	90.6

Note 1: Transformer condition code as of May 2020.

Note 2: A transformer protection scheme load-sheds the 399 line is disabled.

System Planning Violations & Needs

	N-0 Base Load	N-1 Transformer	N-1 STE	N-1 Bus	N-1 Bus Tie	N-1 Transmission
First Year	10+	10+	2020	2020	n/a	n/a
Deficit	None	None	26.1 MW	40.5 MW	n/a	n/a

Solution – Transformer Replacement (D: A18E04, T: T1401A)

In-Service Date: June 1, 2024

- Replace the existing transformers at Cocheco Street Substation with two 62.5 MVA units to address N-1 STE design violation.
- Add series bus tie breakers to address N-1 Bus Fault design violation.

Circuit reconfigurations to reduce loading at Cocheco Street cause STE violations at adjacent stations.

	Planning Study	Initial Funding	SDC Presentation	SDC Approval	EPAC Full Funding
Planned	N/A	N/A	10/1/2021	11/1/2021	11/1/2022
Actual		8/15/2019			

REDACTED

New Hampshire Design Violations Summary Report

Great Bay

3 Grace Lane, Stratham, NH

Great Bay Substation is a 115-34.5 kV open-air bulk substation with a single 44.8 MVA transformer and two distribution feeders. The distribution bus is operated as a single straight bus.

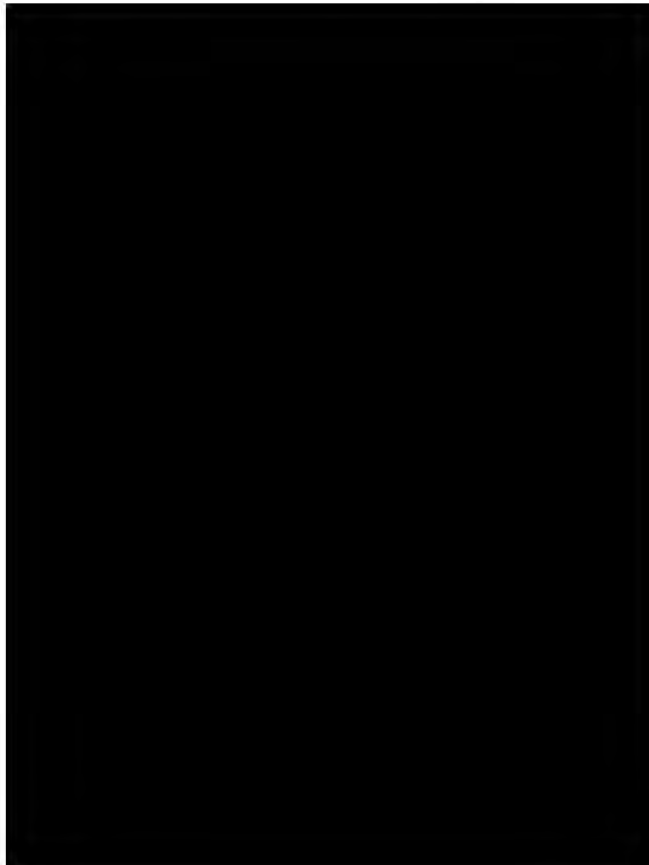
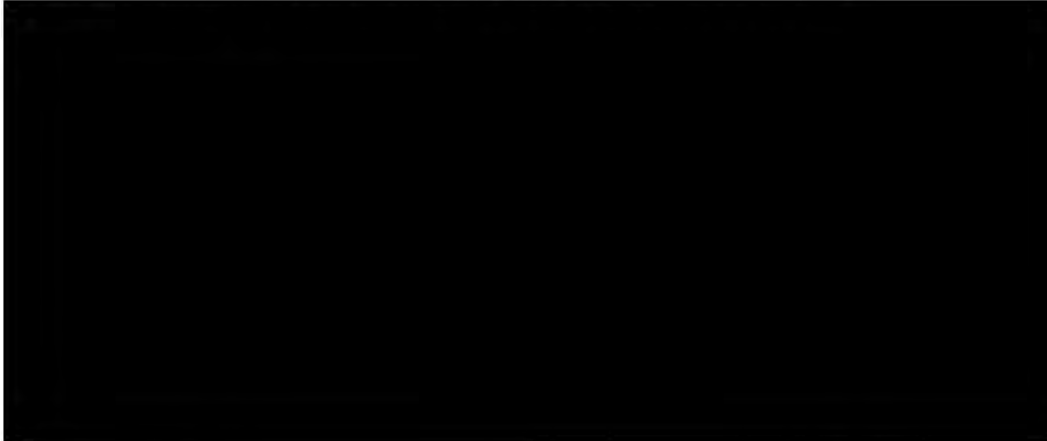

New Hampshire Design Violations Summary Report

Loading and Capacity

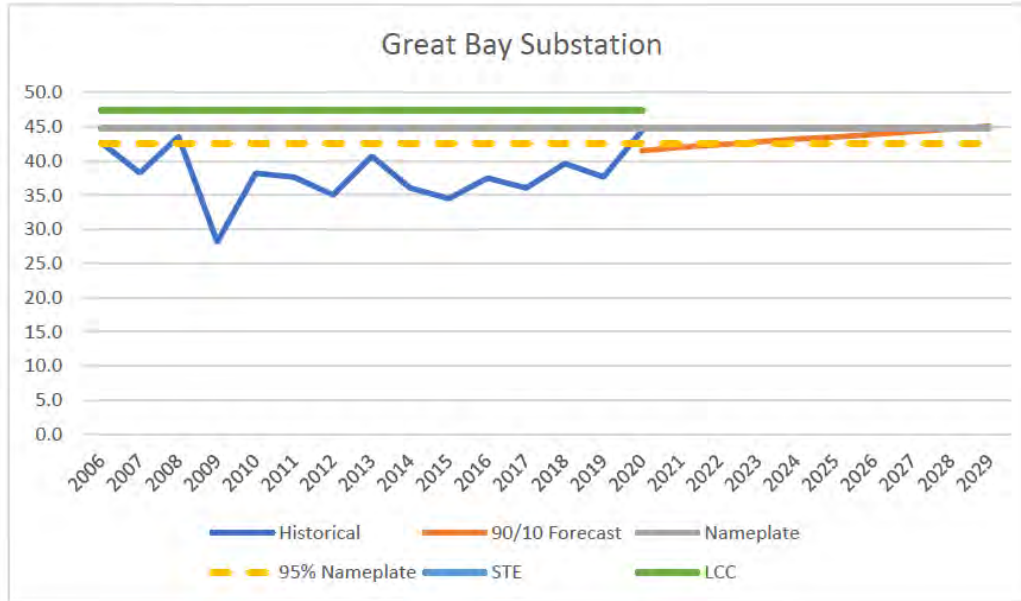

Distribution Company	Customers
Unitil Energy Systems	10,991
Total Customers	10,991

	Mfg. Year	Condition Code ¹	Nameplate	LTE	STE	LCC
TB171	2002	1 – Green	44.8	52	67	
Substation			44.8			47.4

Note 1: Transformer condition code as of May 2020.

System Planning Violations & Needs

	N-0 Base Load	N-1 Transformer	N-1 STE	N-1 Bus	N-1 Bus Tie	N-1 Transmission
First Year	2023	10+	n/a	10+	n/a	n/a
Deficit	0.24 MW	None	n/a	None	n/a	n/a

Solution – Load Transfer

In-Service Date: June 1, 2020

- Transfer load to Timber Swamp Substation to reduce loading on Great Bay to address the base case loading violation.
 - Unitil chooses to perform this seasonally as needed.

REDACTED

New Hampshire Design Violations Summary Report

Madbury

7 Miles Lane, Madbury, NH

Madbury Substation is a 115-34.5 kV open-air bulk substation with two 44.8 MVA transformers and four distribution feeders. The distribution bus is operated as a single bus.

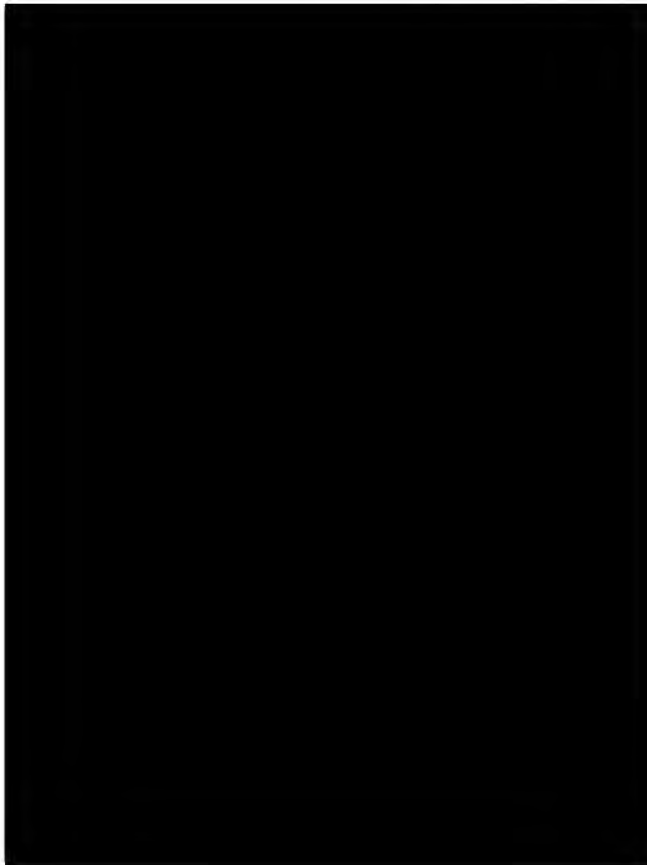
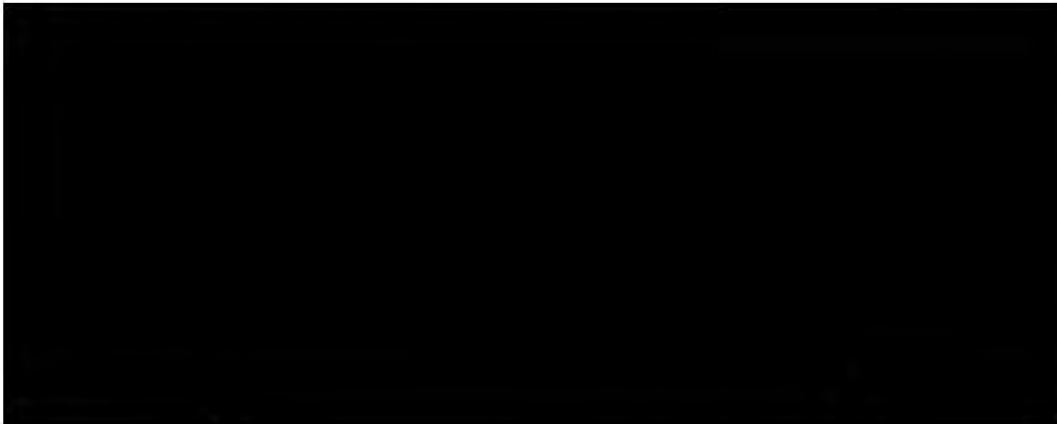

New Hampshire Design Violations Summary Report

Loading and Capacity

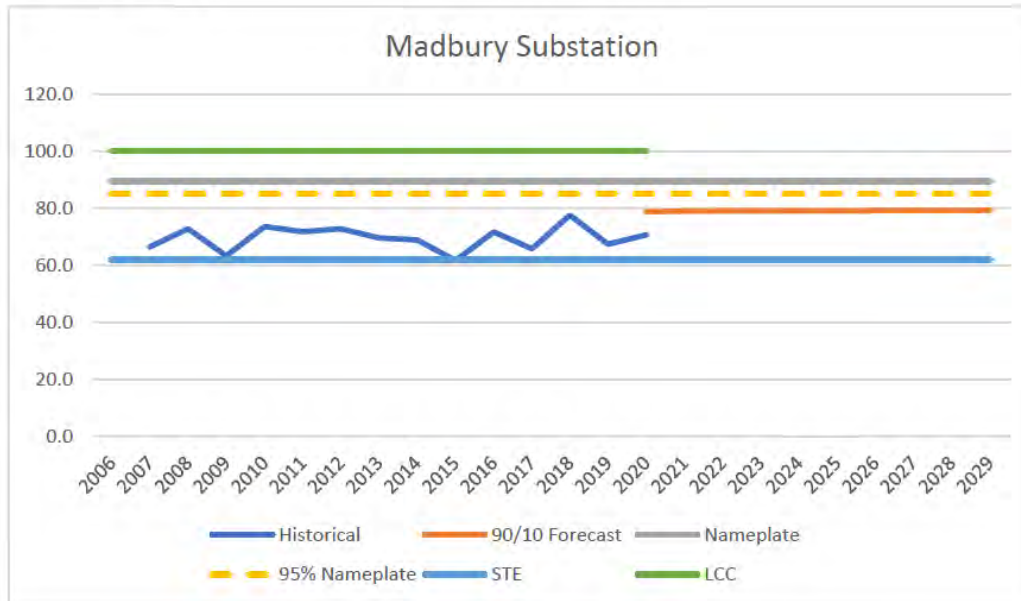

Distribution Company	Customers
Eversource Energy	25,367
New Hampshire Electric Cooperative	2,138
Total Customers	27,505

	Mfg. Year	Condition Code ¹	Nameplate	LTE	STE ²	LCC
TB65	1971	2 – Yellow	44.8	56	62	
TB74	1976	1 – Green	44.8	54	64	
Substation			89.6		62	100.3

Note 1: Transformer condition code as of May 2020.

Note 2: The transformer protection scheme load-sheds the 3173 and 3425 lines but is not functional. Protection scheme initiates with loss of both transformers – dating back to when the 34.5 kV system was operating non-radial feeders.

System Planning Violations & Needs

	N-0 Base Load	N-1 Transformer	N-1 STE	N-1 Bus	N-1 Bus Tie	N-1 Transmission
First Year	10+	10+	2020	2020	n/a	n/a
Deficit	None	None	16.9 MW	35.4 MW	n/a	n/a

Solution – Transformer Replacement

In-Service Date: June 1, 2025

- Replace the existing transformers at Madbury Substation with two 62.5 MVA units to address N-1 STE design violation.
- Add series bus tie breakers to address N-1 Bus Fault design violation.
- Add a new feeder to address loading on the 3137 line.

Circuit reconfigurations to reduce loading at Madbury cause reliability issues with transferring load to Brentwood and Ocean Road Substations.

A solution of adding transformer and feeder capacity at Madbury Substation addresses not only design violations at Madbury, but positively impacts neighboring stations by increasing their LCC capacity. This resolves N-1 violations at Oak Hill Substation.

	Planning Study	Initial Funding	SDC Presentation	SDC Approval	EPAC Full Funding
Planned	Madbury 1/30/2021	3/1/2021	4/1/2022	5/1/2022	5/1/2023
Actual					

REDACTED

New Hampshire Design Violations Summary Report

Mill Pond

445 Route 1 Bypass, Portsmouth, NH

Mill Pond Substation is a 115-12.47 kV switchgear bulk substation with a single 30 MVA transformer and four distribution feeders, three of which serve customer load. The distribution bus is operated as a single straight bus.

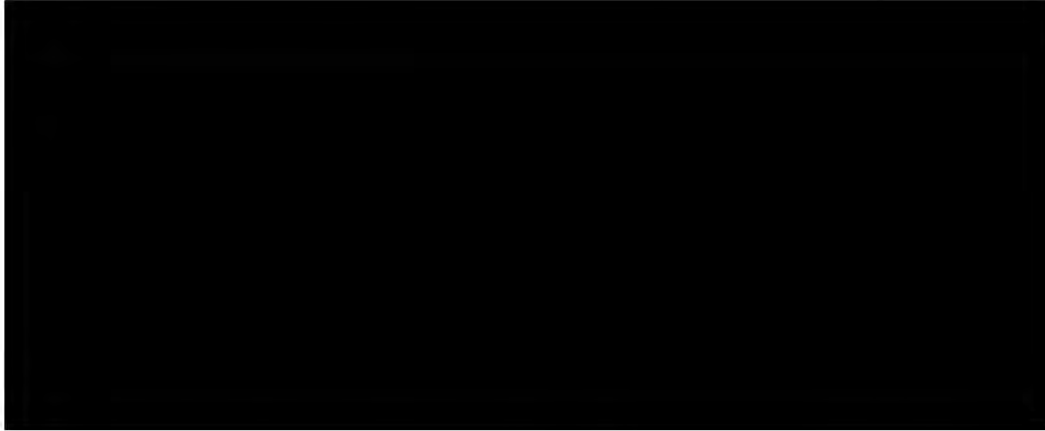

New Hampshire Design Violations Summary Report

Loading and Capacity

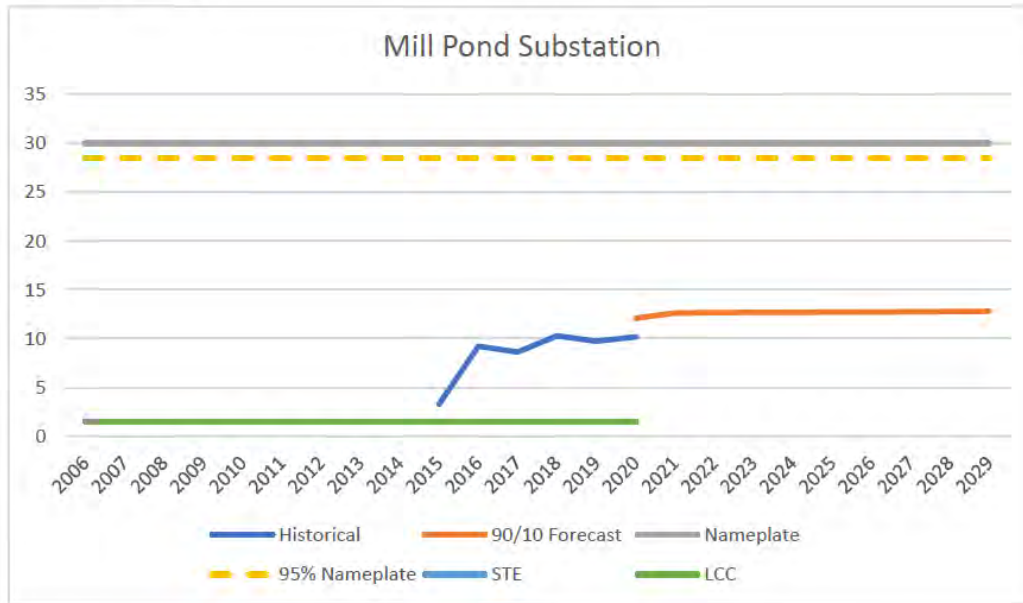

Distribution Company	Customers
Eversource Energy	4,245
Total Customers	4,245

	Mfg. Year	Condition Code ¹	Nameplate	LTE	STE	LCC
TB171	2014	1 – Green	30.0	34.0	45.0	
Substation			30.0			1.5

Note 1: Transformer condition code as of May 2020.

System Planning Violations & Needs

	N-0 Base Load	N-1 Transformer	N-1 STE	N-1 Bus	N-1 Bus Tie	N-1 Transmission
First Year	10+	2020	n/a	2020	n/a	n/a
Deficit	None	10.6 MW	n/a	10.6 MW	n/a	n/a

Solution – Cutts Street Transformer Replacement

Replace transformer at Cutts Street Substation and upgrade distribution lines increasing LCC. See [Cutts Street Substation](#) for details.

REDACTED

Rochester

103 Walnut Street, Rochester, NH

Rochester Substation is a 115-34.5 kV open-air bulk substation with two 44.8 MVA transformers and four distribution feeders. The distribution bus is operated with a normally open bus tie.

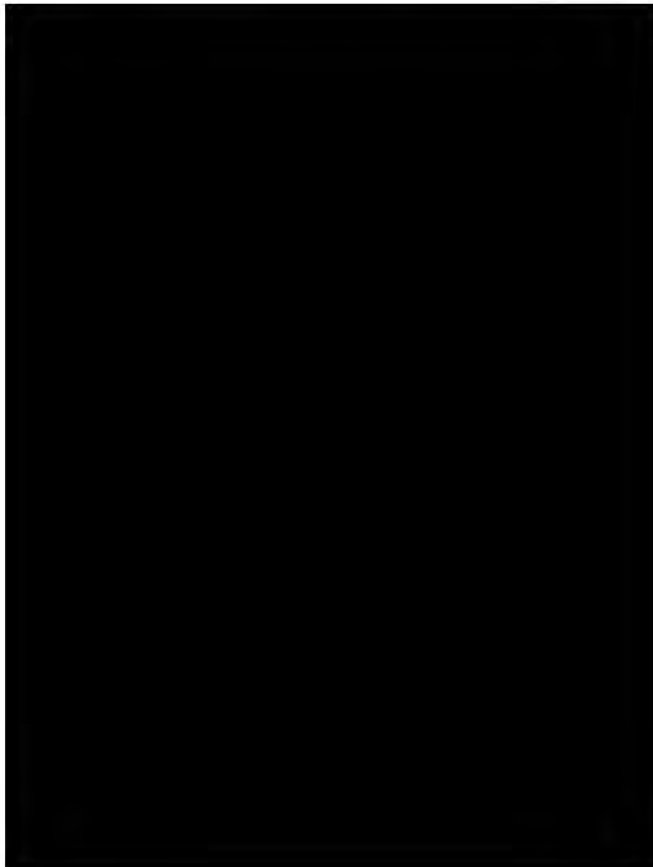
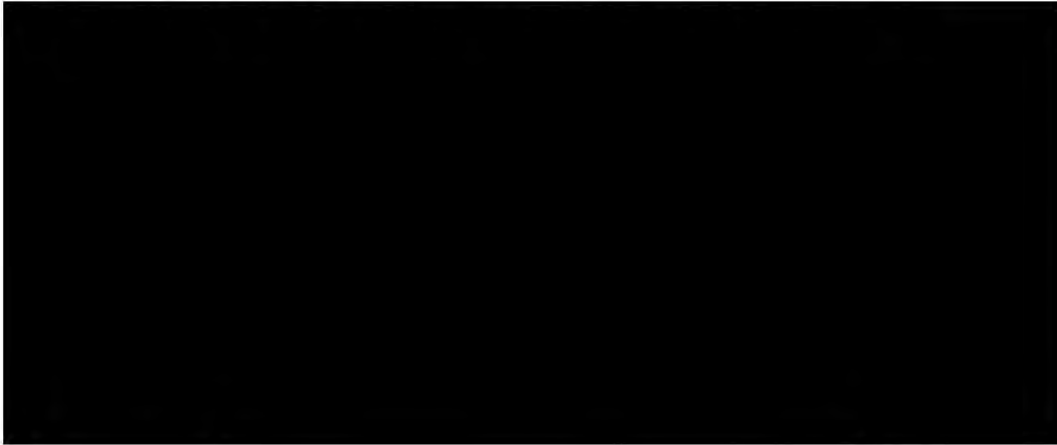

New Hampshire Design Violations Summary Report

Loading and Capacity

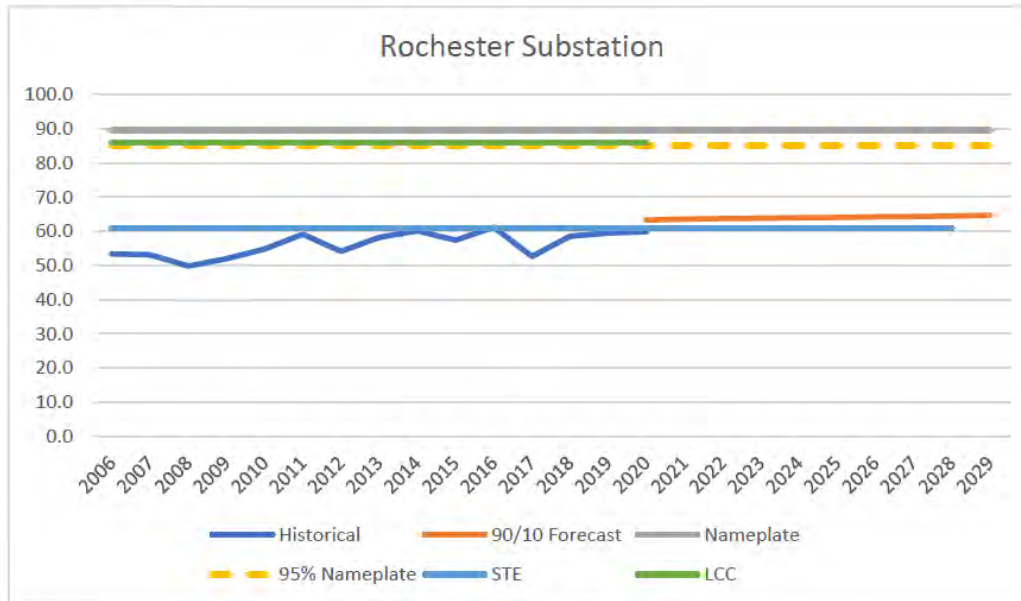

Distribution Company	Customers
Eversource Energy	20,160
Total Customers	20,160

	Mfg. Year	Condition Code ¹	Nameplate	LTE	STE ²	LCC
TB53	1968	1 – Green	44.8	56	61	
TB57	2002	1 – Green	44.8	56	67	
Substation			89.6		61	86.0

Note 1: Transformer condition code as of May 2020.

Note 2: Automatic bus restoral scheme, BT32 auto closes based on seasonal limits.

System Planning Violations & Needs

	N-0 Base Load	N-1 Transformer	N-1 STE	N-1 Bus	N-1 Bus Tie	N-1 Transmission
First Year	10+	10+	2020	10+	2020	n/a
Deficit	None	None	2.3 MW	None		n/a

Solution – Load Transfer

In-Service Date: June 1, 2021

- Transfer load to Tasker Farm to reduce loading on Rochester to address the N-1 STE design violation.

New Hampshire Design Violations Summary Report

BULK SUBSTATIONS – NORTHERN REGION

REDACTED

Ashland

20 Collins Street, Ashland, NH

Ashland Substation is a 115-34.5 kV open-air bulk substation with a single 44.8 MVA transformer and two distribution feeders. The distribution bus is operated as a single straight bus.

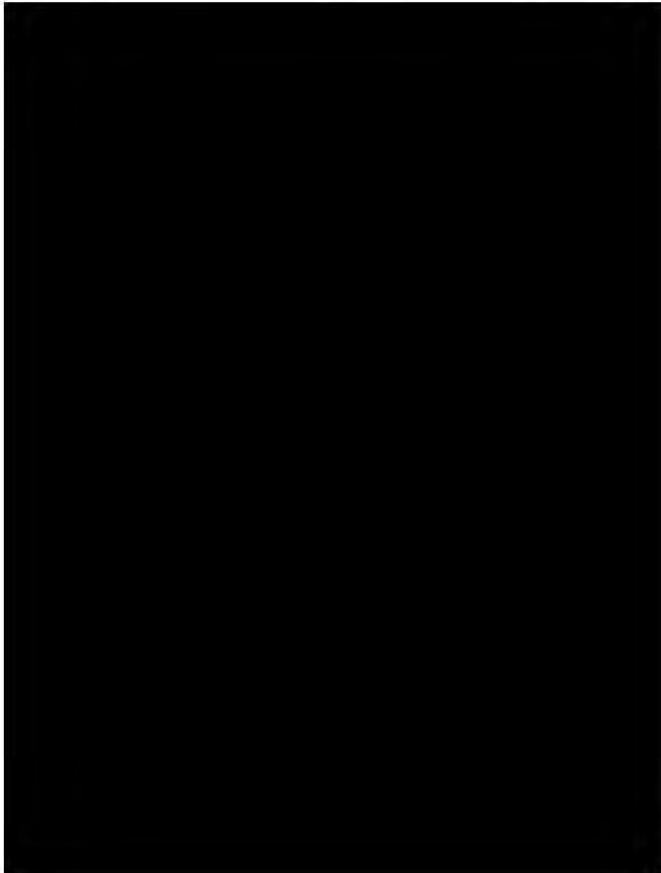

New Hampshire Design Violations Summary Report

Loading and Capacity

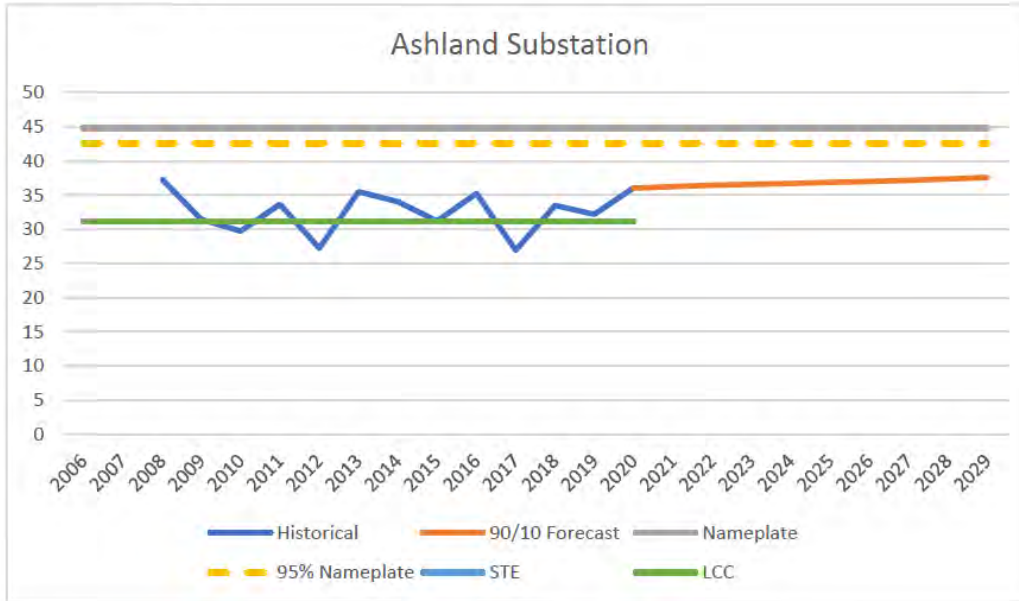

Distribution Company	Customers
Eversource Energy	141
New Hampshire Electric Cooperative	14,821
Town of Ashland Electric Department	1,583
Total Customers	16,523

	Mfg. Year	Condition Code ¹	Nameplate	LTE	STE	LCC
TB5	2005	1 – Green	44.8	53	64	
Substation			44.8			31.2

Note 1: Transformer condition code as of May 2020.

System Planning Violations & Needs

	N-0 Base Load	N-1 Transformer	N-1 STE	N-1 Bus	N-1 Bus Tie	N-1 Transmission
First Year	10+	2020	n/a	2020	n/a	n/a
Deficit	None	8.8 MW	n/a	8.8 MW	n/a	n/a

Solution – Transformer Addition

In-Service Date: June 1, 2024

- Add a second transformer at Ashland Substation.
- A third and fourth feeder to Meredith and Ashland Municipal should be analyzed with the addition of the transformer to increase feeder capacity to utilize substation capacity.

As a result of adding a second transformer, transmission work will be required to resolve the design violation of a Transmission N-1 producing greater than a Distribution N-1 at Ashland.

A solution of adding a second transformer at Ashland Substation addresses not only design violations at Ashland, but positively impacts neighboring stations by increasing their LCC capacity. This resolves N-1 violations at Beebe River and Pemigewasset Substations.

	Planning Study	Initial Funding	SDC Presentation	SDC Approval	EPAC Full Funding
Planned	Need to revise existing study. 1/15/2021	3/1/2021	10/1/2021	11/1/2021	11/1/2022
Actual					

REDACTED

New Hampshire Design Violations Summary Report

Beebe River

738 NH Route 175, Campton, NH

Beebe River Substation is a 115-34.5 kV open-air bulk substation with a single 44.8 MVA transformer and two distribution feeders. The distribution bus is operated as a single straight bus.

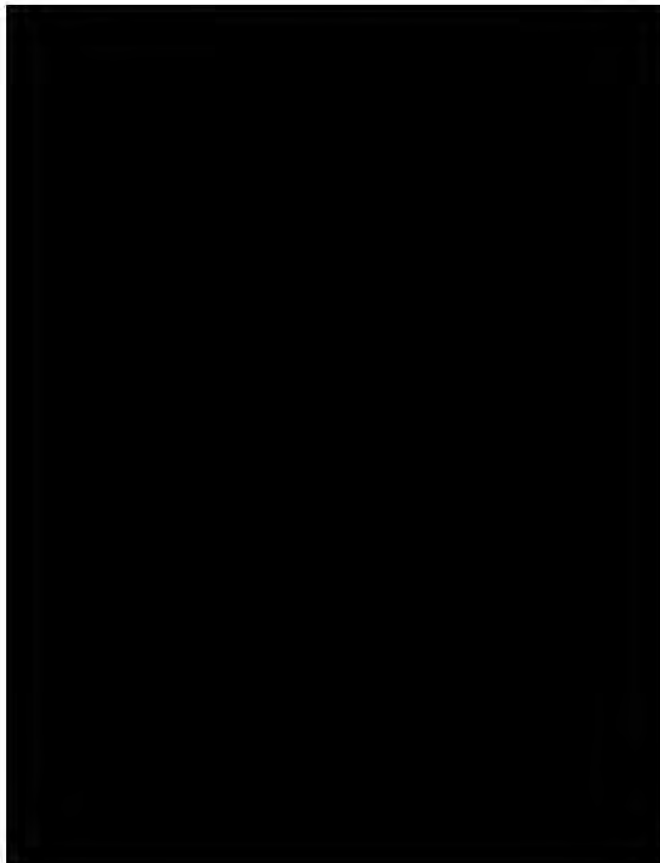

New Hampshire Design Violations Summary Report

Loading and Capacity

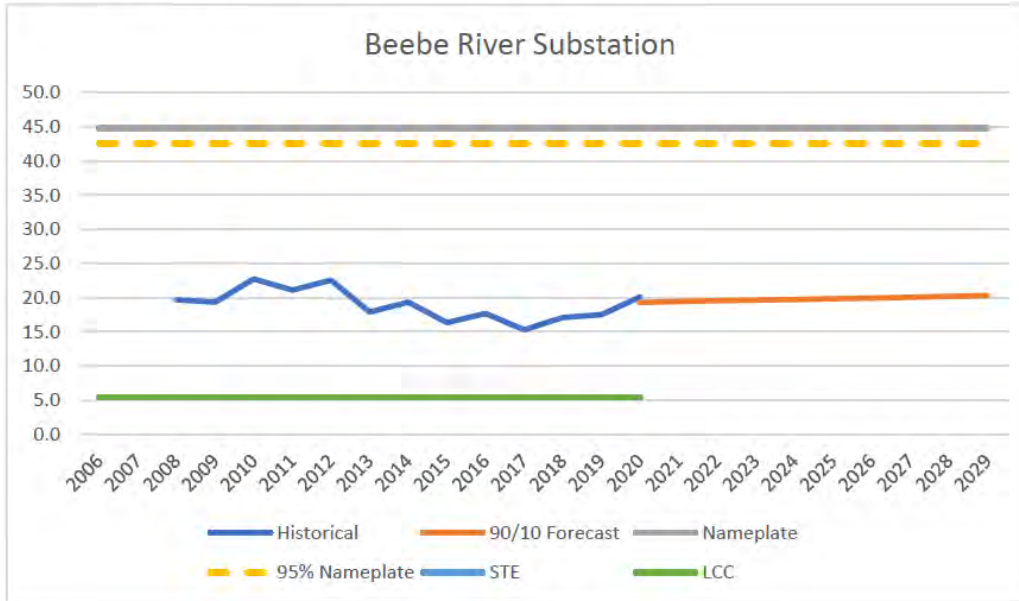

Distribution Company	Customers
Eversource Energy	1,513
New Hampshire Electric Cooperative	11,010
Total Customers	12,523

	Mfg. Year	Condition Code ¹	Nameplate	LTE	STE	LCC
TB62	1974	2 – Yellow	44.8	53	61	
Substation			44.8			5.4

Note 1: Transformer condition code as of May 2020.

System Planning Violations & Needs

	N-0 Base Load	N-1 Transformer	N-1 STE	N-1 Bus	N-1 Bus Tie	N-1 Transmission
First Year	10+	2020	n/a	2020	n/a	n/a
Deficit	None	14.9 MW	n/a	14.9 MW	n/a	n/a

Solution – Ashland Transformer Addition

Add a second transformer at Ashland Substation increasing LCC. See [Ashland Substation](#) for details.

REDACTED

New Hampshire Design Violations Summary Report

Berlin (Eastside)

300 Gobel Street, Berlin, NH

Berlin Substation is a 115-34.5 kV open-air bulk substation with a 15 MVA and a 20 MVA transformer and three distribution feeders. A grounding bank is installed on Bus 1 since transformer TB115 is a grounded wye-delta transformer. The distribution bus is operated as a single straight bus.

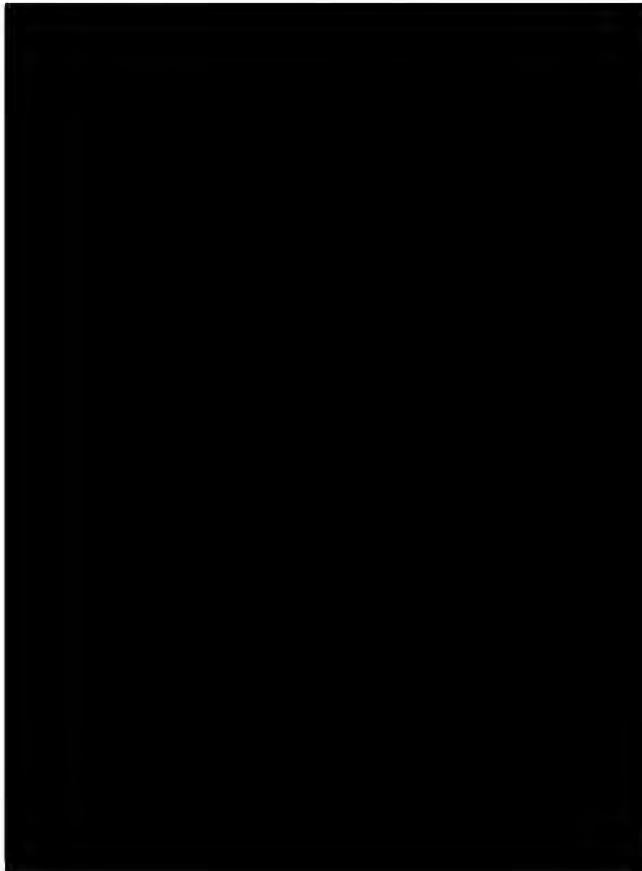

Loading and Capacity

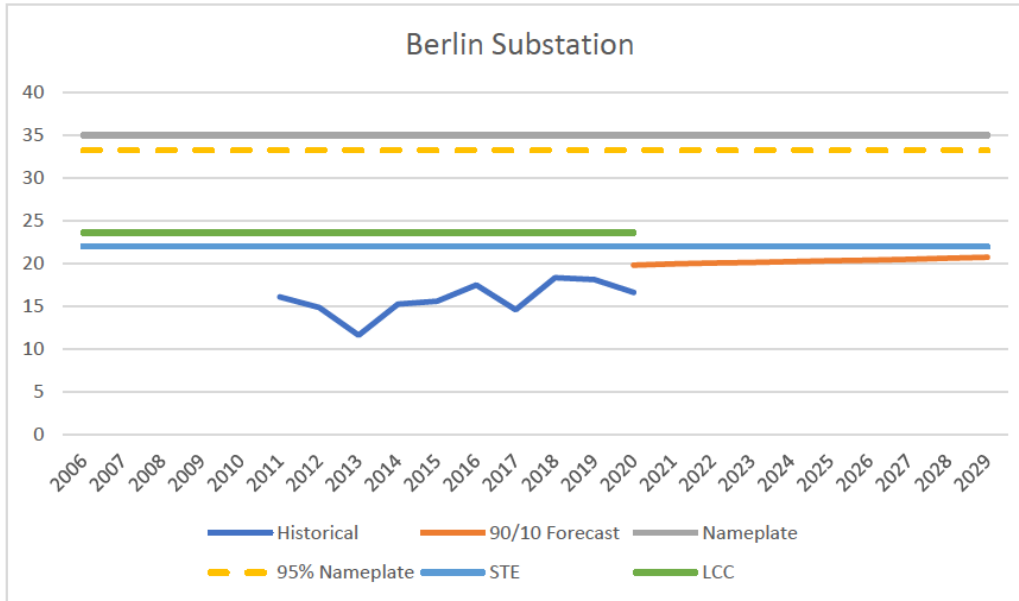

Distribution Company	Customers
Eversource Energy	9,937
Total Customers	9,937

	Mfg. Year	Condition Code ¹	Nameplate	LTE	STE	LCC
TB83	1854	2 – Yellow	20	28	30	
TB115	1947	2 – Yellow	15	20	22	
Substation			35		22	23.6

Note 1: Transformer condition code as of May 2020.

Thermal Rating Limitations

TB83 – Summer LTE is restricted to 28 MVA due to the requirement by System Operations to maintain a 2 MVA difference between LTE and STE. The transformer is calculated to be able to sustain a 29 MVA Summer LTE rating.

TB115 – Summer LTE is restricted to 20 MVA due to the requirement by System Operations to maintain a 2 MVA difference between LTE and STE. The transformer is calculated to be able to sustain a 21 MVA Summer LTE rating.

System Planning Violations & Needs

	N-0 Base Load	N-1 Transformer	N-1 STE	N-1 Bus	N-1 Bus Tie	N-1 Transmission
First Year	10+	10+	10+	2020	n/a	n/a
Deficit	None	None	None		n/a	n/a

Solution

In-Service Date: TBD

Solution to be determined. Voltage support along the 34.5 kV distribution lines may enable full restoration of Berlin for a Berlin N-1 bus fault contingency.

	Planning Study	Initial Funding	SDC Presentation	SDC Approval	EPAC Full Funding
Planned	Berlin 4/1/2021	TBD	TBD	TBD	TBD
Actual					

REDACTED

New Hampshire Design Violations Summary Report

Laconia

176 Lafayette Street, Laconia, NH

Laconia Substation is a 115-34.5 kV open-air bulk substation with two 44.8 MVA transformers and five distribution feeders. The distribution bus is operated as a single bus.

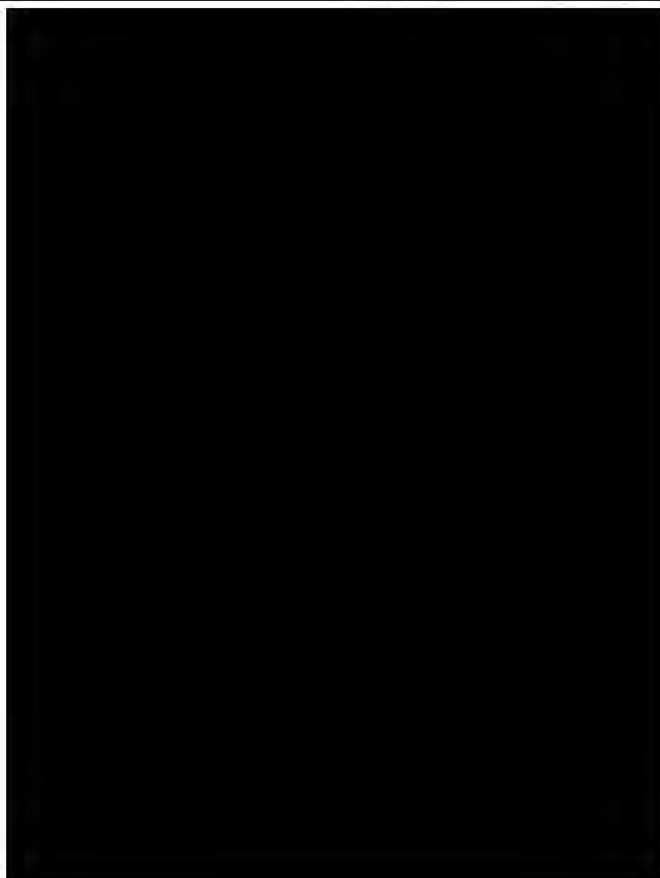

Loading and Capacity

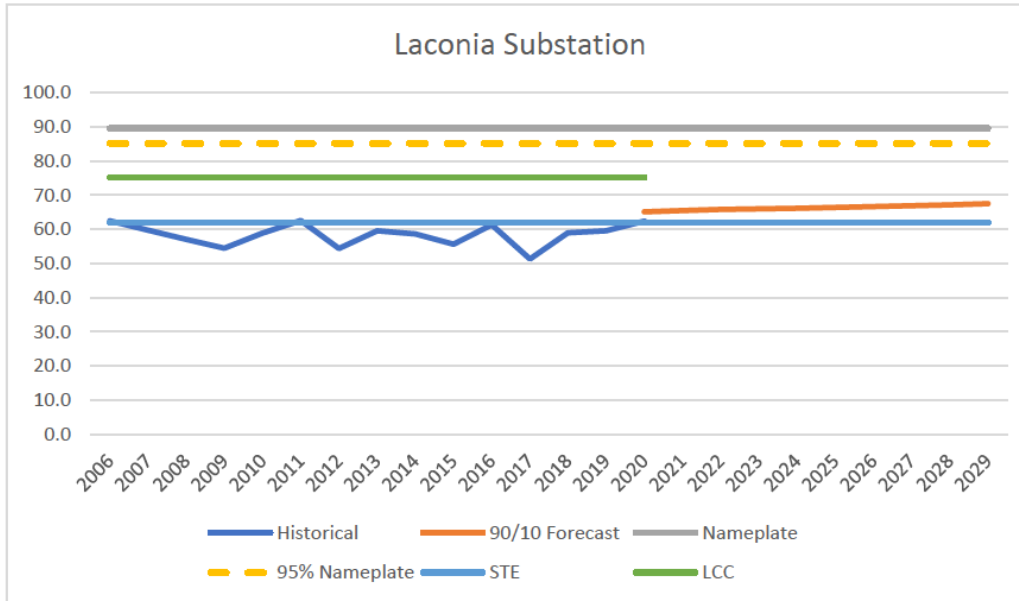

Distribution Company	Customers
Eversource Energy	23,299
New Hampshire Electric Cooperative	1,169
Total Customers	24,468

	Mfg. Year	Condition Code ¹	Nameplate	LTE	STE ²	LCC
TB24	1977	2 – Yellow	44.8	54	62	
TB125	2002	1 – Green	44.8	54	67	
Substation			89.6		62	75.2

Note 1: Transformer condition code as of May 2020.

Note 2: The transformer protection scheme that sheds feeders 310 and 3222 is disabled.

Thermal Rating Limitations

TB24 – Summer LTE is restricted to 48 MVA due to limitations with CT #8A and #8B. The transformer is calculated to be able to sustain a 54 MVA Summer LTE rating.

TB125 – Summer STE is restricted to 66 MVA due to limitations with CT #33. The transformer is calculated to be able to sustain a 67 MVA Summer STE rating.

Condition Assessment

Currently monitoring the ground water due to prior TB24 Oil spill. Can't fully remediate the oil until TB24 and its slab are removed.

System Planning Violations & Needs

	N-0 Base Load	N-1 Transformer	N-1 STE	N-1 Bus	N-1 Bus Tie	N-1 Transmission
First Year	10+	10+	2020	2020	n/a	n/a
Deficit	None	None	3.1 MW	41.7 MW	n/a	n/a

Solution – Load Transfer

In-Service Date: June 1, 2021

- Transfer load to Webster/Daniel Substation to reduce loading on Laconia to address the N-1 STE design violation.

Solution – Series Bus Tie Breakers Addition

In-Service Date: June 1, 2024

- Add series bus tie breakers to Laconia Substation.

	Planning Study	Initial Funding	SDC Presentation	SDC Approval	EPAC Full Funding
Planned	Laconia 7/1/2021	3/1/2021	4/1/2022	5/1/2022	5/1/2023
Actual					

REDACTED

New Hampshire Design Violations Summary Report

Lost Nation

1503 Lost Nation Road, Northumberland, NH

Lost Nation Substation is a 115-34.5 kV open-air bulk substation with a 28 and 44.8 MVA transformer and four distribution feeders. Of the four feeders, three serve customer load and one is a feeder to the Lost Nation combustion turbine. The distribution bus is operated as a single bus.

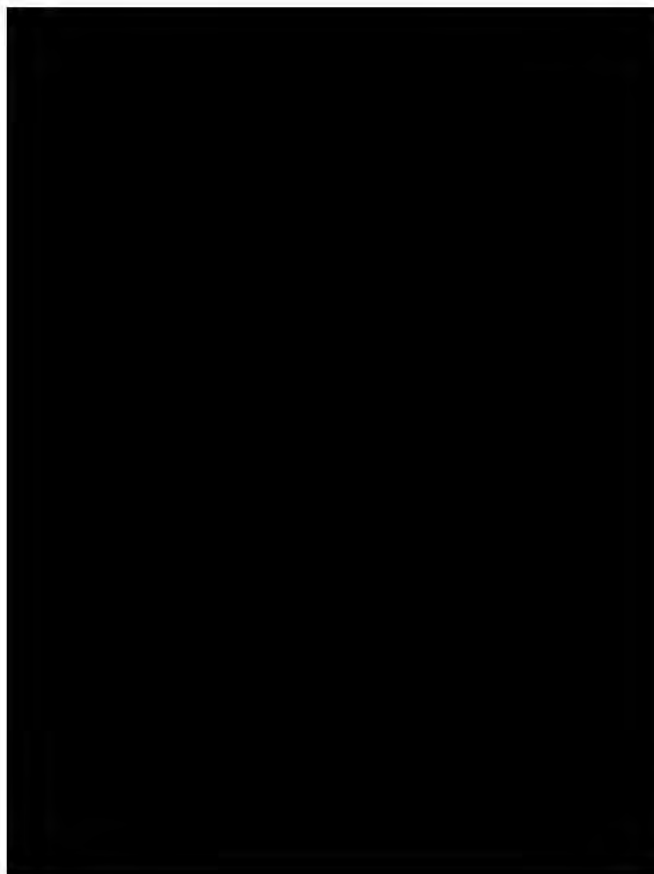
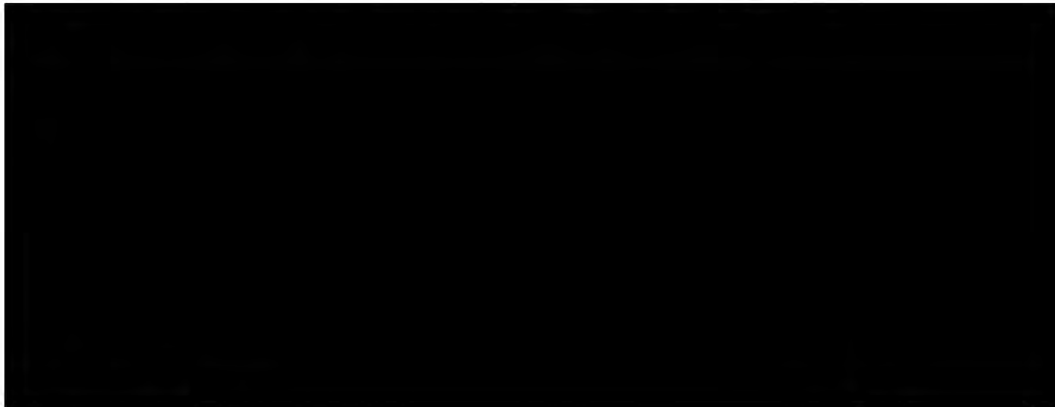

Loading and Capacity

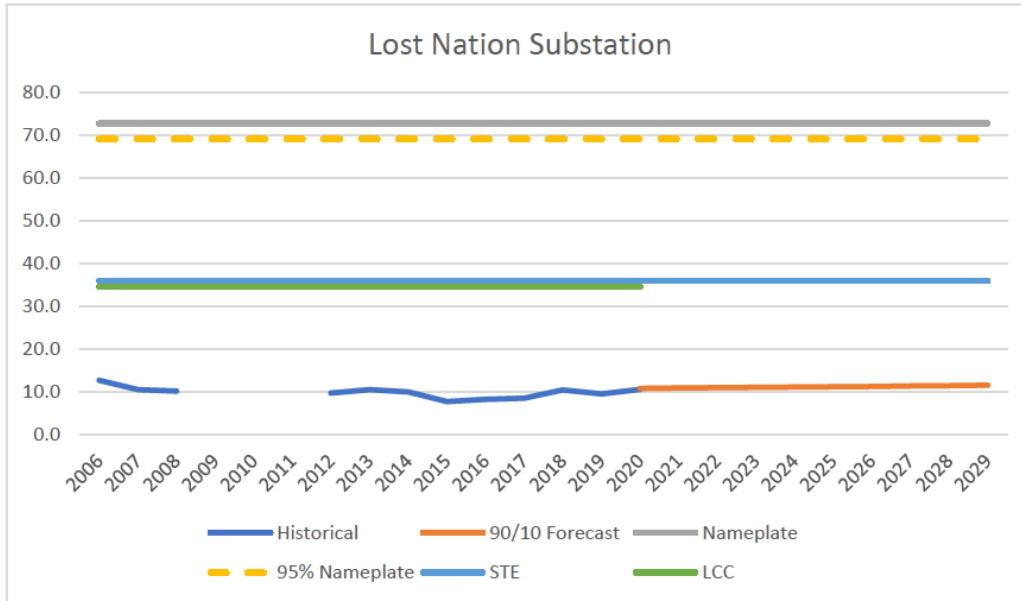

Distribution Company	Customers
Eversource Energy	6,515
New Hampshire Electric Cooperative	1,659
Total Customers	8,174

	Mfg. Year	Condition Code ¹	Nameplate	LTE	STE	LCC
TB033	1961	2 – Yellow	28.0	33	36	
TX129	2017	1 – Green	44.8	55	60	
Substation			72.8		36	34.6

Note 1: Transformer condition code as of May 2020.

Thermal Rating Limitations

TB033 – Summer STE is restricted to 36 MVA due to limitations with CT #39 and #1B. The transformer is calculated to be able to sustain a 39 MVA Summer STE rating.

TX129 – Summer STE is restricted to 60 MVA due to limitations with CT #39 and #52. The transformer is calculated to be able to sustain a 67 MVA Summer STE rating.

System Planning Violations & Needs

	N-0 Base Load	N-1 Transformer	N-1 STE	N-1 Bus	N-1 Bus Tie	N-1 Transmission
First Year	10+	10+	10+	2020	n/a	n/a
Deficit	None	None	None	0.6 MW	n/a	n/a

Solution – Distribution SCADA

In-Service Date: June 1, 2022

- Replace the manual J554 load-break switch with a SCADA-controlled device in order to restore load on the radial 384 feeder.

REDACTED

North Woodstock

145 Eastside Road, North Woodstock, NH

North Woodstock Substation is a 115-34.5 kV open-air bulk substation with a single 44.8 MVA transformer and two distribution feeders. The distribution bus is operated as a single straight bus.

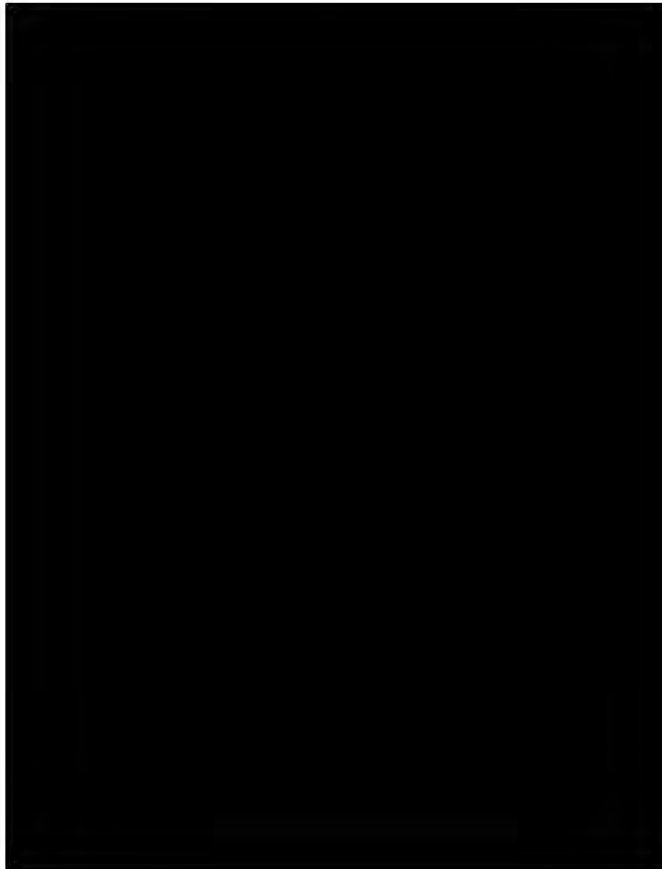
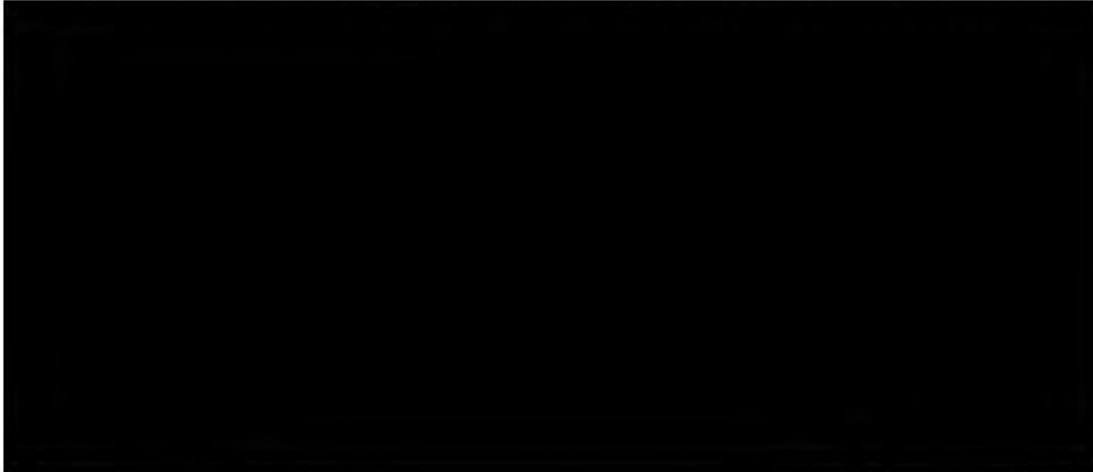

New Hampshire Design Violations Summary Report

Loading and Capacity

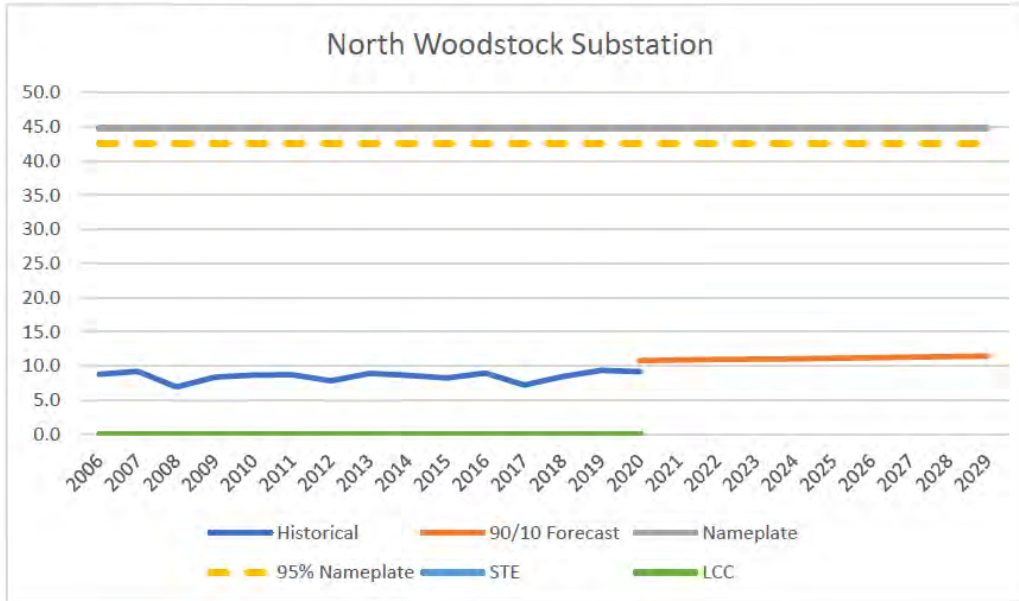

Distribution Company	Customers
New Hampshire Electric Cooperative	4,739
Total Customers	4,739

	Mfg. Year	Condition Code ¹	Nameplate	LTE	STE	LCC
TB67	1986	1 – Green	44.8	54	64	
Substation			44.8			0.0

Note 1: Transformer condition code as of May 2020.

System Planning Violations & Needs

	N-0 Base Load	N-1 Transformer	N-1 STE	N-1 Bus	N-1 Bus Tie	N-1 Transmission
First Year	10+	2020	n/a	2020	n/a	n/a
Deficit	None	10.8 MW	n/a	10.8 MW	n/a	n/a

Solution

New Hampshire Electric Cooperative is adding SCADA control to their distribution system. Installations are commencing in their 12.47 kV lines with eventual installations on their 34.5 kV sub-transmission system. No timeline has been set by NHEC on when D-SCADA will be added to the 34.5 kV system.

REDACTED

New Hampshire Design Violations Summary Report

Oak Hill

40 Farmwood Road, Concord, NH

Oak Hill Substation is a 115-34.5 kV open-air bulk substation with a 44.8 MVA and 45 MVA transformer and four distribution feeders, two of which operate in parallel supplying Unitil Energy System's Penacook Substation. The distribution bus is operated with a closed bus tie breaker.

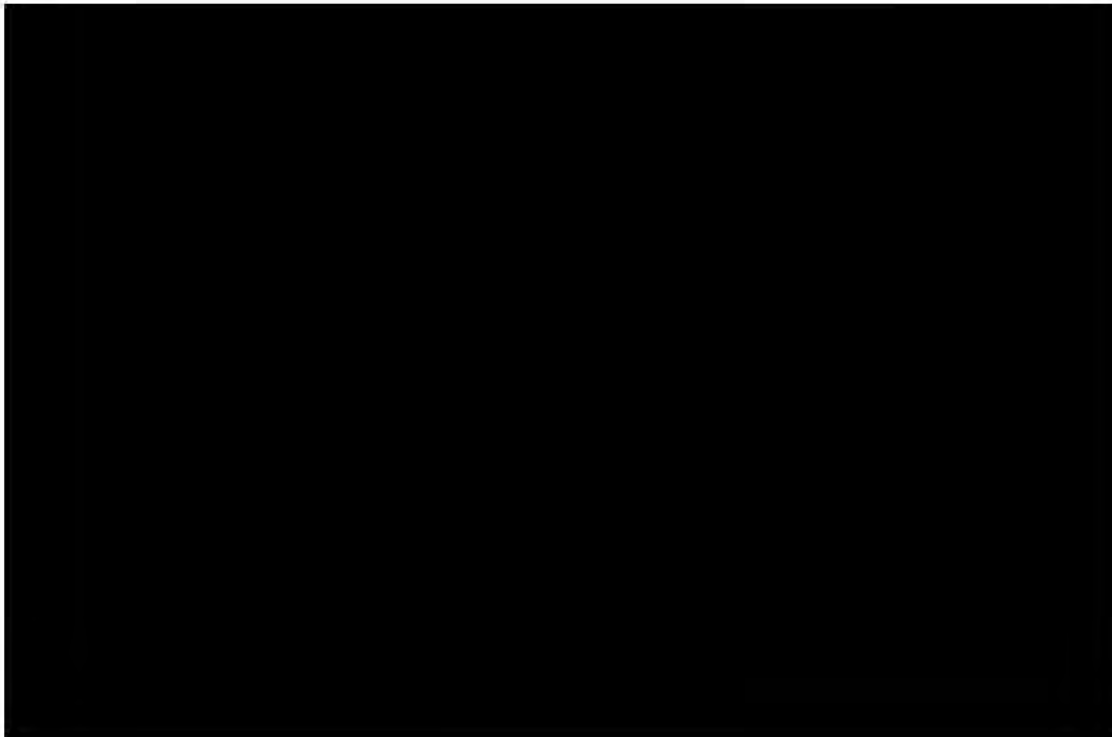
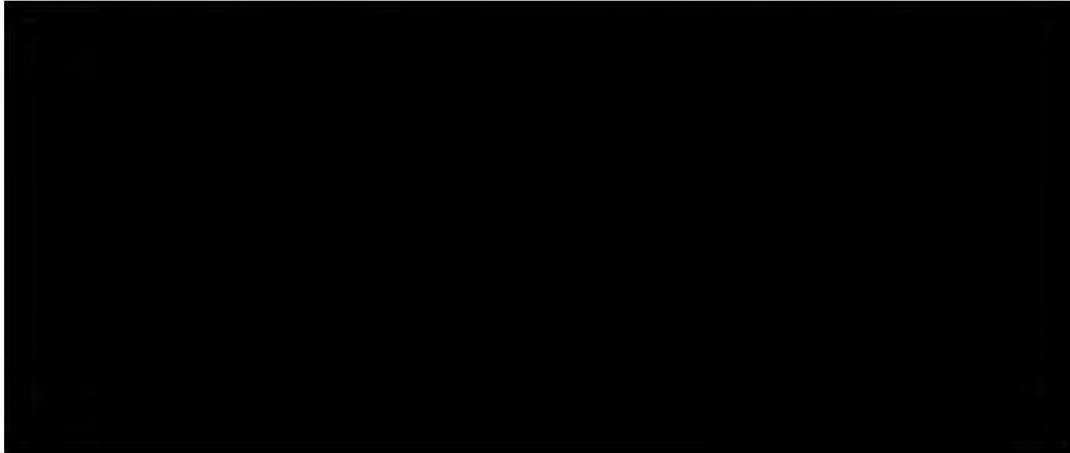

New Hampshire Design Violations Summary Report

Loading and Capacity

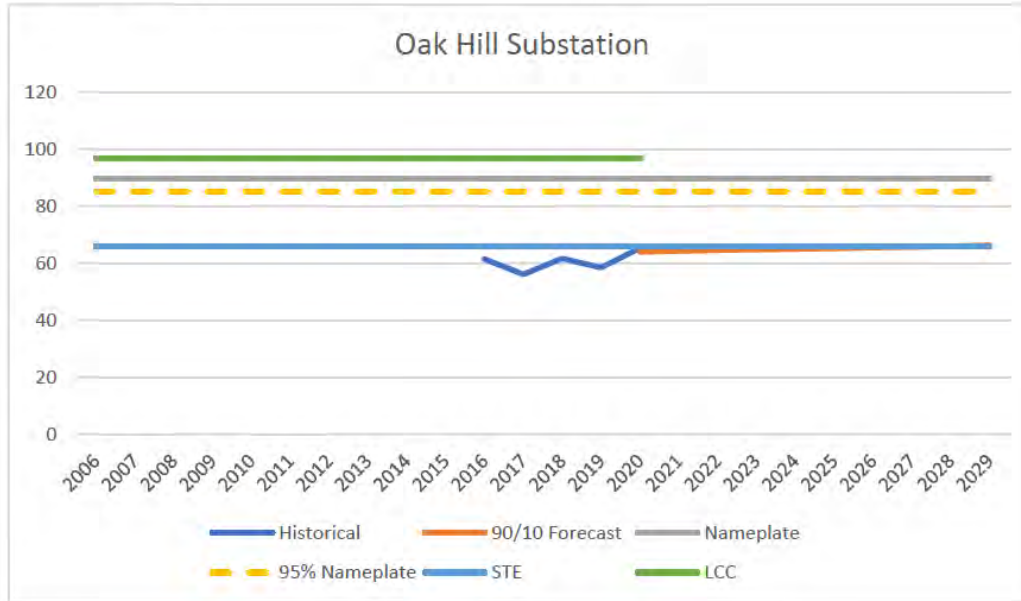

Distribution Company	Customers
Eversource Energy	12,911
Unitil Energy Systems	10,670
Total Customers	23,581

	Mfg. Year	Condition Code ¹	Nameplate	LTE	STE	LCC
TB15	2003	1 – Green	44.8	55	67	
TB84	1991	1 – Green	45.0	51	66	
Substation			89.8		66	97.0

Note 1: Transformer condition code as of May 2020.

System Planning Violations & Needs

	N-0 Base Load	N-1 Transformer	N-1 STE	N-1 Bus	N-1 Bus Tie	N-1 Transmission
First Year	10+	10+	2028	2020	2020	n/a
Deficit	None	None	0.1 MW	10.9 MW		n/a

Solution

In-Service Date: June 1, 2020

- Transfer load to Garvins Substation to reduce loading on Oak Hill to address the N-1 STE design violation.
 - Unitil performs this switching already and chooses to do it seasonally as needed. Presently, Oak Hill station load exceeds a single transformer LTE, but not STE. Unitil chooses to preconfigure their Capital Division per anticipated N-1 switching for loss of a transformer. Eversource performs its switching reactively.

Add transformer and feeder capacity at Madbury Substation increasing LCC for restoration during a bus fault or bus tie breaker failure. See [Madbury Substation](#) for details.

	Planning Study	Initial Funding	SDC Presentation	SDC Approval	EPAC Full Funding
Planned	Eversource-UES Joint Planning Study	n/a	n/a	n/a	n/a
Actual	9/10/2020				

REDACTED

Pemigewasset

731 Old Bristol Road, New Hampton, NH

Pemigewasset Substation (aka "Pemi") is a 115-34.5 kV open-air bulk substation with a single 62.5 MVA transformer and three distribution feeders. Of the three feeders, two serve customer load and one is a feeder to Ayers Island Hydro. The distribution bus is operated as a single straight bus.

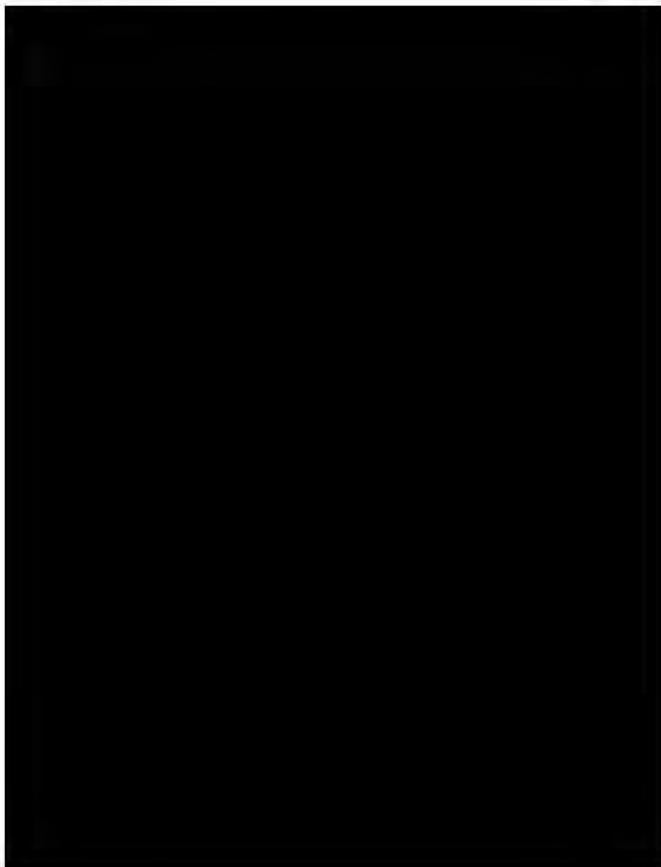
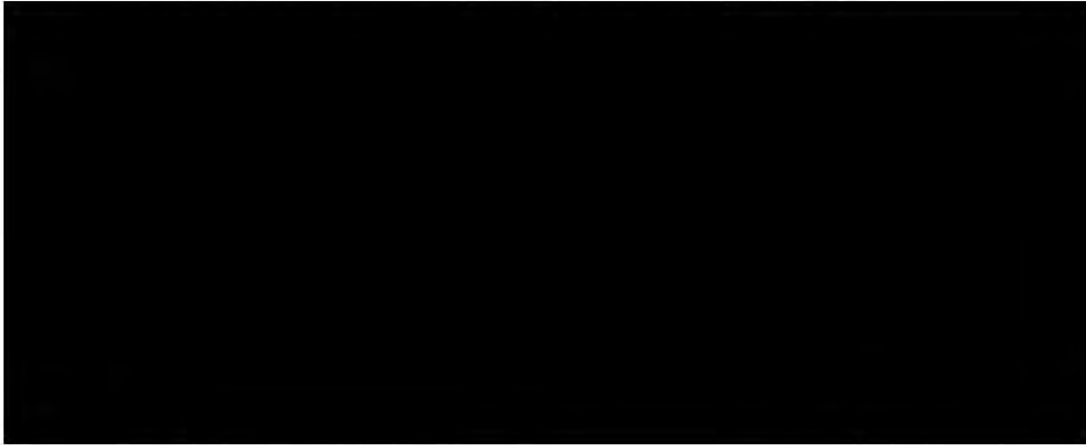

New Hampshire Design Violations Summary Report

Loading and Capacity

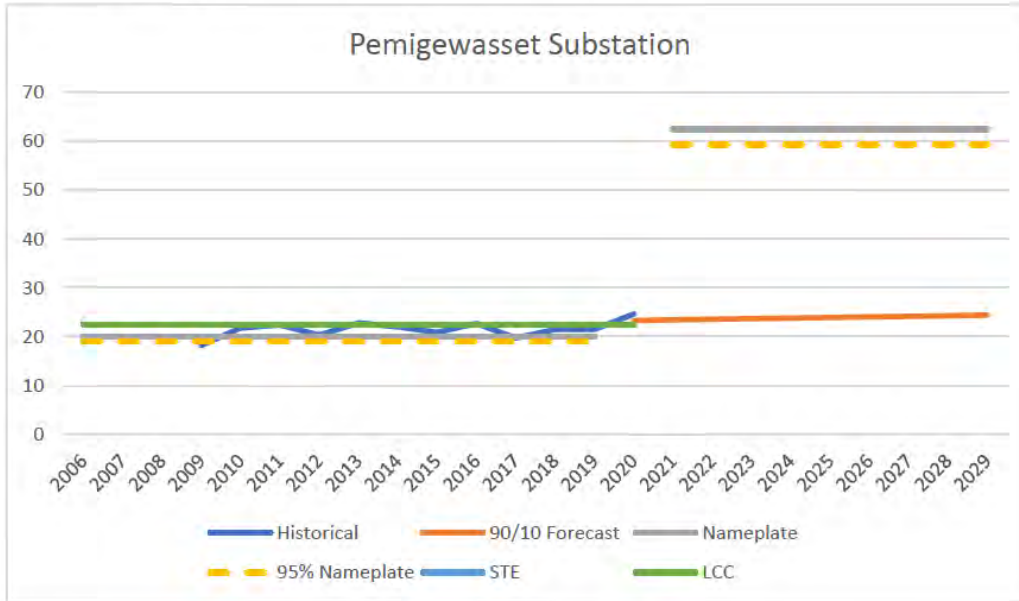

Distribution Company	Customers
Eversource Energy	7,740
New Hampshire Electric Cooperative	3,275
New Hampton Village Precinct Electric Department	206
Total Customers	11,221

	Mfg. Year	Condition Code ¹	Nameplate	LTE	STE	LCC
TX88 ²	2018	n/a	62.5	80	93	
Substation			62.5			22.5

Note 1: Transformer condition code as of May 2020.

Note 2: 20 MVA TB88 replaced with a new 62.5 MVA TX88. In service 2020 Q4.

System Planning Violations & Needs

	N-0 Base Load	N-1 Transformer	N-1 STE	N-1 Bus	N-1 Bus Tie	N-1 Transmission
First Year	10+	2020	n/a	2020	n/a	n/a
Deficit	None	0.8 MW	n/a	12.6 MW	n/a	n/a

Solution – Ashland Transformer Addition

Add a second transformer at Ashland Substation increasing LCC. See [Ashland Substation](#) for details.

REDACTED

New Hampshire Design Violations Summary Report

Saco Valley

80 East Conway Road, Conway, NH

Saco Valley Substation is a 115-34.5 kV open-air bulk substation with a single 44.8 MVA transformer and three distribution feeders. The distribution bus is operated as a single straight bus.

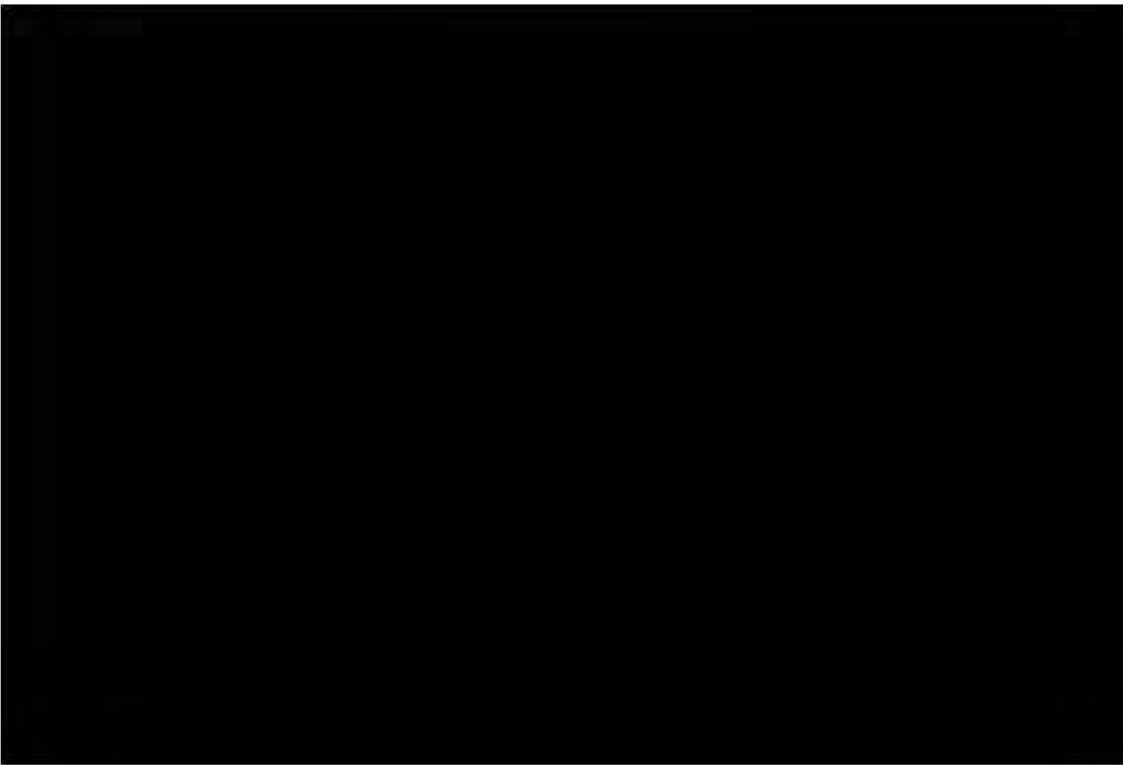

New Hampshire Design Violations Summary Report

Loading and Capacity

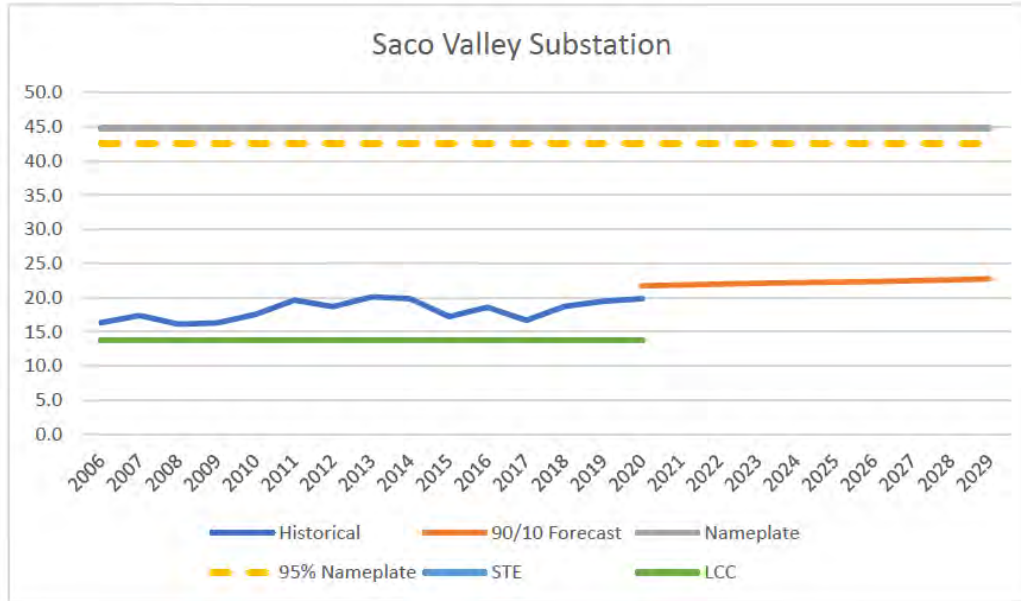

Distribution Company	Customers
Eversource Energy	6,647
New Hampshire Electric Cooperative	492
Total Customers	7,139

	Mfg. Year	Condition Code ¹	Nameplate	LTE	STE	LCC
TB60	1976	1 – Green	44.8	53	62	
Substation			44.8			13.8

Note 1: Transformer condition code as of May 2020.

System Planning Violations & Needs

	N-0 Base Load	N-1 Transformer	N-1 STE	N-1 Bus	N-1 Bus Tie	N-1 Transmission
First Year	10+	2020	n/a	2020	n/a	n/a
Deficit	None	7.9 MW	n/a	8.7 MW	n/a	n/a

Solution – Distribution SCADA

In-Service Date: June 1, 2022

- Replace the manual J4795 load-break switch with a SCADA-controlled device in order to restore load on the radial 395 feeder.

Solution – White Lake Transformer Replacement

Replace transformers at White Lake Substation increasing LCC. See [White Lake Substation](#) for details.

REDACTED

New Hampshire Design Violations Summary Report

Webster and Daniel

Webster: 130 Webster Lake Road, Franklin, NH

Daniel: 100 Webster Lake Road, Franklin, NH

Webster Substation is a 115 kV substation with two 44.8 MVA transformers. It supplies Daniel Substation, a 34.5 kV switching station with three distribution feeders. The distribution bus is operated with an open bus tie breaker.

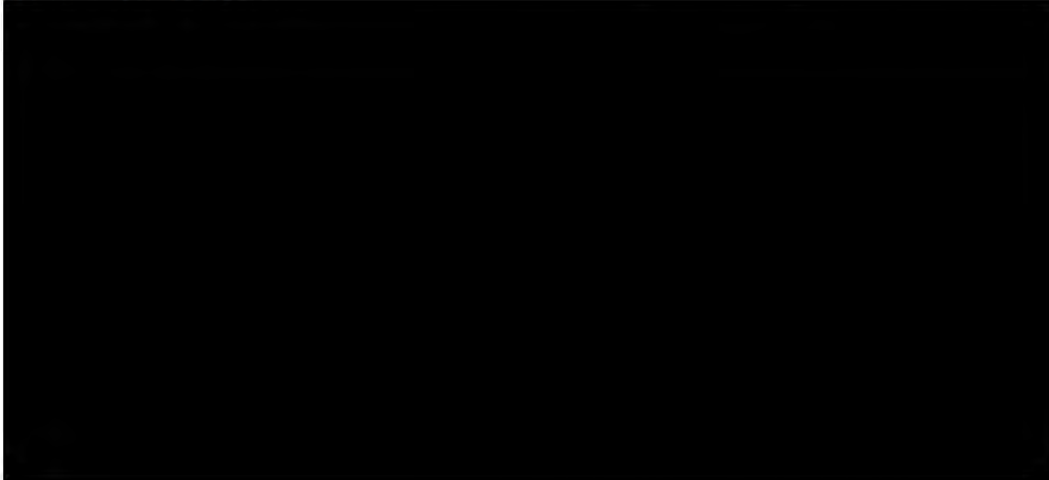

REDACTED

New Hampshire Design Violations Summary Report



Loading and Capacity

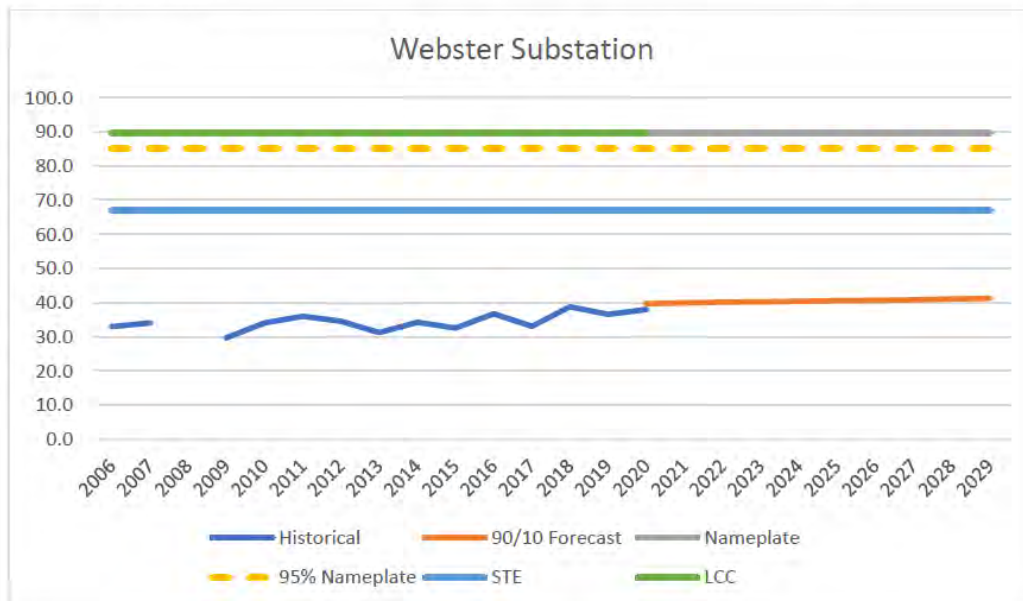

Distribution Company	Customers
Eversource Energy	8,319
New Hampshire Electric Cooperative	3,957
Total Customers	12,276

	Mfg. Year	Condition Code ¹	Nameplate	LTE	STE ²	LCC
TB43	2016	1 – Green	44.8	57	67	
TB59	2016	1 – Green	44.8	56	67	
Substation			89.6		67	89.7

Note 1: Transformer condition code as of May 2020.

Note 2: Automatic bus restoral scheme, BT50 auto closes based on seasonal limits.

System Planning Violations & Needs

	N-0 Base Load	N-1 Transformer	N-1 STE	N-1 Bus	N-1 Bus Tie	N-1 Transmission
First Year	10+	10+	10+	2020	2020	2020
Deficit	None	None	None	6.0 MW		

Transmission N-1 design violation is due to the straight bus and terminal locations of the distribution transformers and two lines to Laconia. Failure of bus tie breaker BT40 will isolate approximately 100 MW of customer load (those supplied by Webster and Laconia).

Solution – Distribution SCADA

In-Service Date: June 1, 2022

- Replace the manual 3216J2 load-break switch with a SCADA-controlled device in order to restore load on the radial 3193 feeder.

Solution – Webster Transmission N-1

In-Service Date: June 1, 2025

- Webster transmission N-1 solution. A study will need to be completed to find the optimal solution to the loss of Laconia and Webster with the BT40 bus tie failure.

	Planning Study	Initial Funding	SDC Presentation	SDC Approval	EPAC Full Funding
Planned	Webster 115 kV 2/28/2022	3/1/2021	4/1/2022	5/1/2022	5/1/2023
Actual					

REDACTED

New Hampshire Design Violations Summary Report

White Lake

289 Maple Drive, Tamworth, NH

White Lake Substation is a 115-34.5 kV open-air bulk substation with two 28 MVA transformers and four distribution feeders. The distribution bus is operated as a single straight bus.

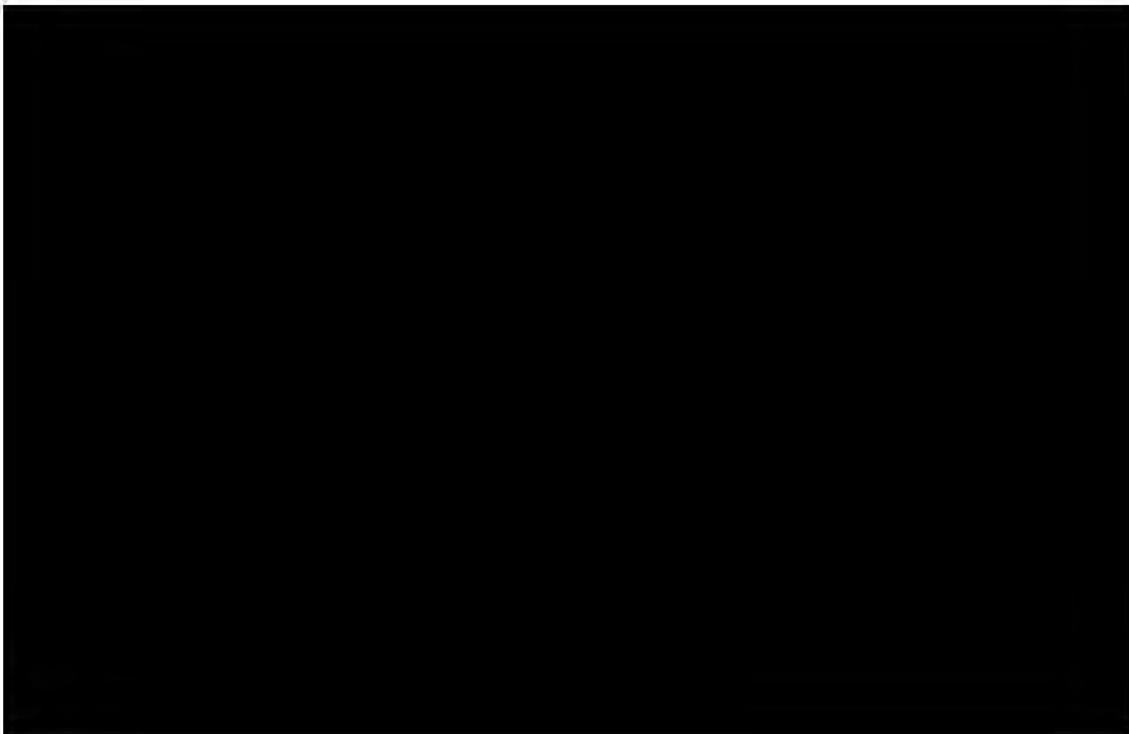
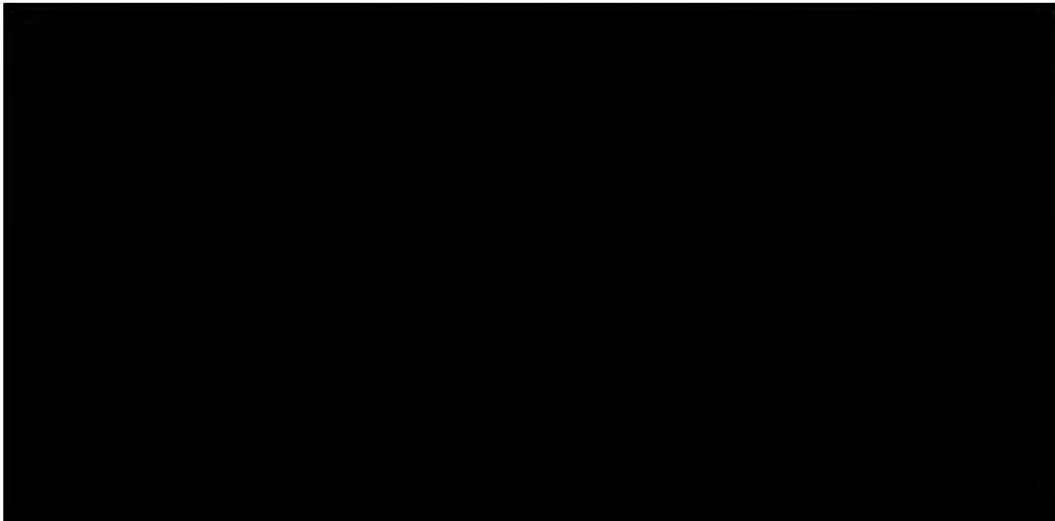

New Hampshire Design Violations Summary Report

Loading and Capacity

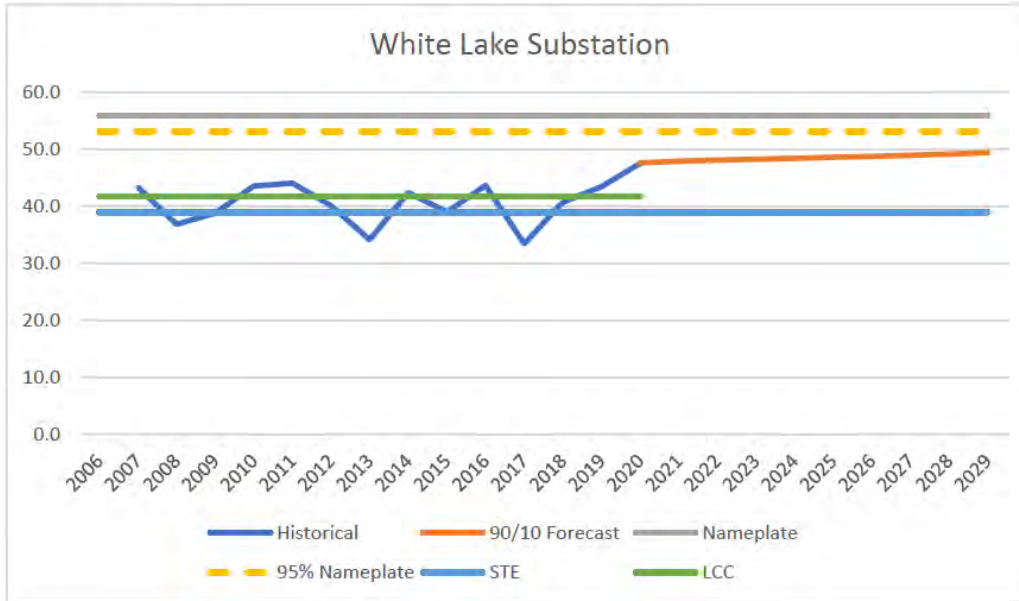

Distribution Company	Customers
Eversource Energy	11,053
New Hampshire Electric Cooperative	6,378
Town of Wolfeboro Electric Department	5,600
Total Customers	23,031

	Mfg. Year	Condition Code ¹	Nameplate	LTE	STE	LCC
TB76	1964	3 – Orange	28.0	34	39	
TB82	1963	2 – Yellow	28.0	33	39	
Substation			56.0		39	41.8

Note 1: Transformer condition code as of May 2020.

System Planning Violations & Needs

	N-0 Base Load ²	N-1 Transformer	N-1 STE	N-1 Bus	N-1 Bus Tie	N-1 Transmission
First Year	2021	2020	2020	2020	n/a	n/a
Deficit	0.1 MW	5.9 MW	8.7 MW	42.8 MW	n/a	n/a

Note 2: Load sharing is not equal between the two transformers, causing one transformer to exceed 95% nameplate despite substation load not exceeding 95% of total nameplate.

Solution – Transformer Replacement (D: A18N03, T: T1419A)

In-Service Date: June 1, 2023

- Replace both 28 MVA transformers at White Lake Substation with 62.5 MVA transformers to address base load, LCC, and N-1 STE capacity.
- Add series bus tie breakers to address to address N-1 bus fault violation.

As a result of increasing capacity, the LCC of Saco Valley is increased addressing the design violation at that location.

Due to asset condition, divestiture/access issues, and having oil circuit breakers, Substation Design Engineering has taken the lead on rebuilding White Lake Substation on adjacent property and will be incorporating the needs of System Planning to address all design violations.

	Planning Study	Initial Funding	SDC Presentation	SDC Approval	EPAC Full Funding
Planned	N/A	N/A	4/16/2021	4/16/2021	4/16/2022
Actual	N/A	6/10/2020			

REDACTED

New Hampshire Design Violations Summary Report

Whitefield

85 Lancaster Road, Whitefield, NH

Whitefield Substation is a 115-34.5 kV open-air bulk substation with a 44.8 MVA transformer and three distribution feeders. The distribution bus is operated as a single bus. Supplied from the 34.5 kV bus is the non-bulk Whitefield transformer serving local 12.47 kV distribution load.

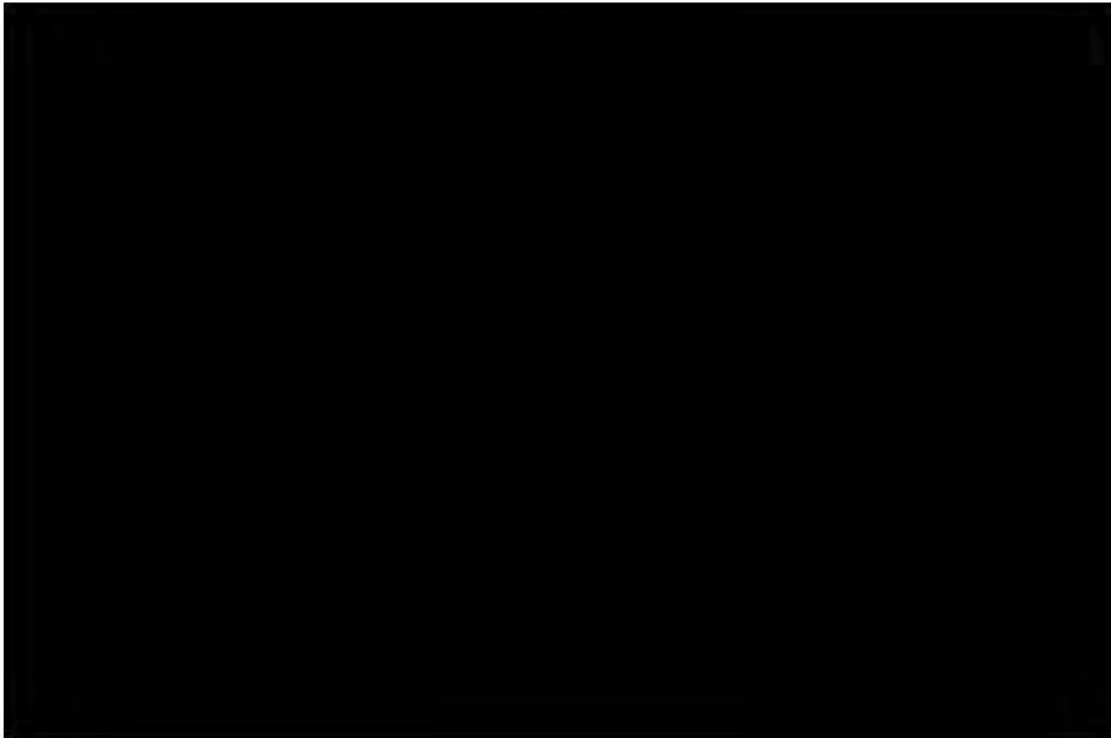
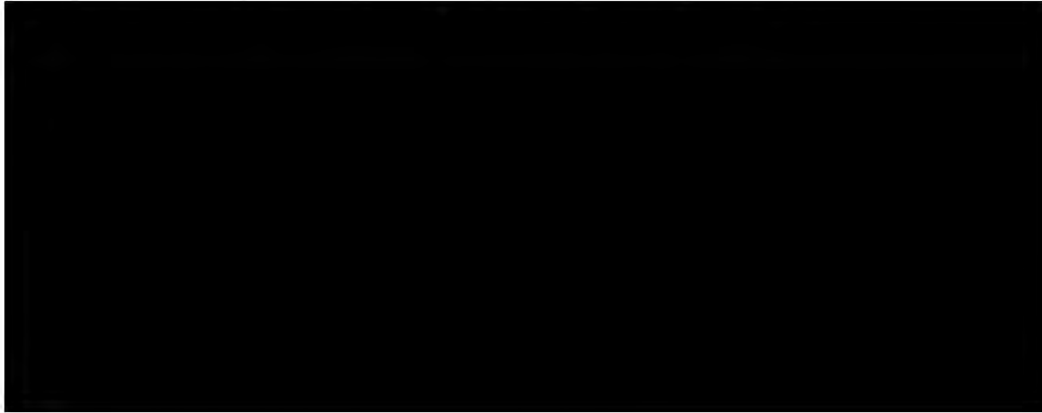

Loading and Capacity

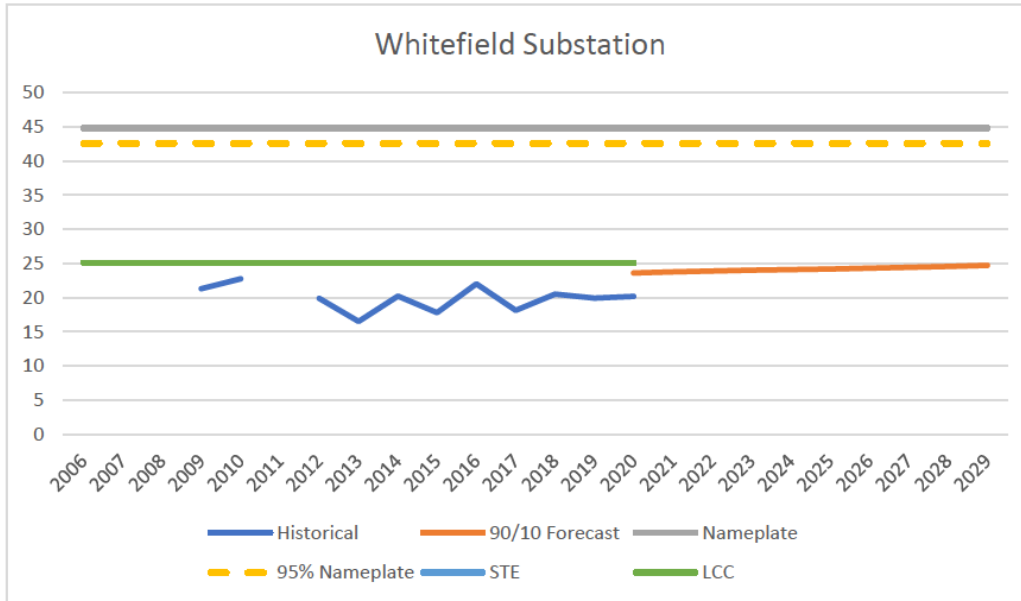

Distribution Company	Customers
Eversource Energy	11,034
New Hampshire Electric Cooperative	776
Total Customers	11,810

	Mfg. Year	Condition Code ¹	Nameplate	LTE	STE	LCC
TB89	1966	2 – Yellow	44.8	49	53	
Substation			44.8			25.1

Note 1: Transformer condition code as of May 2020.

Thermal Rating Limitations

TB89 – Summer ratings are restricted to 43/49/53 MVA (N/LTE/STE) due to limitations with switches 8901, 8903 and J1891. The transformer is calculated to be able to sustain ratings of 44/57/63 MVA.

System Planning Violations & Needs

	N-0 Base Load	N-1 Transformer	N-1 STE	N-1 Bus	N-1 Bus Tie	N-1 Transmission
First Year	10+	10+	10+	2020	n/a	n/a
Deficit	None	None	None	16.5 MW	n/a	n/a

After the addition of a 34.5 kV pole-top SCADA switch, the outcome of the N-1 bus fault event will be equivalent to that of an N-1 non-bulk transformer event. System Planning recognizes this issue with the planning criteria versus the unique physical arrangement of Whitefield Substation with a non-bulk substation fed directly from the 34.5 kV distribution bus. If the N-1 bus fault continues to be equal to the N-1 non-bulk transformer contingency, no further action shall be taken. Future System Planning studies will continue to monitor this violation.

Solution – Distribution SCADA

In-Service Date: June 1, 2022

- Replace the manual J5148 load-break switch with a SCADA-controlled device in order to restore load on the radial 348 feeder.

New Hampshire Design Violations Summary Report

BULK SUBSTATIONS – SOUTHERN REGION

REDACTED

New Hampshire Design Violations Summary Report

Amherst

2 Hertzka Drive, Amherst, NH

Amherst Substation is a 345-34.5 kV open-air bulk substation with two 140 MVA transformers and five distribution feeders. The distribution bus is operated with an open bus tie breaker.



New Hampshire Design Violations Summary Report

Loading and Capacity

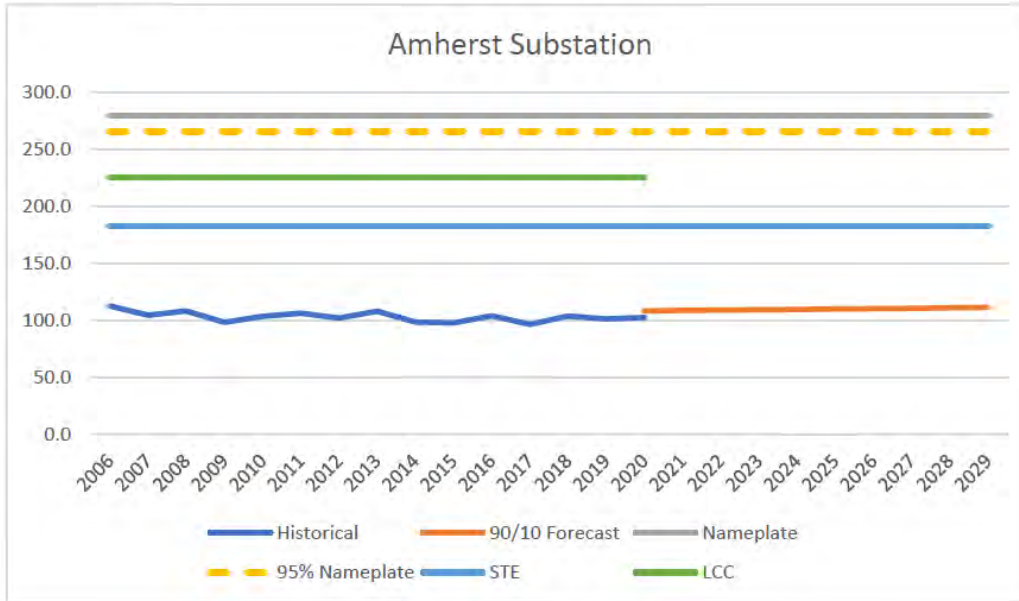

Distribution Company	Customers
Eversource Energy	54,978
Total Customers	54,978

	Mfg. Year	Condition Code ¹	Nameplate	LTE	STE	LCC
TB68	1987	1 – Green	140.0	165	183	
TB85	2003	1 – Green	140.0	205	210	
Substation			280.0		183	225.5

Note 1: Transformer condition code as of May 2020.

Thermal Rating Limitations

TB85 – Summer STE is restricted to 201 MVA due to limitations with CT #69. The transformer is calculated to be able to sustain a 210 MVA Summer STE rating.

System Planning Violations & Needs

	N-0 Base Load	N-1 Transformer	N-1 STE	N-1 Bus	N-1 Bus Tie	N-1 Transmission
First Year	10+	10+	10+	2020	2020	n/a
Deficit	None	None	None	48.5 MW		n/a

Solution

Amherst Bus 1 – Replace and add a second transformer at South Milford Substation increasing LCC of Amherst. See [South Milford Substation](#) for details.

Amherst Bus 2 – Replace both transformers at Bridge Street Substation increasing LCC of Amherst. See [Bridge Street Substation](#) for details.

REDACTED

Bridge Street

1 Jackson Square, Nashua, NH

Bridge Street Substation is a 115-34.5 kV switchgear bulk substation with two 44.8 MVA transformers and five distribution feeders. The distribution bus is operated as a single bus with a dummy bus tie breaker.

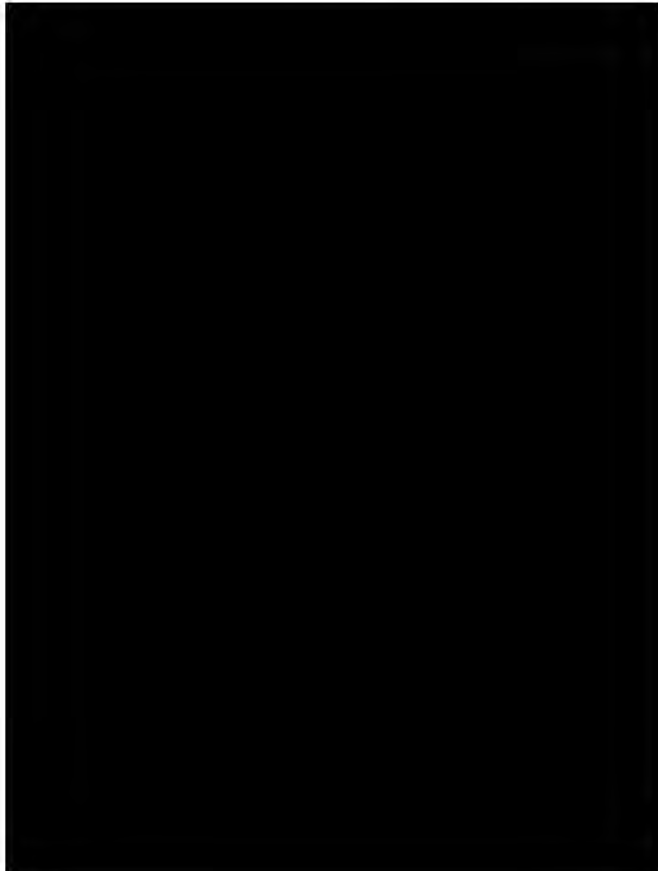
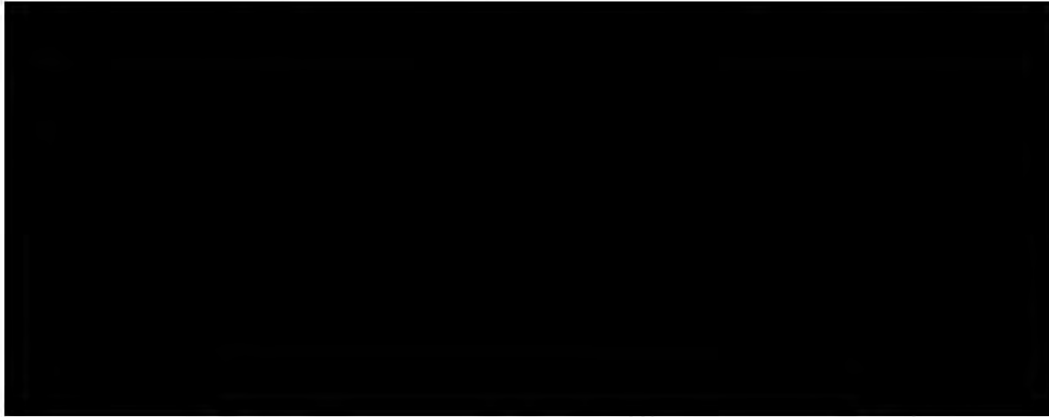

New Hampshire Design Violations Summary Report

Loading and Capacity

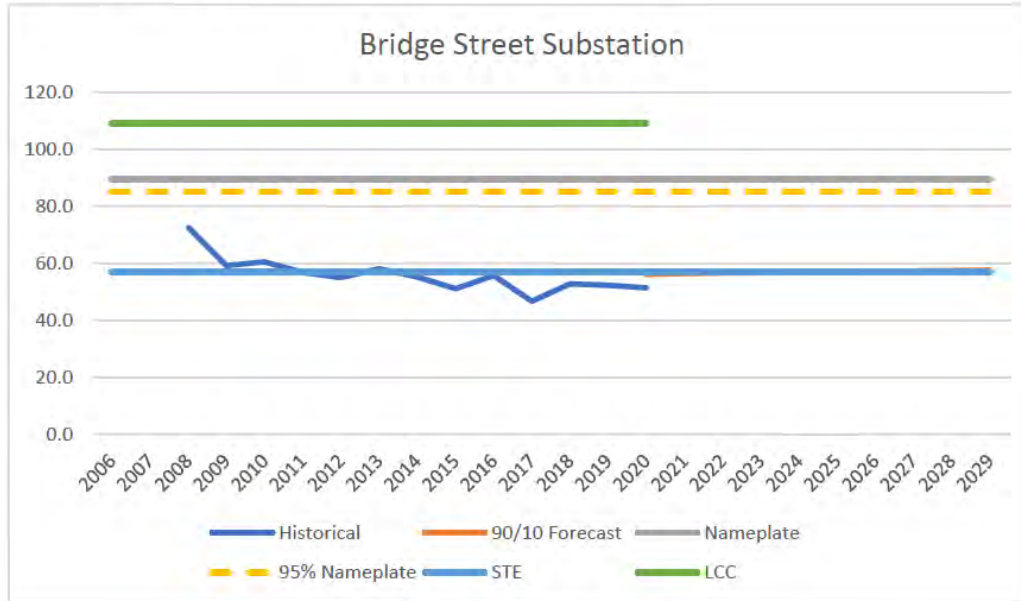

Distribution Company	Customers
Eversource Energy	13,688
Total Customers	13,688

	Mfg. Year	Condition Code ¹	Nameplate	LTE	STE	LCC
TB45	1973	2 – Yellow	44.8	57	57	
TB52	1973	2 – Yellow	44.8	57	57	
Substation			89.6		57	109.2

Note 1: Transformer condition code as of May 2020.

Condition Assessment

- 35 kV switchgear is obsolete. No current replacement program.
- Switchgear roof is leaking.
- Can't add a series breaker to the existing switchgear.

REDACTED

New Hampshire Design Violations Summary Report

System Planning Violations & Needs

	N-0 Base Load	N-1 Transformer	N-1 STE	N-1 Bus	N-1 Bus Tie	N-1 Transmission
First Year	10+	10+	2026	2020	n/a	2020
Deficit	None	None	0.2 MW		n/a	

Transmission N-1 Design Violation

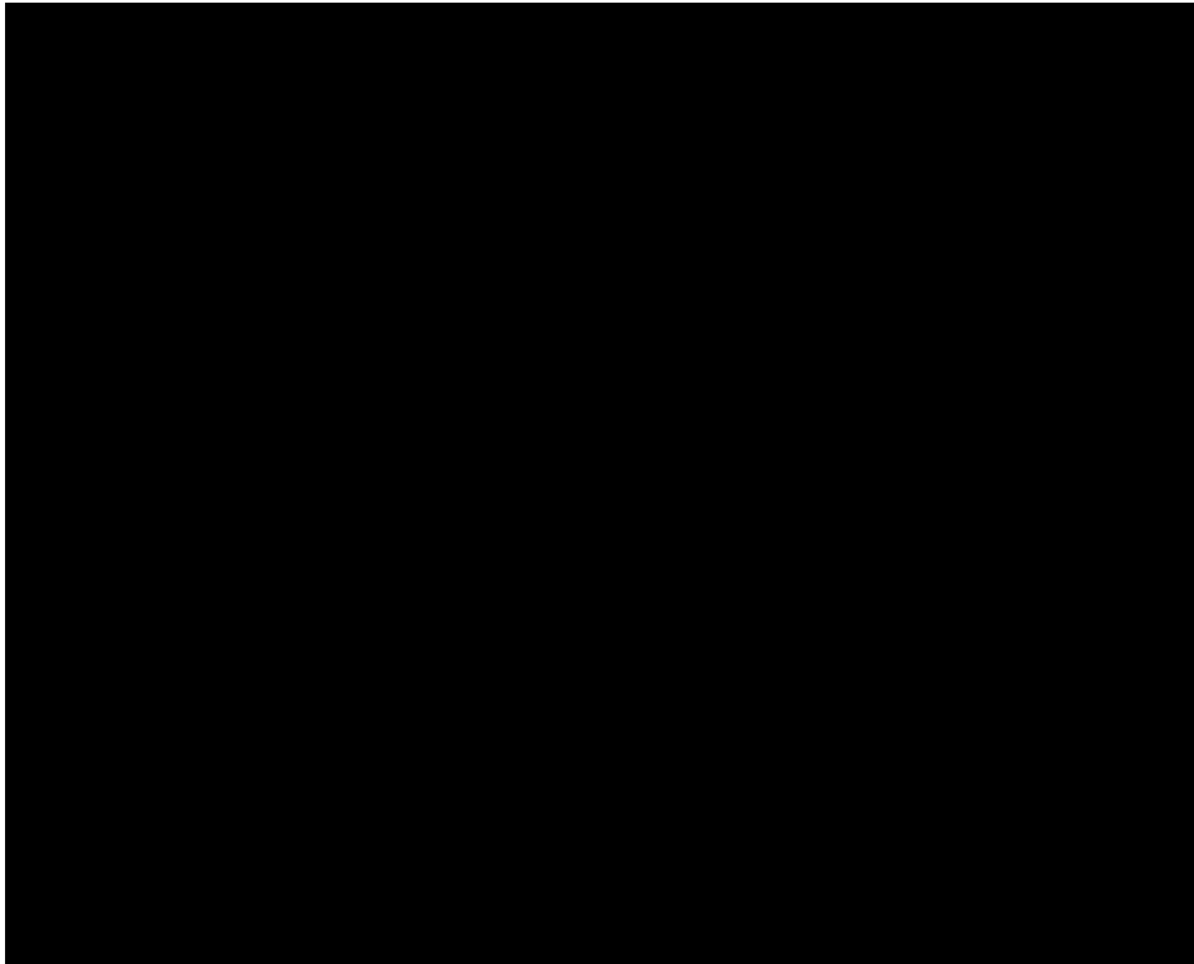

Bridge Street Substation is supplied by a single 115 kV line, the G192 from Power Street, which upon N-1 contingency causes an N-3 at the Bridge Street distribution substation. An alternative supply is available from a tap off the K165. A study needs to be completed to identify if 115 kV breakers can be added at Bridge Street Substation at the terminals of the G192 and K165 to address the Transmission N-1 design violation.

New Hampshire Design Violations Summary Report

Solution – Transformer Replacement

In-Service Date: June 1, 2026

- Replace the existing transformers at Bridge Street Substation with two 62.5 MVA units to resolve the N-1 STE violation and add a bus tie breaker to address the N-1 Bus violation.

	Planning Study	Initial Funding	SDC Presentation	SDC Approval	EPAC Full Funding
Planned	Nashua Area 5/1/2021	3/1/2021	4/1/2023	5/1/2023	5/1/2024
Actual					

Solution – Transmission N-1

In-Service Date: June 1, 2026

Solution to be determined within Nashua Area Planning Study.

	Planning Study	Initial Funding	SDC Presentation	SDC Approval	EPAC Full Funding
Planned	Nashua Area 5/1/2021	3/1/2021	4/1/2023	5/1/2023	5/1/2024
Actual					

REDACTED

New Hampshire Design Violations Summary Report

Bridge Street 4kV

1 Jackson Square, Nashua, NH

Bridge Street 4kV Substation is a 115-4.16 kV switchgear bulk substation with a single 10.5 MVA transformer and six distribution feeders. The distribution bus is operated as a single bus but does include a bus tie breaker.

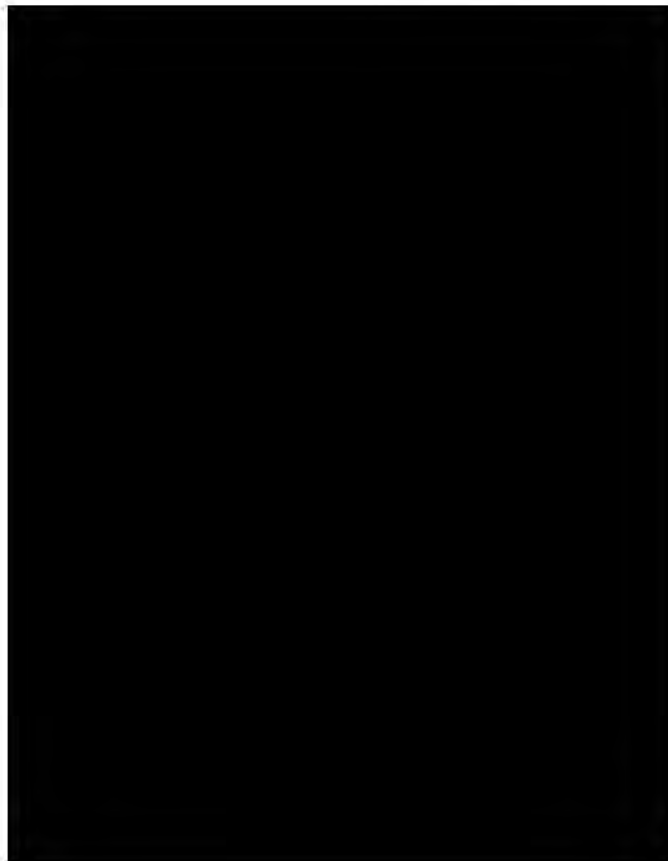
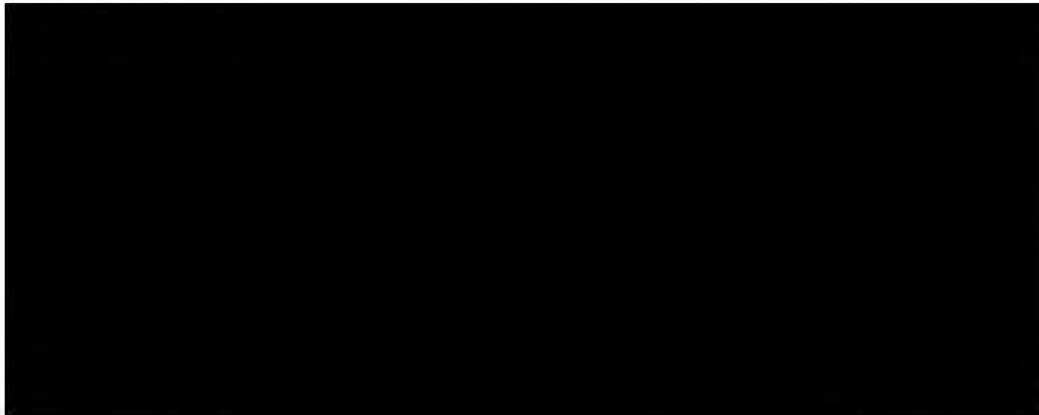

New Hampshire Design Violations Summary Report

Loading and Capacity

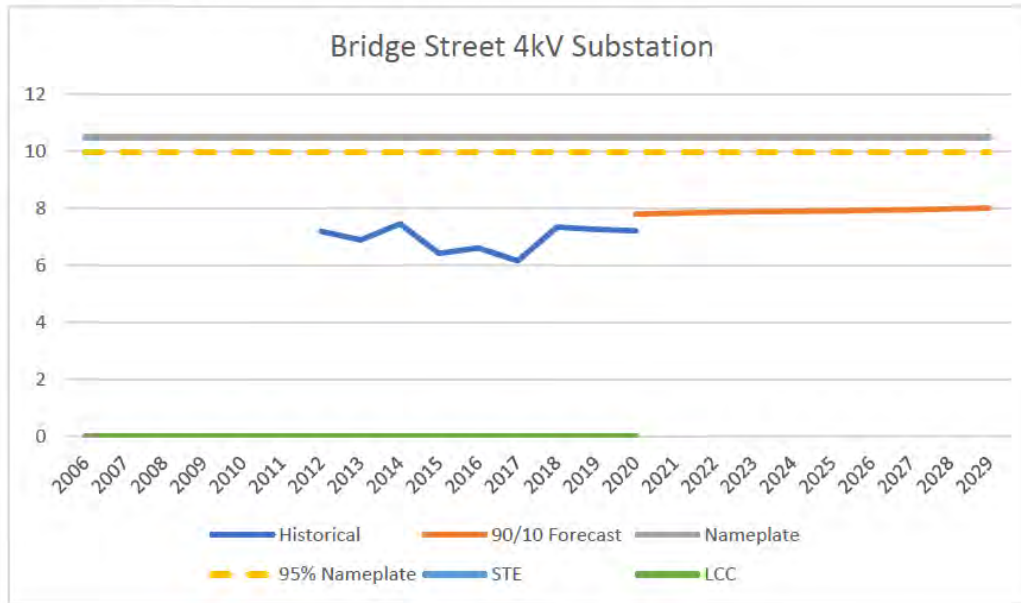

Distribution Company	Customers
Eversource Energy	2,435
Total Customers	2,435

	Mfg. Year	Condition Code ¹	Nameplate	LTE	STE	LCC
TB15C	2007	1 - Green	10.5	13	15	
Substation			10.5			0.0

Note 1: Transformer condition code as of May 2020.

System Planning Violations & Needs

	N-0 Base Load	N-1 Transformer	N-1 STE	N-1 Bus	N-1 Bus Tie	N-1 Transmission
First Year	10+	2020	n/a	2020	2020	n/a
Deficit	None	7.8 MW	n/a	7.8 MW	7.8 MW	n/a

Solution

Eversource’s plan is to address any substation contingency like that of a non-bulk substation and deploy a mobile 34.5-4.16 kV substation to Bridge Street Substation in an emergency scenario.

REDACTED

New Hampshire Design Violations Summary Report

Hudson

15 Power Street, Hudson, NH

Hudson Substation is a 115-34.5 kV open-air bulk substation with two 44.8 MVA transformers and six distribution feeders. Of the six feeders, four serve Eversource customers and two serve as express lines to Lawrence Road Substation. The distribution bus is operated as a single straight bus.



New Hampshire Design Violations Summary Report

Loading and Capacity

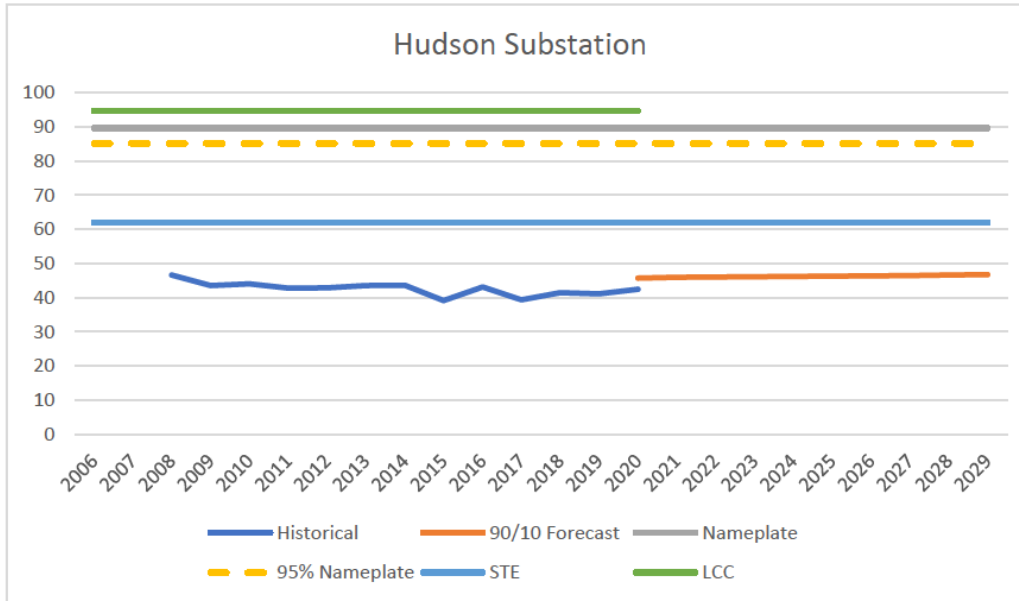

Distribution Company	Customers
Eversource Energy	12,011
Total Customers	12,011

	Mfg. Year	Condition Code ¹	Nameplate	LTE	STE	LCC
TB33	2005	1 – Green	44.8	53	62	
TB44	1974	1 – Green	44.8	48	63	
Substation			89.6		62	94.7

Note 1: Transformer condition code as of May 2020.

Thermal Rating Limitations

TB44 – Summer LTE is restricted to 48 MVA due to limitations with CT #Lower-Inner. The transformer is calculated to be able to sustain a 54 MVA Summer LTE rating.

System Planning Violations & Needs

	N-0 Base Load	N-1 Transformer	N-1 STE	N-1 Bus	N-1 Bus Tie	N-1 Transmission
First Year	10+	10+	10+	2020	n/a	n/a
Deficit	None	None	None		n/a	n/a

Solution – Load Transfer or Series Bus Tie Breakers Addition

In-Service Date: 6/1/2021 (load transfer) or 6/1/2026 (series bus tie breakers)

Study needs to determine if transferring the 3211 feeder to Lawrence Road is a possible solution to decrease the number of load blocks required for restoration during N-1 Bus Fault. Otherwise, installation of series bus tie breakers at Hudson Substation will resolve the design violation.

	Planning Study	Initial Funding	SDC Presentation	SDC Approval	EPAC Full Funding
Planned	Nashua Area 5/1/2021	3/1/2021	4/1/2024	5/1/2024	5/1/2025
Actual					

REDACTED

New Hampshire Design Violations Summary Report

Lawrence Road

34 Lawrence Road, Hudson, NH

Lawrence Road Substation is a 345-34.5 kV open-air bulk substation with a single 140 MVA transformer and five distribution feeders. Of the five feeders, three serve Eversource customers and two serve as express lines to Hudson Substation. The distribution bus is operated as a single straight bus.

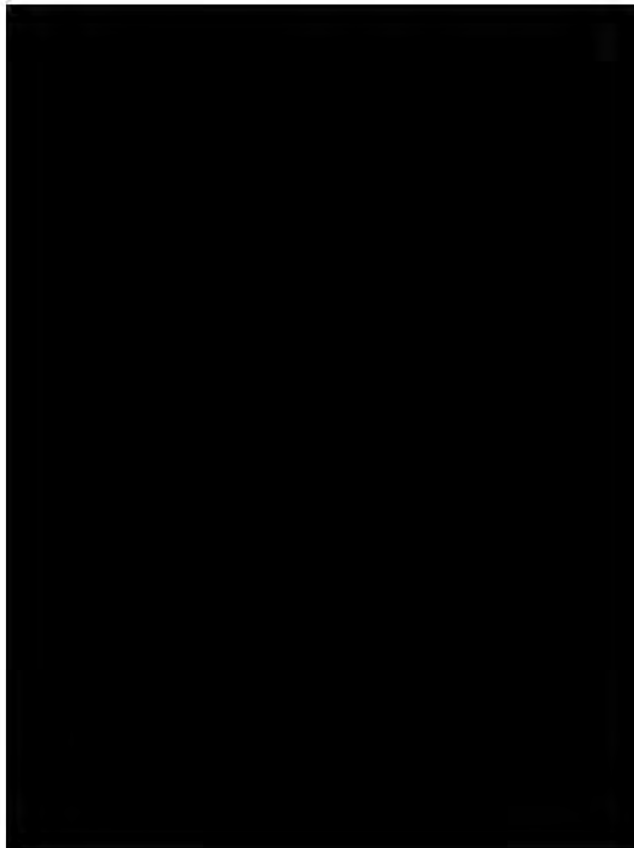
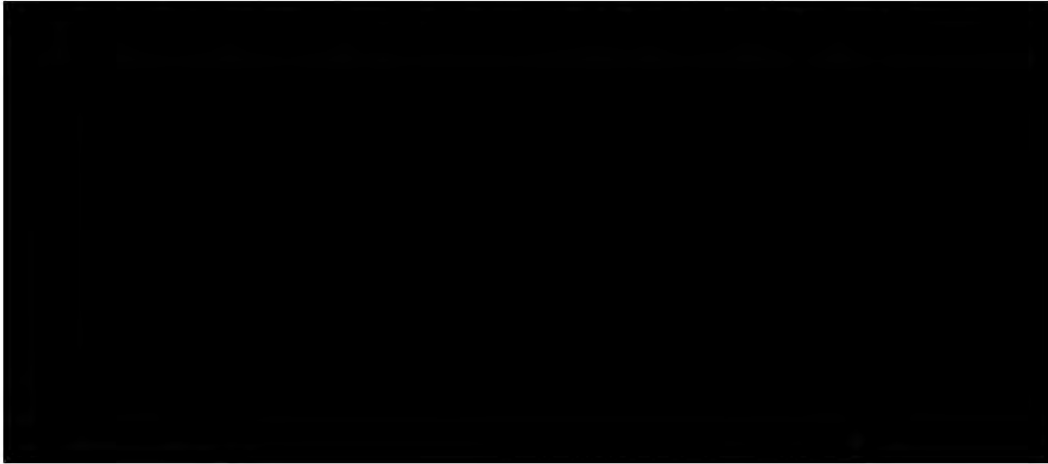

New Hampshire Design Violations Summary Report

Loading and Capacity

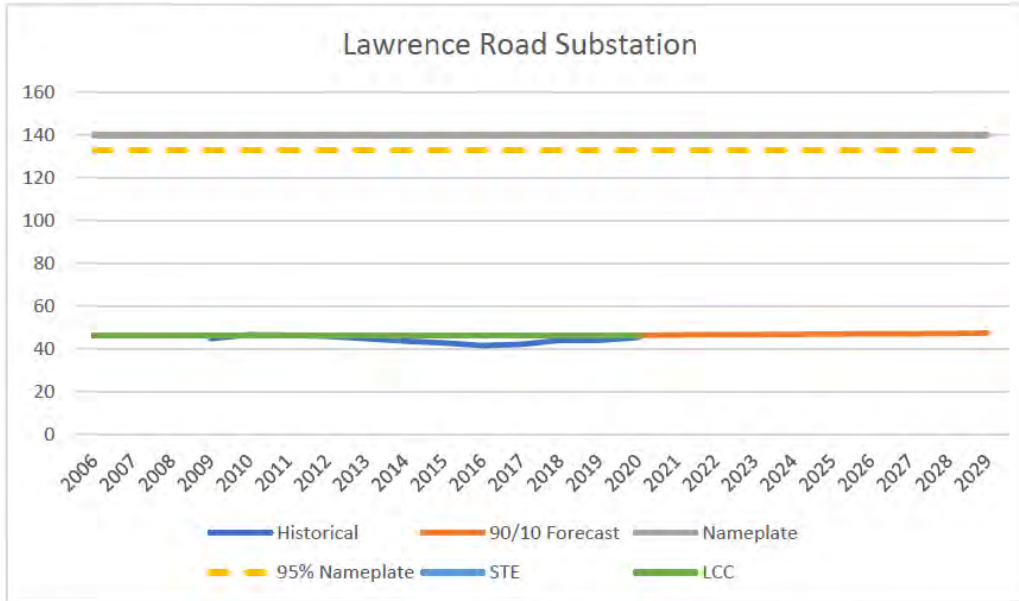

Distribution Company	Customers
Eversource Energy	7,437
Total Customers	7,437

	Mfg. Year	Condition Code ¹	Nameplate	LTE	STE	LCC
TB48	1995	1 – Green	140.0	178	201	
Substation			140.0			46.3

Note 1: Transformer condition code as of May 2020.

Thermal Rating Limitations

TB48 – Summer STE is restricted to 201 MVA due to limitations with CT #4. The transformer is calculated to be able to sustain a 210 MVA Summer STE rating.

System Planning Violations & Needs

	N-0 Base Load	N-1 Transformer	N-1 STE	N-1 Bus	N-1 Bus Tie	N-1 Transmission
First Year	10+	2021	n/a	2021	n/a	n/a
Deficit	None	0.2 MW	n/a	0.2 MW	n/a	n/a

Solution – Transformer Breaker Addition

In-Service Date: June 1, 2024

- Add a transformer breaker to Lawrence Road Substation to address the N-1 Transformer contingency. This allows for utilization of the Hudson express lines and the Lawrence Road bus for restoration.

	Planning Study	Initial Funding	SDC Presentation	SDC Approval	EPAC Full Funding
Planned	Lawrence Road 8/1/2021	3/1/2021	4/1/2022	5/1/2022	5/1/2023
Actual					

Solution – N-1 Bus Contingency

In-Service Date: June 1, 2026

The Nashua Area Study needs to determine if a bus tie breaker or additional capacity at neighboring stations will address the N-1 Bus Fault.

	Planning Study	Initial Funding	SDC Presentation	SDC Approval	EPAC Full Funding
Planned	Nashua Area 5/1/2021	3/1/2021	4/1/2023	5/1/2023	5/1/2024
Actual					

REDACTED

New Hampshire Design Violations Summary Report

Long Hill

81 Daniel Webster Highway, Nashua, NH

Long Hill Substation is a 115-34.5 kV open-air bulk substation with two 44.8 MVA transformers and four distribution feeders. Of the four feeders, three serve Eversource customers and one serves an out of service line. The distribution bus is operated as a single straight bus. The substation is supplied by a single, radial transmission line from Power Street Substation.

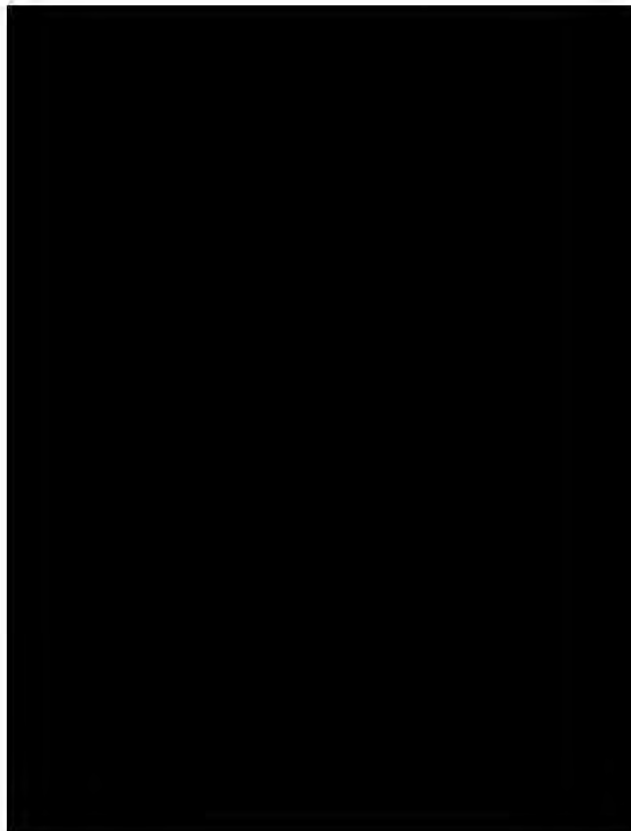
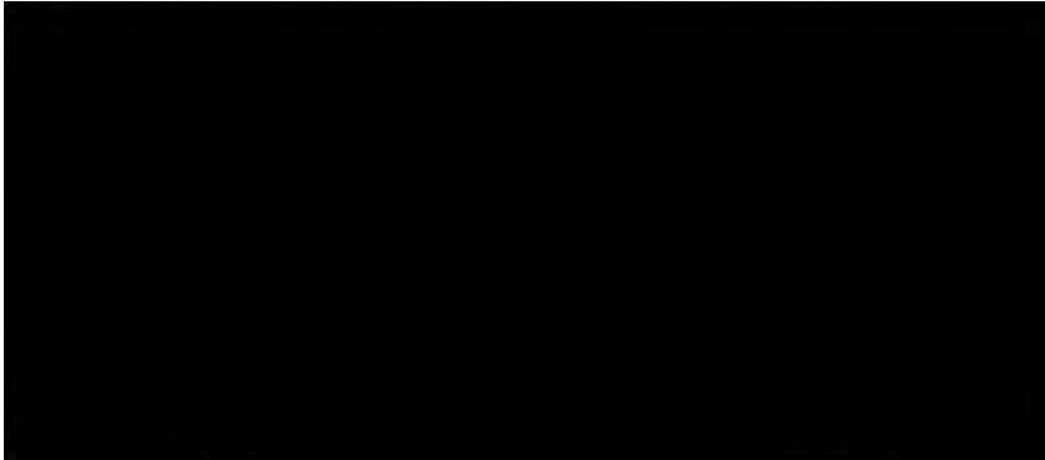

New Hampshire Design Violations Summary Report

Loading and Capacity

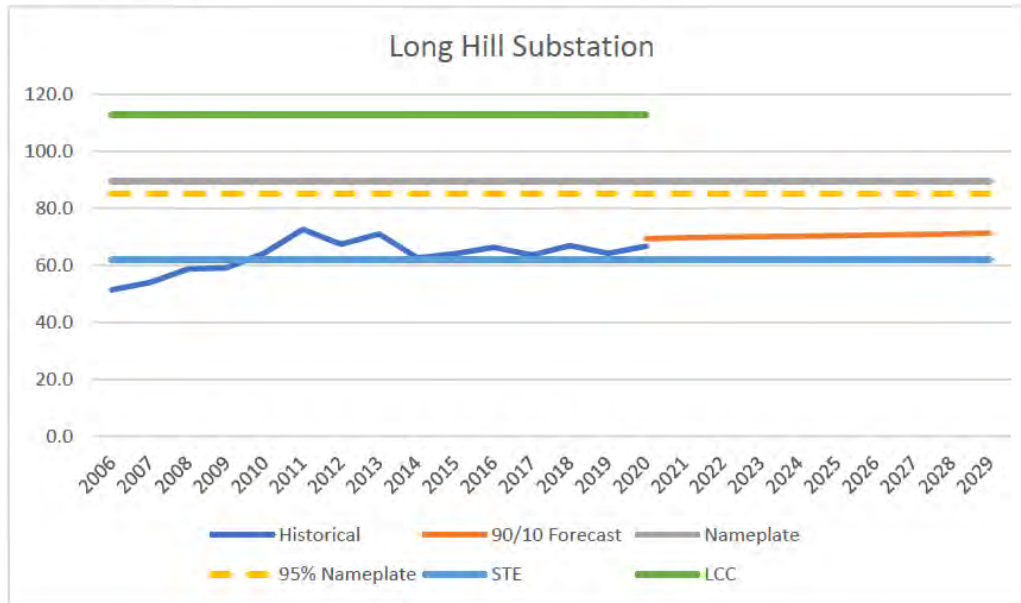

Distribution Company	Customers
Eversource Energy	18,153
Total Customers	18,153

	Mfg. Year	Condition Code ¹	Nameplate	LTE	STE	LCC
TB10	2005	1 – Green	44.8	53	62	
TB20	1969	2 – Yellow	44.8	56	62	
Substation			89.6		62	112.9

Note 1: Transformer condition code as of May 2020.

REDACTED

New Hampshire Design Violations Summary Report

System Planning Violations & Needs

	N-0 Base Load	N-1 Transformer	N-1 STE	N-1 Bus	N-1 Bus Tie	N-1 Transmission
First Year	10+	10+	2020	2020	n/a	2020
Deficit	None	None	7.4 MW	17.3 MW	n/a	

Transmission N-1 Design Violation

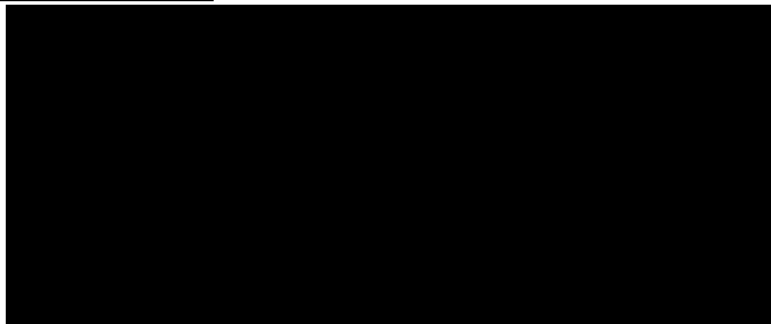

As part of the South Milford Substation solution, a new transmission line to bring in a second supply may come from Long Hill. If this route is chosen, it will address the Transmission N-1 design violation at Long Hill Substation.

Solution – Transformer Replacement

In-Service Date: June 1, 2027

- Replace the existing transformers at Long Hill Substation with two 62.5 MVA units to address N-1 STE design violation.
- Add series bus tie breakers to address N-1 Bus Fault design violation.

	Planning Study	Initial Funding	SDC Presentation	SDC Approval	EPAC Full Funding
Planned	Nashua Area 5/1/2021	3/1/2021	4/1/2025	5/1/2025	5/1/2026
Actual					

REDACTED

New Hampshire Design Violations Summary Report

Scobie Pond

12 Scobie Pond Road, Derry, NH

Scobie Pond (Distribution) Substation is a 115-12.47 kV switchgear bulk substation with two 30 MVA transformers and six distribution feeders. Of the six feeders, five serve Eversource customers and one is a spare position for future use. The distribution bus is operated with an open bus tie breaker. The substation is supplied by a single transmission line from the Scobie Pond 115 kV yard.

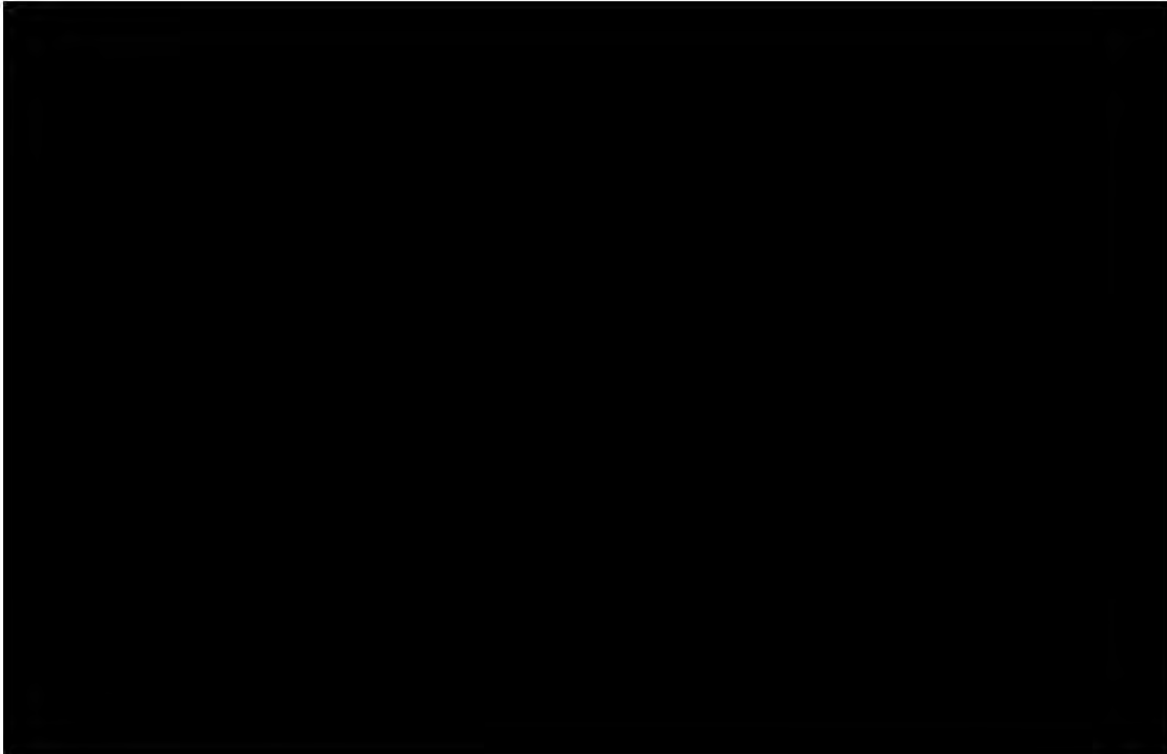
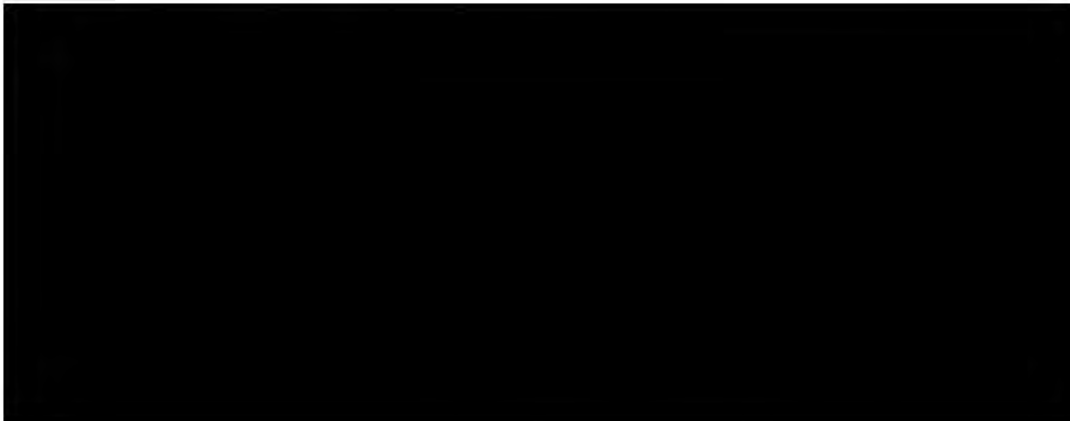

New Hampshire Design Violations Summary Report

Loading and Capacity

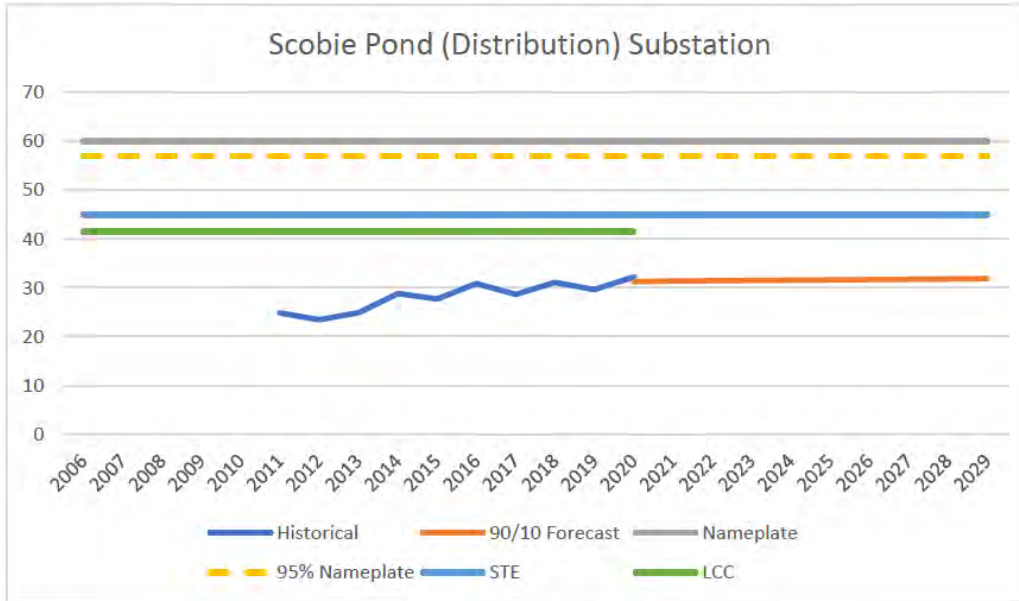

Distribution Company	Customers
Eversource Energy	9,510
New Hampshire Electric Cooperative	1,444
Total Customers	10,954

	Mfg. Year	Condition Code ¹	Nameplate	LTE	STE	LCC
TB131	2011	1 – Green	30.0	35	45	
TB132	2011	1 – Green	30.0	36	45	
Substation			60.0		45	41.5

Note 1: Transformer condition code as of May 2020.

REDACTED

New Hampshire Design Violations Summary Report

System Planning Violations & Needs

	N-0 Base Load	N-1 Transformer	N-1 STE	N-1 Bus	N-1 Bus Tie	N-1 Transmission
First Year	10+	10+	10+	2020	2020	2020
Deficit	None	None	None	10.3 MW		

Transmission N-1 Design Violation

System Planning recognizes the design violation of the Transmission N-1 (loss of the N124) causing an N-2 for the distribution substation. The N124 is entirely contained within the property of Scobie Pond Substation. If an outage were to occur on the N124, Eversource personnel would patrol the substation and have System Operations restore the distribution load via the alternate supply of the B172 line. Distribution System Planning is not pursuing any capital investment to resolve this design violation due to the limited exposure to a transmission outage and the availability of the alternative supply.

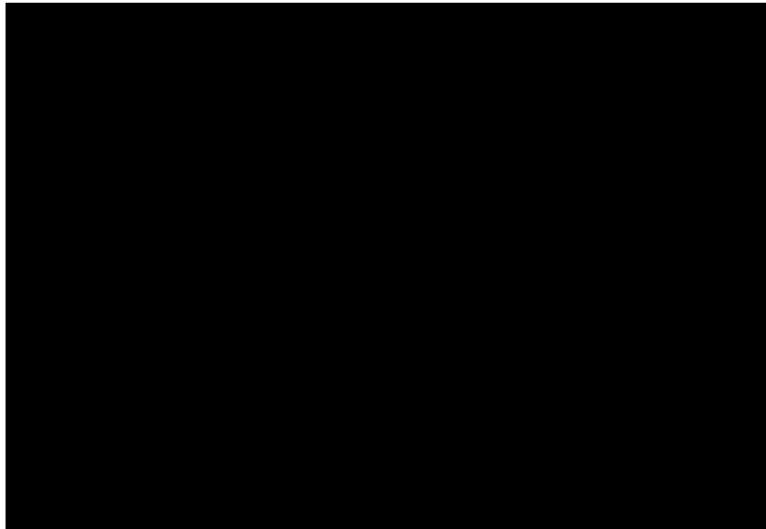

New Hampshire Design Violations Summary Report

Solution – Distribution System Improvements

In-Service Date: June 1, 2024

- Enhance the 12.47 kV distribution system to increase line capacity to address N-1 Bus Fault design violation.
- Add series bus tie breakers to Scobie Pond Substation to address N-1 bus tie breaker failure.

	Planning Study	Initial Funding	SDC Presentation	SDC Approval	EPAC Full Funding
Planned	Scobie Pond 11/1/2021	3/1/2021	4/1/2022	5/1/2022	5/1/2023
Actual					

REDACTED

New Hampshire Design Violations Summary Report

South Milford

4 Hammond Road, Milford, NH

South Milford Substation is hybrid 115-34.5 kV open-air bulk substation and 34.5 kV switching station. A single 44.8 MVA transformer supplies Bus 2 and two distribution feeders. Two distribution lines from Amherst Substation supply Bus 1 and three distribution feeders. The distribution bus is operated with an open bus tie breaker.

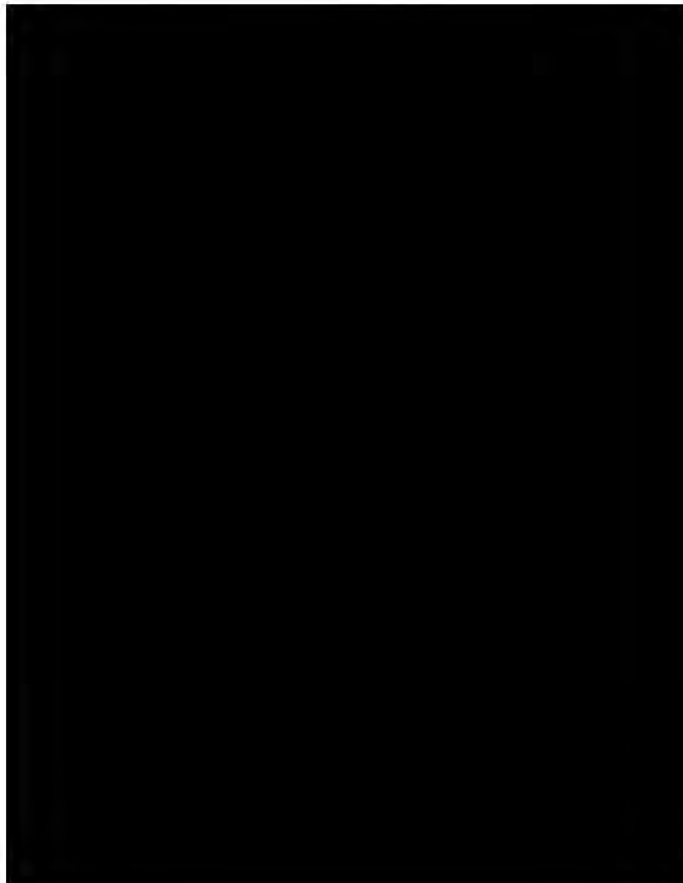
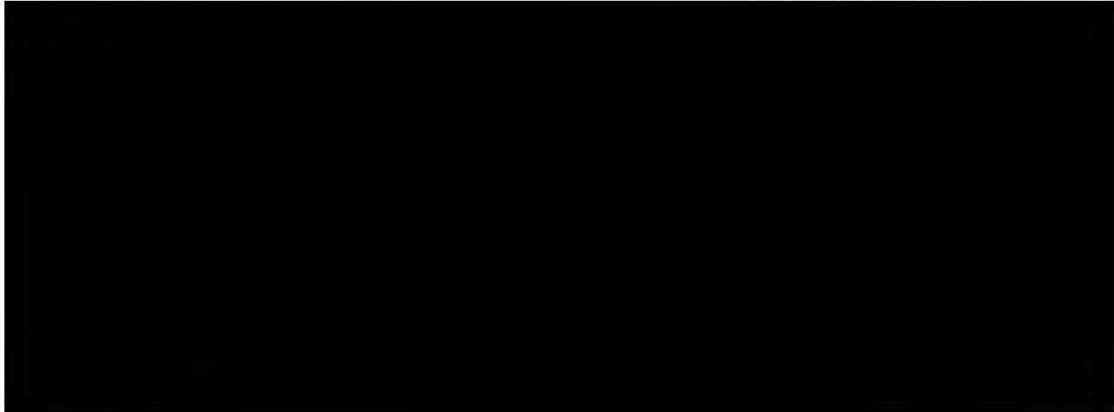

New Hampshire Design Violations Summary Report

Loading and Capacity (Bus 2)

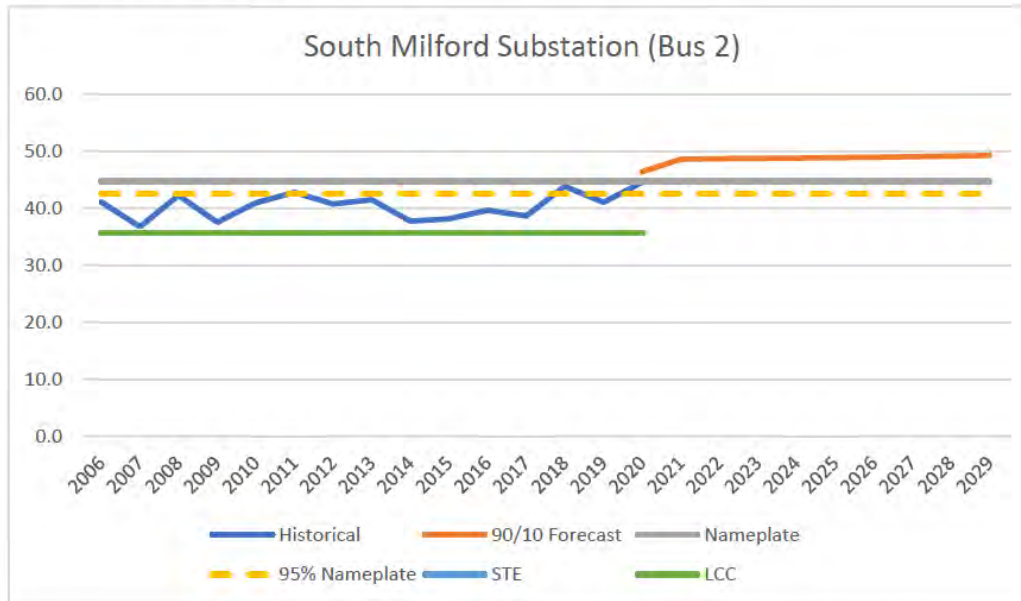

Distribution Company	Customers
Eversource Energy – Bus 1 (switching station)	12,191
Eversource Energy – Bus 2 (bulk substation)	13,608
Total Customers	25,799

	Mfg. Year	Condition Code ¹	Nameplate	LTE	STE	LCC
TB86	2014	1 – Green	44.8	55	67	
Substation			44.8			35.7

Note 1: Transformer condition code as of May 2020.

System Planning Violations & Needs

	N-0 Base Load	N-1 Transformer	N-1 STE	N-1 Bus	N-1 Bus Tie	N-1 Transmission
First Year	2020	2020	n/a	2020	2020	n/a
Deficit	3.8 MW	10.7 MW	n/a	10.7 MW		n/a

Solution – Transformer Replacement and Addition (A20S19)

In-Service Date: December 31, 2024

- Replace the existing transformer at South Milford Substation with a 62.5 MVA units to address base case loading design violation.
- Add a second 62.5 MVA transformer at South Milford Substation to address the N-1 Transformer Failure design violation.
- Construct a new feeder to offload the 314 feeder.
- Construct a new transmission line into South Milford to address the new Transmission N-1 design violation with installation of a second transformer. A routing of South Milford to Long Hill also addresses the Transmission N-1 design violation at Long Hill Substation.

	Planning Study	Initial Funding	SDC Presentation	SDC Approval	EPAC Full Funding
Planned	South Milford 12/31/2020	3/1/2021	10/1/2021	11/1/2021	11/1/2022
Actual	2/9/2021				

New Hampshire Design Violations Summary Report

BULK SUBSTATIONS – WESTERN REGION

REDACTED

New Hampshire Design Violations Summary Report

Chestnut Hill

138 Old Chesterfield Road, Hinsdale, NH

Chestnut Hill Substation is a 115-34.5 kV open-air bulk substation with two 12.5 MVA transformers and two distribution feeders. The distribution bus is operated with an open bus tie switch. Each transformer breaker is also utilized for feeder protection.

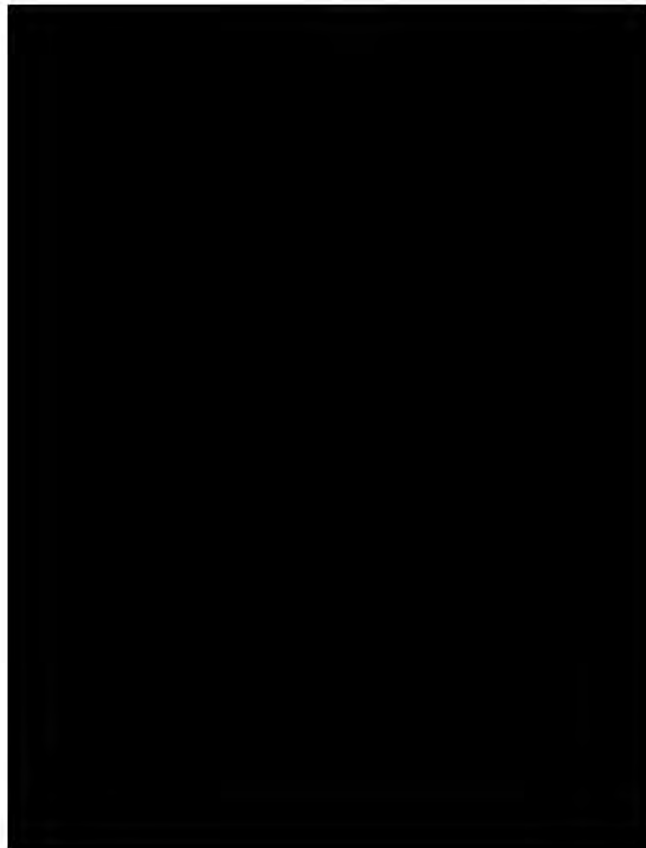

Loading and Capacity

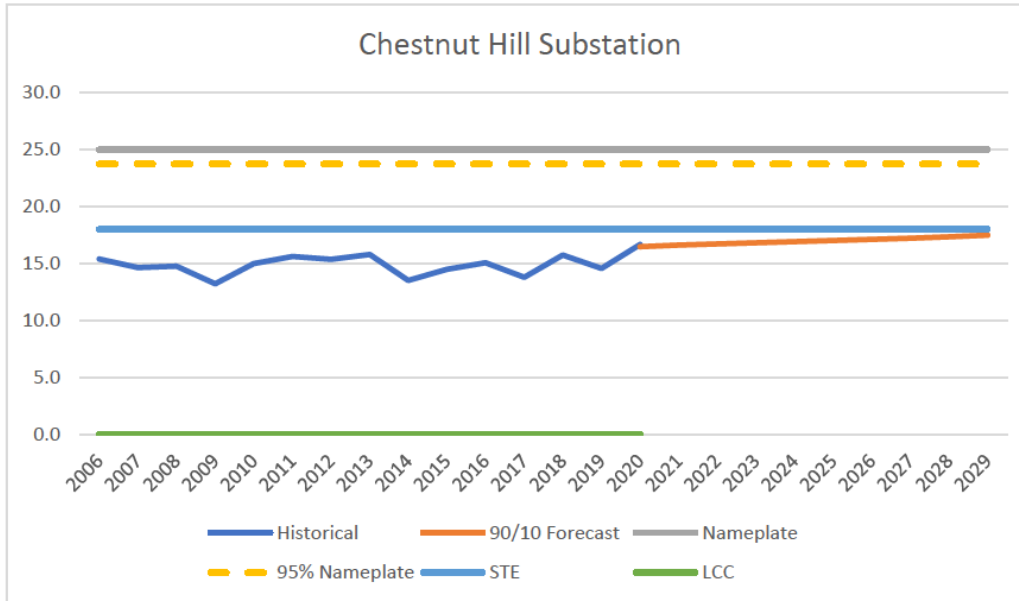

Distribution Company	Customers
Eversource Energy	6,895
Total Customers	6,895

	Mfg. Year	Condition Code ¹	Nameplate	LTE	STE ²	LCC
TB87	1947	2 – Yellow	12.5	16	18	
TB98	1947	2 – Yellow	12.5	16	18	
Substation			25.0		18	0.0

Note 1: Transformer condition code as of May 2020.

Note 2: Bus tie switch is operated normally open.

Thermal Rating Limitations

TB98 – Summer LTE is restricted to 16 MVA due to the requirement by System Operations to maintain a 2 MVA difference between LTE and STE. The transformer is calculated to be able to sustain an 18 MVA Summer LTE rating.

Condition Assessment

The dissolved gas analysis of the oil in TB98 indicates a history of overstressing the transformer paper insulation. This is evident from the high level of heat gases. The LTC compartment had a recent high production of electrical fault gases likely due to poor oil quality. The analysis of the oil indicate this is an unhealthy transformer due to the following factors:

- The main tank dissolved gas analysis has a history of thermal related faults to paper insulation
- The LTC dissolved gas analysis has signs of recent electrical faults
- Numerous repairs to the LTC drive components

System Planning Violations & Needs

	N-0 Base Load	N-1 Transformer	N-1 STE	N-1 Bus	N-1 Bus Tie	N-1 Transmission
First Year	10+	2020	10+	2020	n/a	n/a
Deficit	None	10.3 MW	None	10.3 MW	n/a	n/a

Solution – Transformer Replacement

In-Service Date: June 1, 2025

- Replace the existing transformers at Chestnut Hill Substation with two 44.8 MVA or 62.5 MVA units and add series bus tie breakers and two feeder breakers to address N-1 Transformer and N-1 Bus design violations.

	Planning Study	Initial Funding	SDC Presentation	SDC Approval	EPAC Full Funding
Planned	Chestnut Hill 4/1/2021	3/1/2021	4/1/2023	5/1/2023	5/1/2024
Actual					

REDACTED

New Hampshire Design Violations Summary Report

Emerald Street (Keene)

220 Emerald Street, Keene, NH

Emerald Street Substation (formerly known as Keene Substation) is a 115-12.47 kV switchgear bulk substation with two 12.5 MVA and three 22.4 MVA transformers and ten distribution feeders. TB12 has been out of service since April 30, 2017 due to poor results from a gas analysis. Currently underway is a project to address asset condition and under-duty switchgear, replacing the 12.47 kV switchgear and replacing the four older transformers with two 30 MVA transformers (TB3 remains post-project). The distribution bus is operated with an open bus tie breaker between Bus 1 and Bus 2, Bus 3 is electrically separate. The distribution bus in the new switchgear will also be three buses but will have two normally open bus ties.

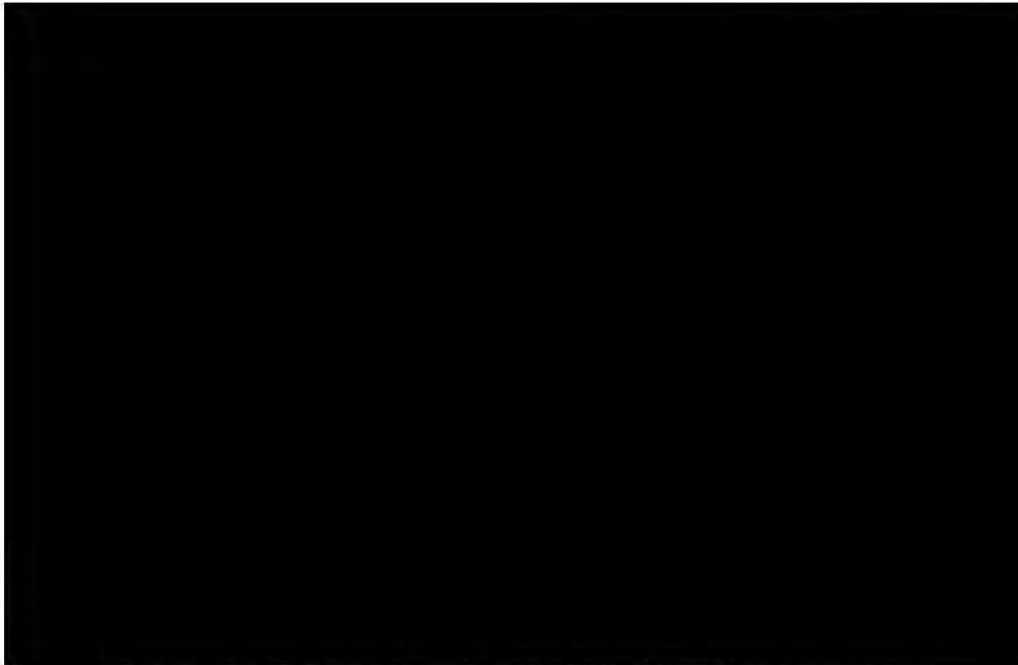

In progress one-line showing the new (supplied by TX3) and old switchgear arrangements.

New Hampshire Design Violations Summary Report

Loading and Capacity

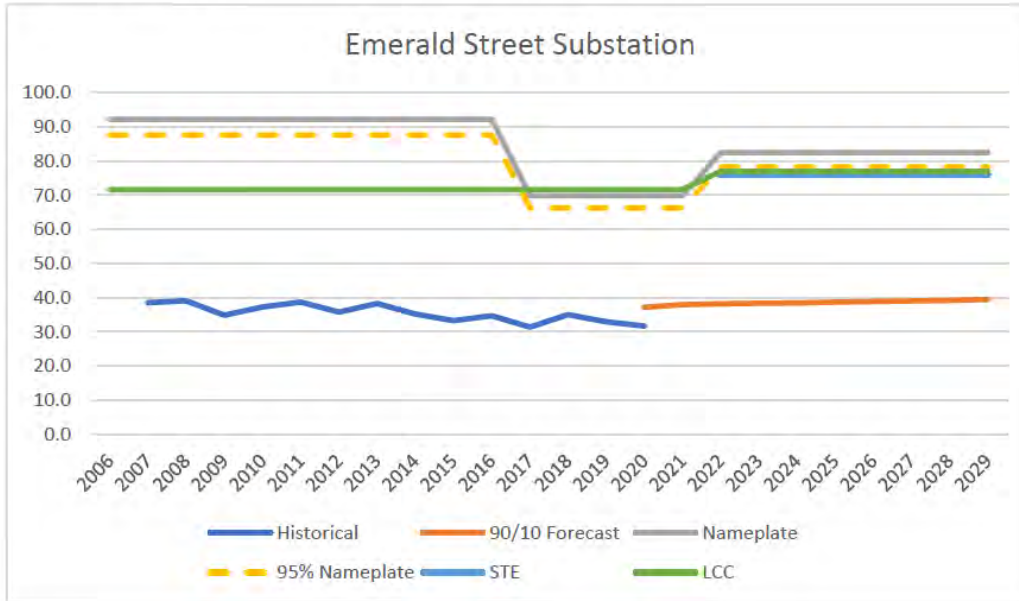

Distribution Company	Customers
Eversource Energy	8,723
Total Customers	8,723

Pre-Project	Mfg. Year	Condition Code ¹	Nameplate	LTE	STE ²	LCC
TB3	2000	1 – Green	22.4	26	33	
TB7	1964	3 – Orange	22.4	27	32	
TB12 - OOS	1969	3 – Orange	22.4	N/A	N/A	
TB18	1953	2 - Yellow	12.5	16	18	
TB23	1954	2 - Yellow	12.5	15	18	
Substation			92.2			71.6
Post-Project	Mfg. Year	Condition Code ¹	Nameplate	LTE	STE ³	LCC
TX3	2000	1 – Green	22.4	27	33	
TX123	2018	N/A	30.0	37	45	
TX136	2018	N/A	30.0	38	45	
Substation			82.4		78	77.0

Note 1: Transformer condition code as of May 2020.

Note 2: Automatic bus restoral scheme, bus tie 1200 auto closes for loss of TB7 or TB12.

Note 3: Automatic bus restoral scheme, BT12 or TB23 auto closes based on seasonal limits.

Thermal Rating Limitations

TX3 – Summer LTE is restricted to 26 MVA due to limitations with CT #4. The transformer is calculated to be able to sustain a 27 MVA Summer LTE rating.

TX123 – Summer STE is restricted to 43 MVA due to limitations with CT #29. The transformer is calculated to be able to sustain a 45 MVA Summer LTE rating.

TX136 – Summer STE is restricted to 43 MVA due to limitations with CT #16. The transformer is calculated to be able to sustain a 45 MVA Summer LTE rating.

System Planning Violations & Needs

	N-0 Base Load	N-1 Transformer	N-1 STE	N-1 Bus	N-1 Bus Tie	N-1 Transmission
First Year	10+	10+	10+	10+	2020	n/a
Deficit	None	None	None	None		n/a

Solution – Emerald Street Rebuild (D: A14W01, T: T1347A)

In-Service Date: December 31, 2021

- Replace 12.47 kV switchgear due to being overdutied.
- Replace four poor condition transformers with two 30 MVA transformers

	Planning Study	Initial Funding	SDC Presentation	SDC Approval	EPAC Full Funding
Planned	n/a	n/a	n/a	n/a	n/a
Actual	5/2/2012	N/A	n/a	2/4/2019	4/25/2018

Solution – N-1 Bus Tie Breaker Failure

In-Service Date: TBD

At the time of design and construction, N-1 bus tie breaker failure was not a studied contingency. The new single-bus switchgear will not pass Eversource’s new design criteria.

Solution to be determined.

	Planning Study	Initial Funding	SDC Presentation	SDC Approval	EPAC Full Funding
Planned	TBD	TBD	TBD	TBD	TBD
Actual					

REDACTED

New Hampshire Design Violations Summary Report

Jackman

8 Sawmill Road, Hillsborough, NH

Jackman Substation is a 115-34.5 kV open-air bulk substation with a 28 and a 44.8 MVA transformer and five distribution feeders. Of the five feeders, four serve Eversource customers and one is a feeder to Jackman Hydro. The distribution bus is operated as a single straight bus.

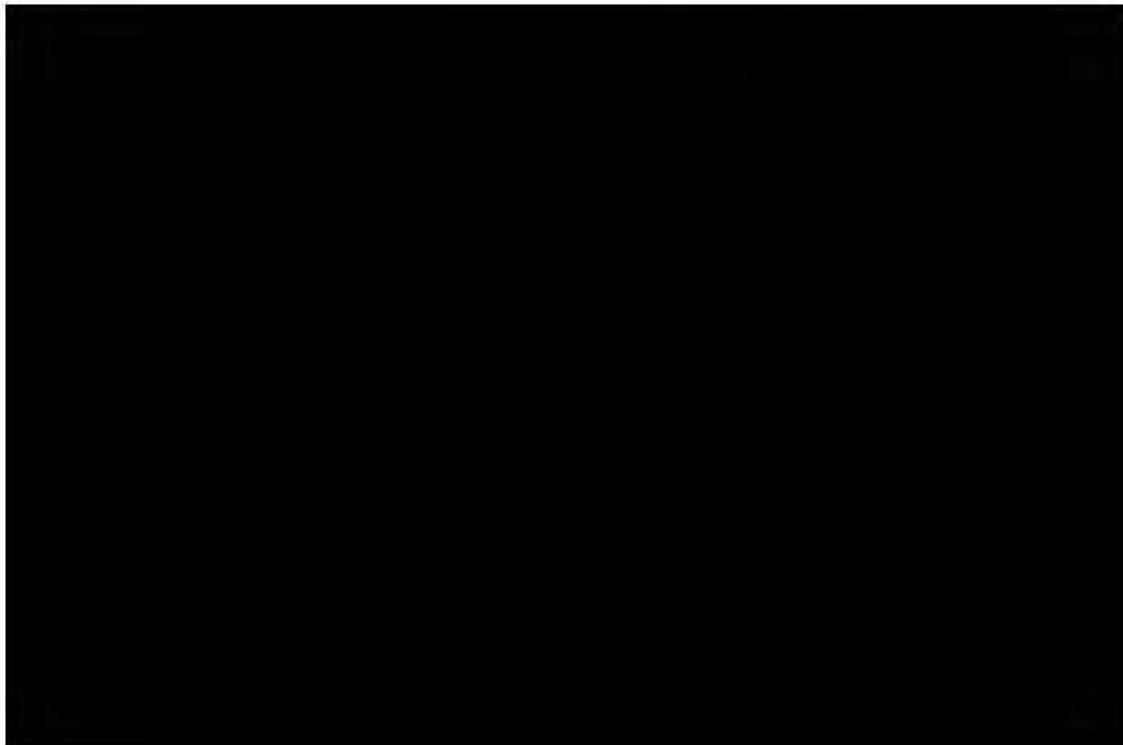

Loading and Capacity

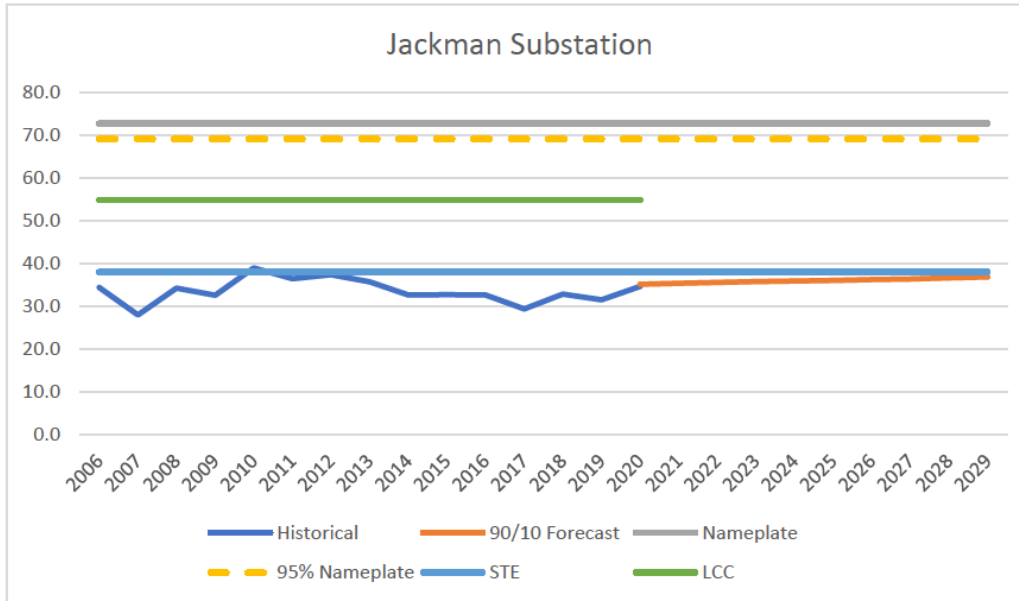

Distribution Company	Customers
Eversource Energy	17,006
Total Customers	17,006

	Mfg. Year	Condition Code ¹	Nameplate	LTE	STE ²	LCC
TB33	2008	1 – Green	44.8	57	67	
TB61	1964	2 – Yellow	28.0	34	38	
Substation			72.8		38	54.8

Note 1: Transformer condition code as of May 2020.

Note 2: Transformer protection scheme sheds feeder 3173 for loss of TB33.

Condition Assessment

The dissolved gases found in this oil are above average. Most recently showing evidence of thermal stressing of the transformer oil. There is also a history of thermal stress of the paper insulation. Analysis of the oil indicates this is an unhealthy transformer due to the following factors:

- The main tank dissolved gas analysis has a history of thermal related faults to the transformer oil and paper insulation
- The main tank oil quality is fair showing signs of polar contaminants
- The main tank furans test reveals the degree of polymerization is very low

New Hampshire Design Violations Summary Report

Miscellaneous items:

- Leaking Barrier board/gaskets
- Numerous repairs to LTC drive components

System Planning Violations & Needs

	N-0 Base Load	N-1 Transformer	N-1 STE	N-1 Bus	N-1 Bus Tie	N-1 Transmission
First Year	10+	10+	10+	2020	n/a	n/a
Deficit	None	None	None		n/a	n/a

Solution – Series Bus Tie Breakers Addition

In-Service Date: June 1, 2026

- Add series bus tie breakers to address N-1 Bus Fault design violation.

	Planning Study	Initial Funding	SDC Presentation	SDC Approval	EPAC Full Funding
Planned	Jackman 7/1/2021	3/1/2021	4/1/2024	5/1/2024	5/1/2025
Actual					

REDACTED

New Hampshire Design Violations Summary Report

Monadnock

189 Monadnock Street, Troy, NH

Monadnock Substation is a 115-34.5 kV open-air bulk substation with a 20 and a 28 MVA transformer and three distribution feeders. The distribution bus is operated with a closed bus tie breaker.

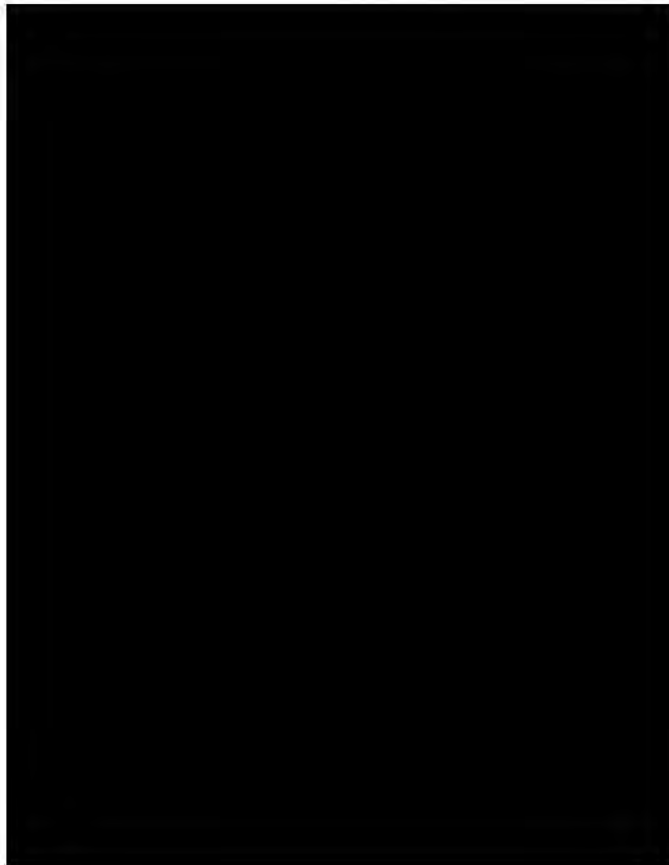
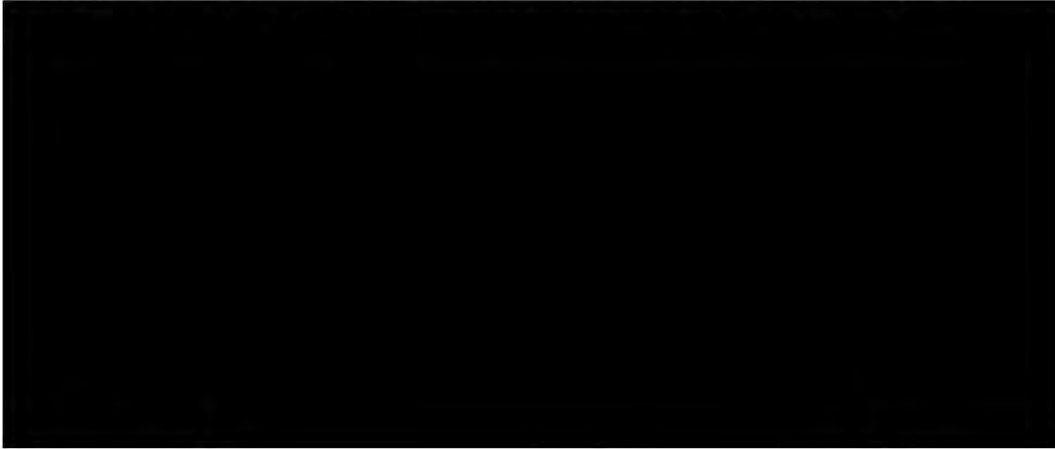

Loading and Capacity

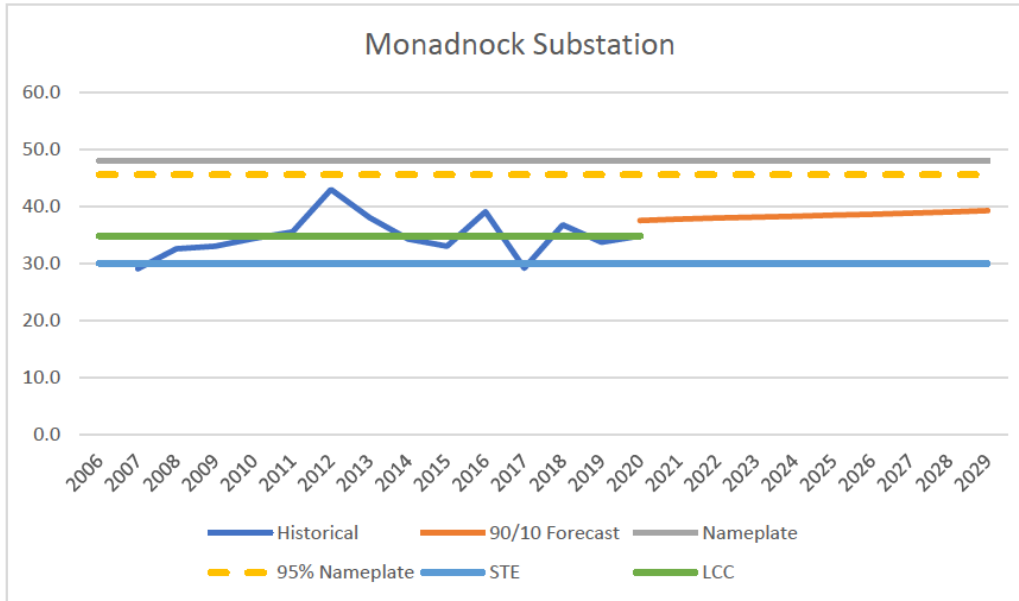

Distribution Company	Customers
Eversource Energy	12,903
Total Customers	12,903

	Mfg. Year	Condition Code ¹	Nameplate	LTE	STE ²	LCC
TB40	1951	3 – Orange	20.0	28	30	
TB80	1965	1 – Green	28.0	34	38	
Substation			48.0		30	34.8

Note 1: Transformer condition code as of May 2020.

Note 2: With no 34.5 kV transformer breakers on TB40 and TB80, a transformer fault isolates its respective distribution bus. Line ties then automatically close restoring some load.

Thermal Rating Limitations

TB40 – Summer LTE is restricted to 28 MVA due to the requirement by System Operations to maintain a 2 MVA difference between LTE and STE. The transformer is calculated to be able to sustain a 30 MVA Summer LTE rating.

System Planning Violations & Needs

	N-0 Base Load	N-1 Transformer	N-1 STE	N-1 Bus	N-1 Bus Tie	N-1 Transmission
First Year	10+	2020	2020	2020	2020	n/a
Deficit	None	2.7 MW	7.5 MW	5.5 MW		n/a

Solution – Transformer Replacement (D: A18W06, T: T1402A)

In-Service Date: December 31, 2023

- Replace the existing transformers at Monadnock Substation with two 44.8 MVA or 62.5 MVA units to address N-1 Transformer, N-1 STE, and N-1 bus fault design violations.
- Add series bus tie breakers to address N-1 bus tie breaker failure design violation.

	Planning Study	Initial Funding	SDC Presentation	SDC Approval	EPAC Full Funding
Planned	N/A	N/A	10/30/2021	11/30/2021	11/30/2022
Actual		6/12/2019			

REDACTED

New Hampshire Design Violations Summary Report

North Keene

115 Park Avenue, Keene, NH

Lawrence Road Substation is a 345-34.5 kV open-air bulk substation with a single 140 MVA transformer and five distribution feeders. Of the five feeders, three serve Eversource customers and two serve as express lines to Hudson Substation. The distribution bus is operated as a single straight bus.

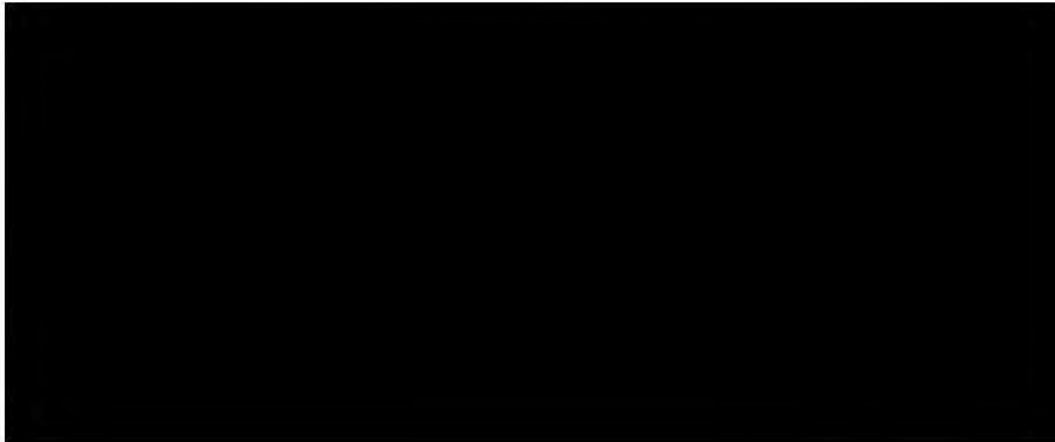

New Hampshire Design Violations Summary Report

Loading and Capacity

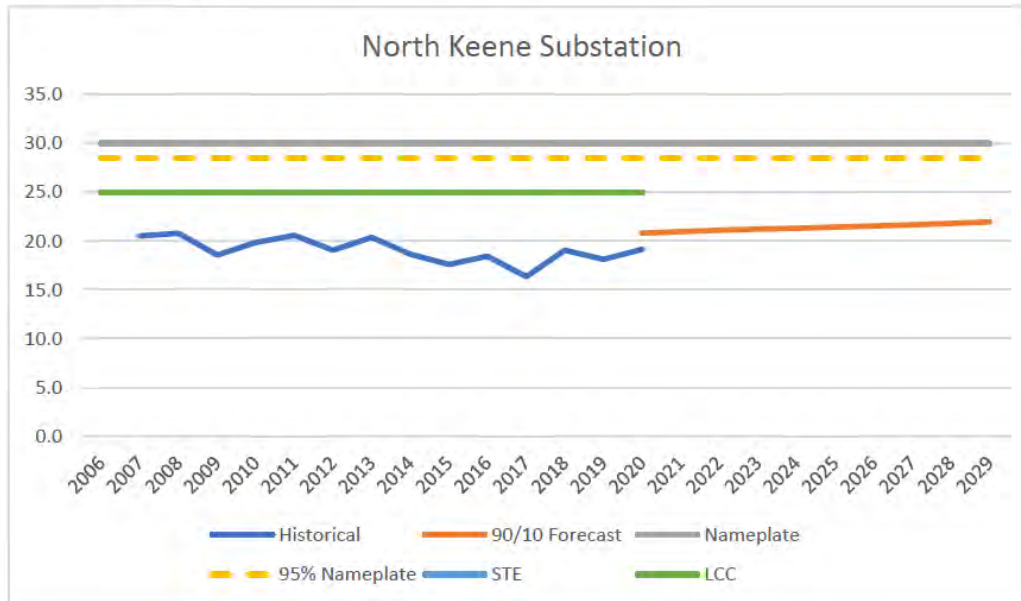

Distribution Company	Customers
Eversource Energy	7,870
Total Customers	7,870

	Mfg. Year	Condition Code ¹	Nameplate	LTE	STE	LCC
TB145	2015	1 – Green	30.0	36	45	
Substation			30.0			25.0

Note 1: Transformer condition code as of May 2020.

System Planning Violations & Needs

	N-0 Base Load	N-1 Transformer	N-1 STE	N-1 Bus	N-1 Bus Tie	N-1 Transmission
First Year	10+	10+	n/a	2020	2020	n/a
Deficit	None	None	n/a	6.2 MW		n/a

Solution – Distribution SCADA

In-Service Date: June 1, 2022

- Replace the manual 76W1DX2 disconnect switch with a SCADA-controlled device in order to restore load on the radial 76W7 feeder.

REDACTED

New Hampshire Design Violations Summary Report

North Road

74 North Road, Sunapee, NH

North Road Substation is a 115-34.5 kV open-air bulk substation with two 44.8 MVA transformer and four distribution feeders. Of the four feeders, three serve Eversource customers and one is a feeder to New Hampshire Electric Cooperative's Sunapee Substation. The distribution bus is operated as a single straight bus.

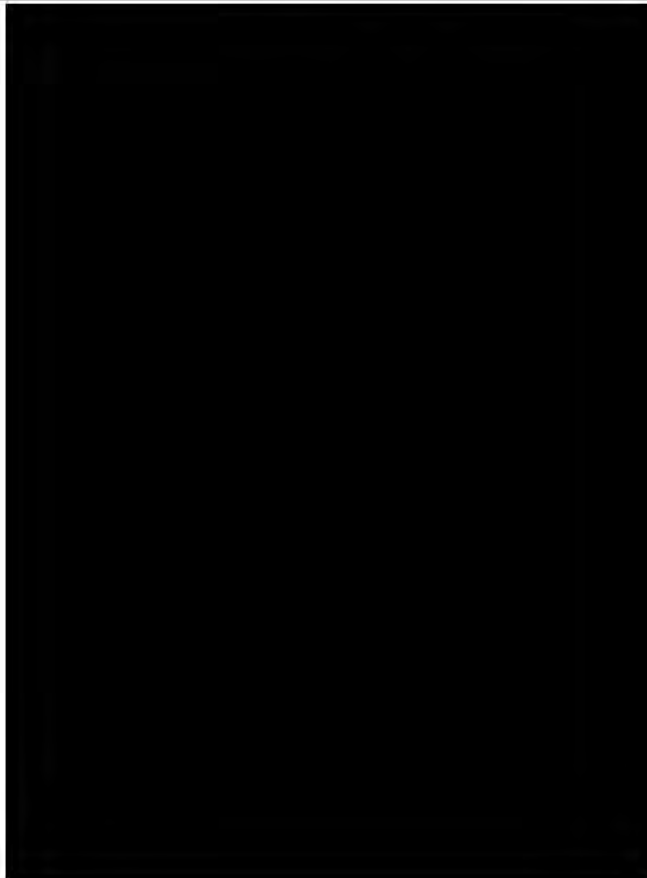

New Hampshire Design Violations Summary Report

Loading and Capacity

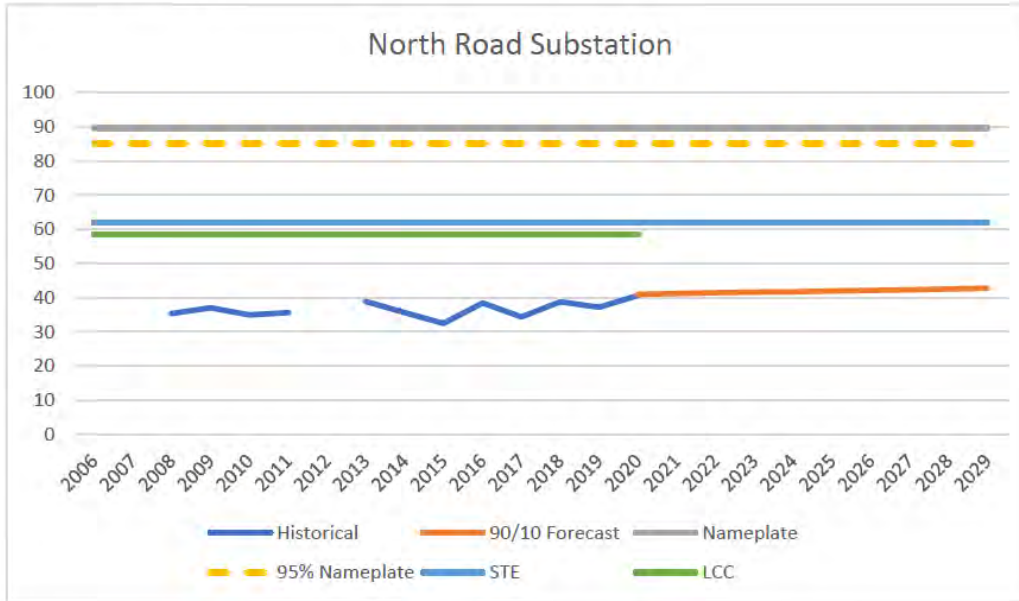

Distribution Company	Customers
Eversource Energy	16,902
New Hampshire Electric Cooperative	3,147
Total Customers	20,049

	Mfg. Year	Condition Code ¹	Nameplate	LTE	STE	LCC
TB38	1971	2 – Yellow	44.8	56	62	
TB49	1971	2 – Yellow	44.8	56	62	
Substation			89.6		62	58.5

Note 1: Transformer condition code as of May 2020.

System Planning Violations & Needs

	N-0 Base Load	N-1 Transformer	N-1 STE	N-1 Bus	N-1 Bus Tie	N-1 Transmission
First Year	10+	10+	10+	2020	n/a	n/a
Deficit	None	None	None	38.4 MW	n/a	n/a

Solution – Series Bus Tie Breakers Addition

In-Service Date: June 1, 2026

- Add series bus tie breakers to address N-1 Bus Fault design violation.

	Planning Study	Initial Funding	SDC Presentation	SDC Approval	EPAC Full Funding
Planned	North Road 10/1/2021	3/1/2021	4/1/2024	5/1/2024	5/1/2025
Actual					

New Hampshire Design Violations Summary Report

NON-BULK SUBSTATIONS

REDACTED

New Hampshire Design Violations Summary Report

Cutts Street 15W4

560 Maplewood Avenue, Portsmouth, NH

Cutts Street 15W4 is a 34.5-12.47 kV open-air non-bulk substation with a 4.5 MVA transformer and a single distribution feeder. The transformer has had fans applied post-manufacture.

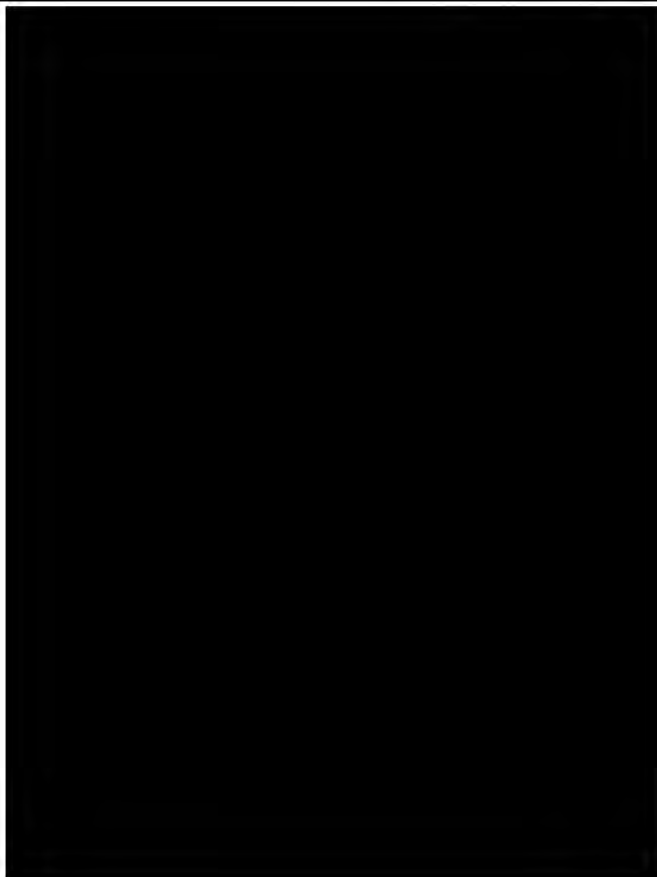

Loading and Capacity

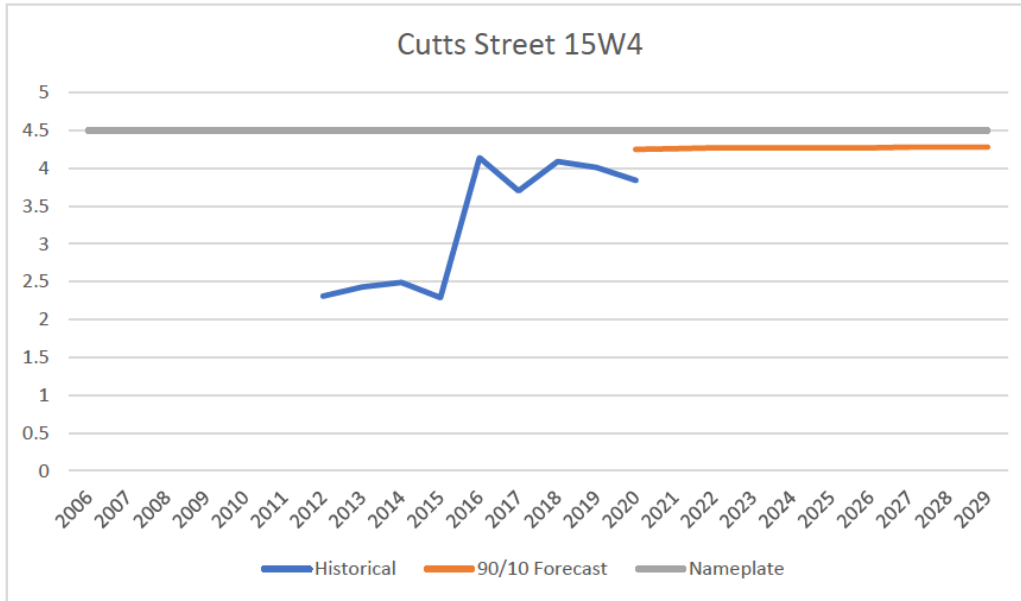

Distribution Company	Customers
Eversource Energy	815
Total Customers	815

	Mfg. Year	Condition Code ¹	Nameplate	LTE	STE
15W4	1956	2 – Yellow	4.5	5.9	6.7

Note 1: Transformer condition code as of May 2020.

Condition Assessment

The dissolved gases found in this oil are above average showing evidence of long-term thermal stressing of the paper insulation. The main tank has had multiple CO related gassing events in the last 20 years. Analysis of the oil indicates this is an unhealthy transformer due to the following factors:

- The main tank dissolved gas analysis has a history of thermal related gassing
- The main tank oil quality is poor showing to be contaminated and having low dielectric breakdown
- The main tank furans test reveals the degree of polymerization is low

System Planning Violations & Needs

	N-0 Base Load
First Year	10+
Deficit	None

Solution (for Mill Pond) – Transformer Replacement

In-Service Date: June 1, 2025

- Replace the 4.5 MVA 34.5-12.47 kV transformer at Cutts Street (non-bulk) Substation with a 12.5 MVA transformer.
- Enhance the 12.47 kV distribution system with D-SCADA and possible reconductoring/reconfiguration.

If a second transformer were to be added to Mill Pond, transmission work will be required to resolve the design violation of a Transmission N-1 producing greater than a Distribution N-1 at Mill Pond.

	Planning Study	Initial Funding	SDC Presentation	SDC Approval	EPAC Full Funding
Planned	Portsmouth 12kV 3/1/2021	3/1/2021	4/1/2022	5/1/2022	5/1/2023
Actual					

REDACTED

New Hampshire Design Violations Summary Report

Goffstown 27W2

41 Elm Street, Goffstown, NH

Goffstown 27W2 is a 34.5-12.47 kV switchgear non-bulk unit-substation with a 3.0 MVA transformer and a single distribution feeder. The transformer has had fans applied post-manufacture.

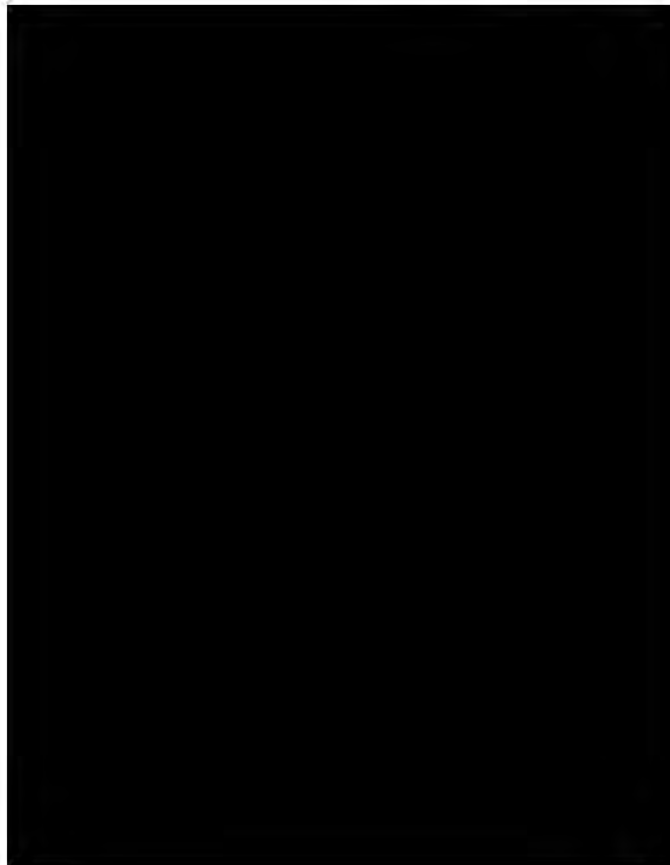
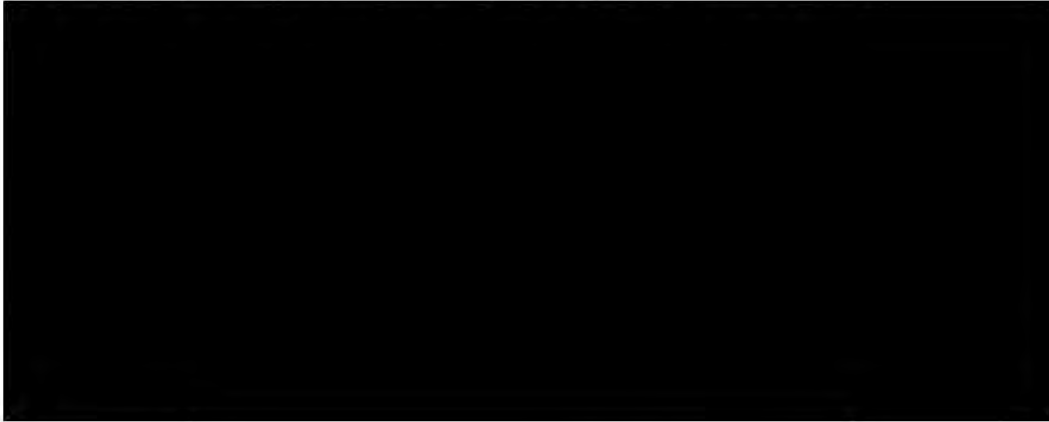

New Hampshire Design Violations Summary Report

Loading and Capacity

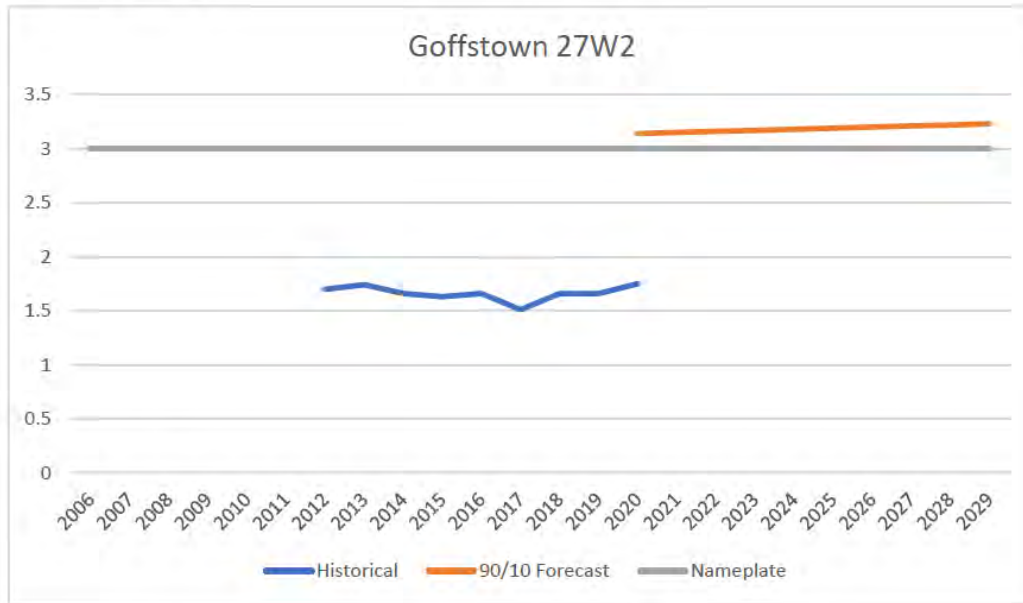

Distribution Company	Customers
Eversource Energy	772
Total Customers	772

	Mfg. Year	Condition Code ¹	Nameplate	LTE	STE
27W2	1956	2 – Yellow	3.0	3.9	4.5

Note 1: Transformer condition code as of May 2020.

System Planning Violations & Needs

	N-0 Base Load
First Year	2020
Deficit	0.1 MW

Solution – Line Conversion

In-Service Date: December 31, 2022

Distribution Engineering is responsible for this project.

- Distribution line conversion of the 4.16 and 12.47 kV distribution system in Goffstown to 34.5 kV.
- Retire Goffstown 27W2 and 45H1 equipment and remove substation.

	Planning Study	Initial Funding	SDC Presentation	SDC Approval	EPAC Full Funding
Planned	Goffstown 12/31/2019	N/A	N/A	N/A	N/A
Actual	11/2019	N/A	N/A	N/A	N/A

REDACTED

New Hampshire Design Violations Summary Report

Goffstown 45H1

41 Elm Street, Goffstown, NH

Goffstown 45H1 is a 34.5-4.16 kV switchgear non-bulk unit-substation with a 1.8 MVA transformer and a single distribution feeder. The transformer has had fans applied post-manufacture.

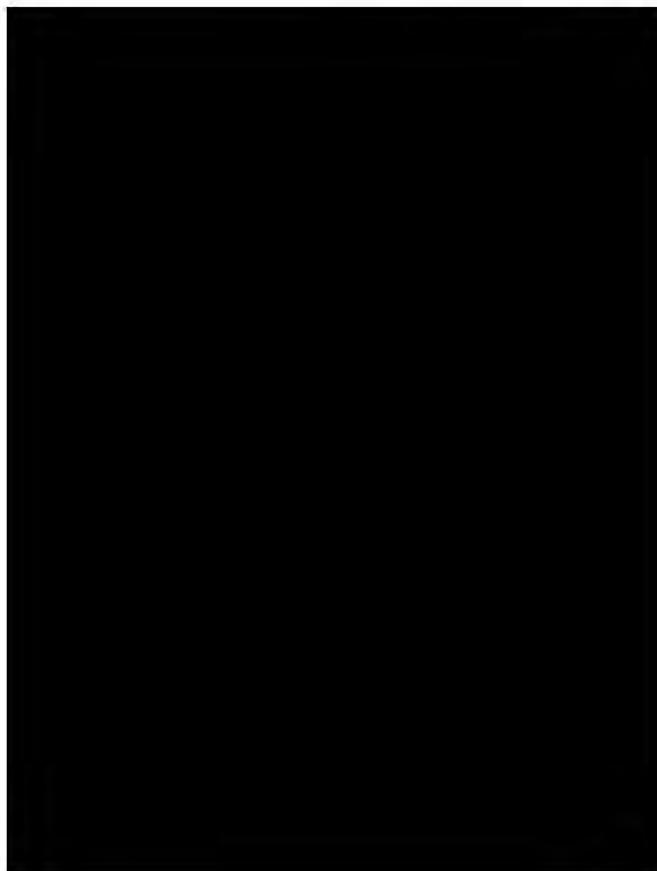
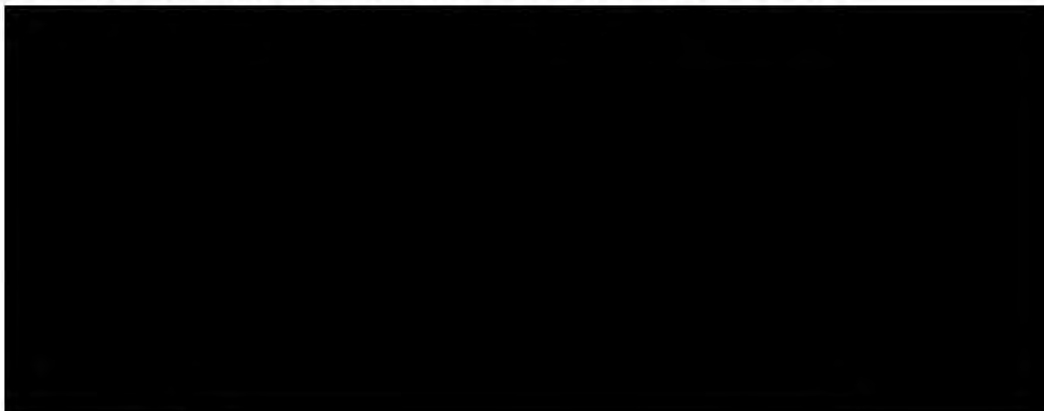

New Hampshire Design Violations Summary Report

Loading and Capacity

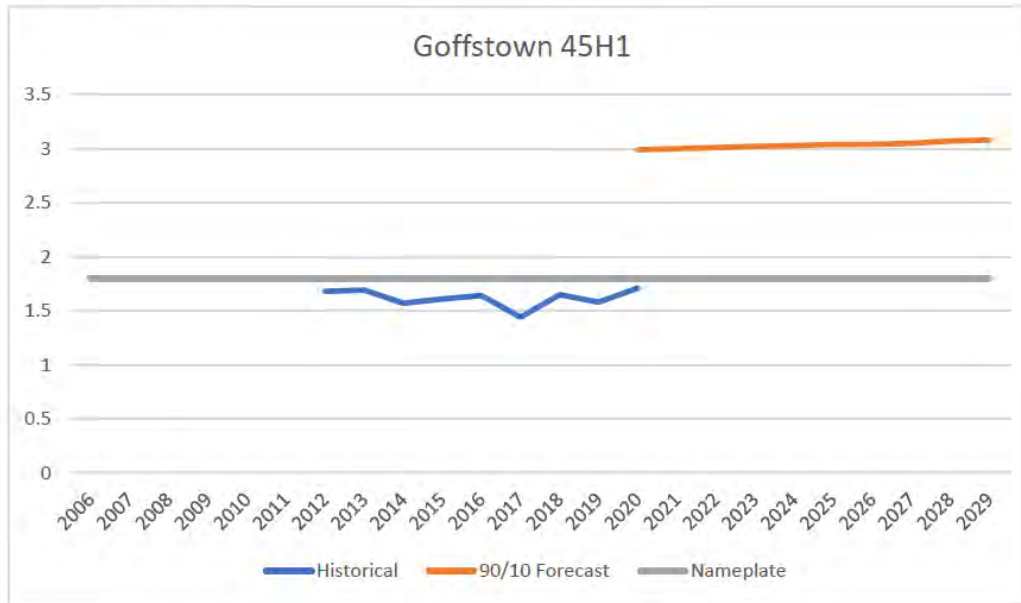

Distribution Company	Customers
Eversource Energy	704
Total Customers	704

	Mfg. Year	Condition Code ¹	Nameplate	LTE	STE
45H1	1955	3 – Orange	1.8	2.3	2.7

Note 1: Transformer condition code as of May 2020.

System Planning Violations & Needs

	N-0 Base Load
First Year	2020
Deficit	1.2 MW

Solution – Line Conversion

In-Service Date: December 31, 2022

Distribution Engineering is responsible for this project.

- Distribution line conversion of the 4.16 and 12.47 kV distribution system in Goffstown to 34.5 kV.
- Retire Goffstown 27W2 and 45H1 equipment and remove substation.

	Planning Study	Initial Funding	SDC Presentation	SDC Approval	EPAC Full Funding
Planned	Goffstown 12/31/2019	N/A	N/A	N/A	N/A
Actual	11/2019	N/A	N/A	N/A	N/A

REDACTED

Hanover Street 16W3

1081 Hanover Street, Manchester, NH

Hanover Street 16W3 is a 34.5-12.47 kV switchgear non-bulk unit-substation with a 3.36 MVA transformer and a single distribution feeder. The transformer has had fans applied post-manufacture.

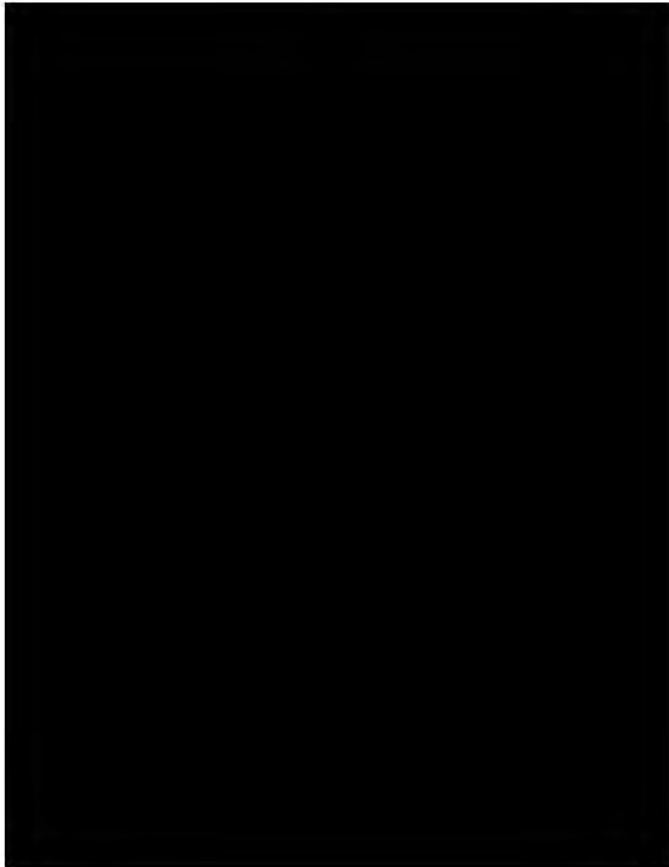
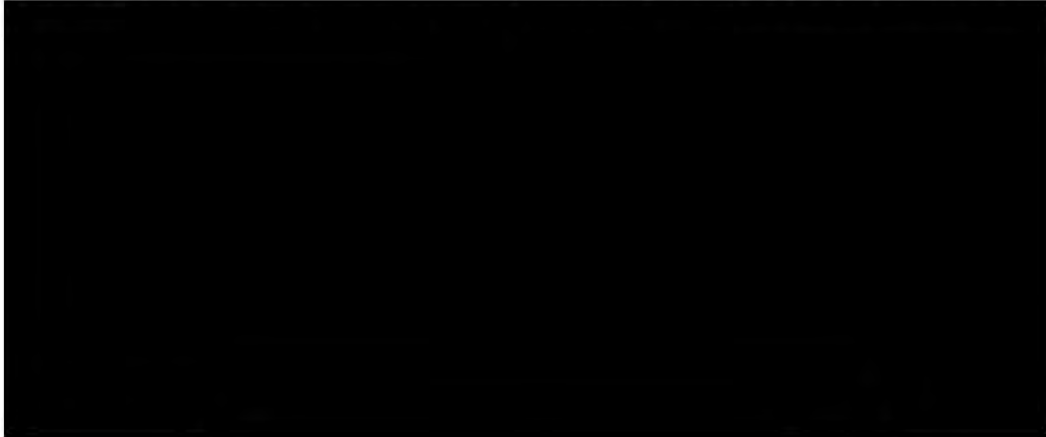

New Hampshire Design Violations Summary Report

Loading and Capacity

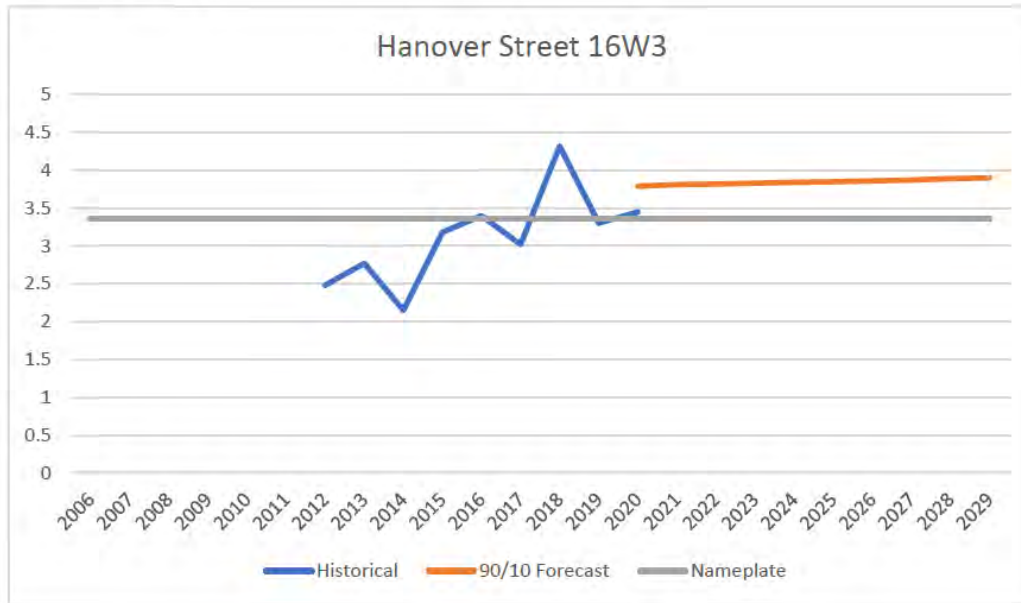

Distribution Company	Customers
Eversource Energy	1,212
Total Customers	1,212

	Mfg. Year	Condition Code ¹	Nameplate	LTE	STE
16W3	1962	2 – Yellow	3.36	3.8	4.4

Note 1: Transformer condition code as of May 2020.

New Hampshire Design Violations Summary Report

System Planning Violations & Needs

	N-0 Base Load
First Year	2020
Deficit	0.44 MW

Solution – Load Transfer

In-Service Date: December 31, 2021

Distribution Engineering is responsible for this project.

- Transfer Hanover Street 12.47 kV load to the 34.5 kV distribution system.

REDACTED

New Hampshire Design Violations Summary Report

Loudon 31W1

7010 Oak Hill Road, Loudon, NH

Loudon 31W1 is a 34.5-12.47 kV open-air non-bulk substation with a 5.25 MVA transformer and a single distribution feeder.

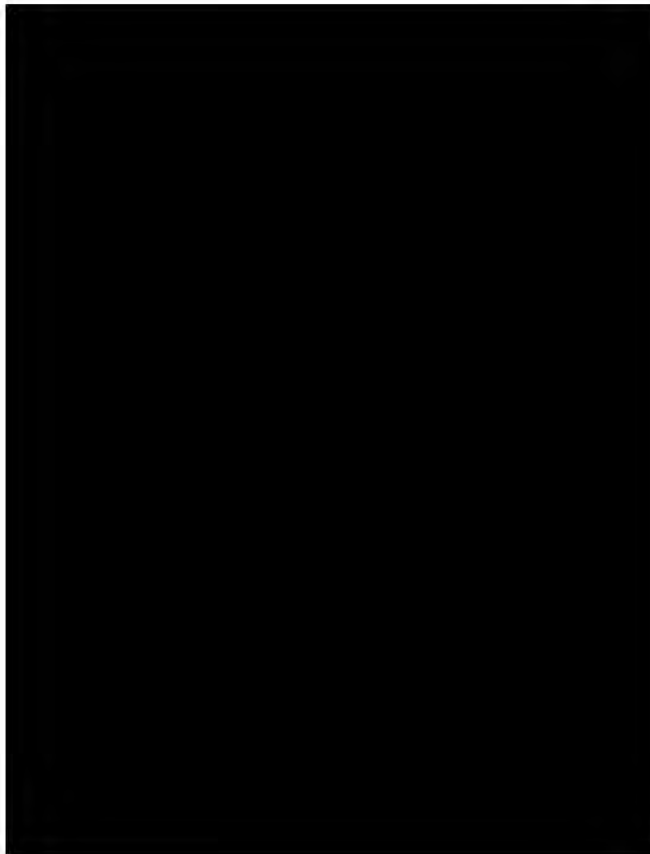

New Hampshire Design Violations Summary Report

Loading and Capacity

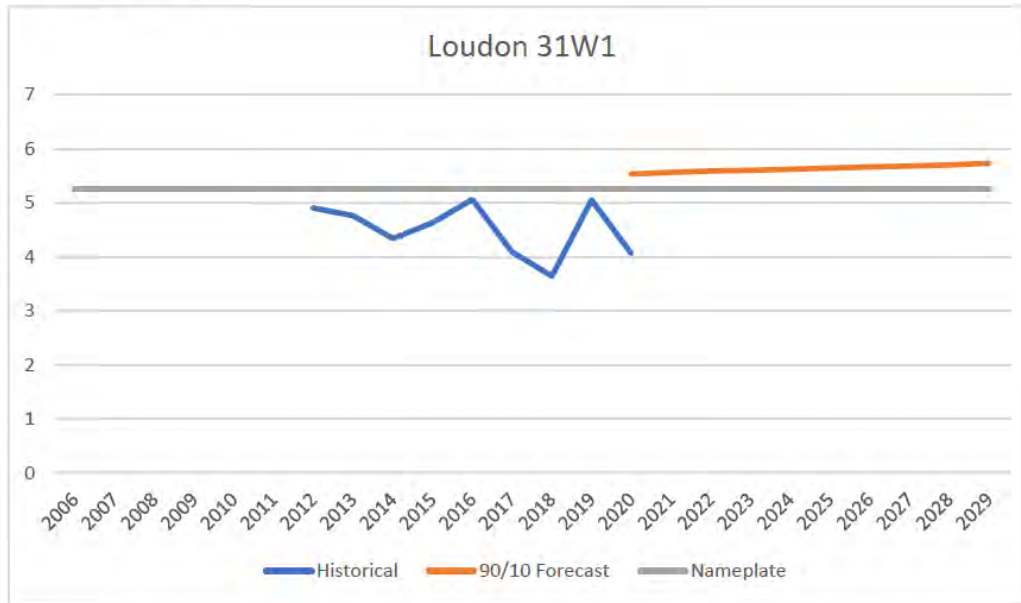

Distribution Company	Customers
Eversource Energy	1,412
Total Customers	1,412

	Mfg. Year	Condition Code ¹	Nameplate	LTE	STE
31W1	2006	1 – Green	5.25	6.3	7.1

Note 1: Transformer condition code as of May 2020.

System Planning Violations & Needs

	N-0 Base Load
First Year	2020
Deficit	0.28 MW

Solution – Transformer Replacement

In-Service Date: June 1, 2026

- Replace the existing transformers at Loudon Substation with a single 12.5 MVA unit to address base case loading design violation.

	Planning Study	Initial Funding	SDC Presentation	SDC Approval	EPAC Full Funding
Planned	Loudon 6/1/2021	3/1/2021	4/1/2023	5/1/2023	5/1/2024
Actual					

This project has been identified by the New Hampshire Public Utilities Commission and the Office of the Consumer Advocate as being a candidate to study in detail a non-wires solution to resolve base case loading.

REDACTED

New Hampshire Design Violations Summary Report

Loudon 31W2

7010 Oak Hill Road, Loudon, NH

Loudon 31W2 is a 34.5-12.47 kV open-air non-bulk substation with a 3.36 MVA transformer and a single distribution feeder. The transformer has had fans applied post-manufacture.

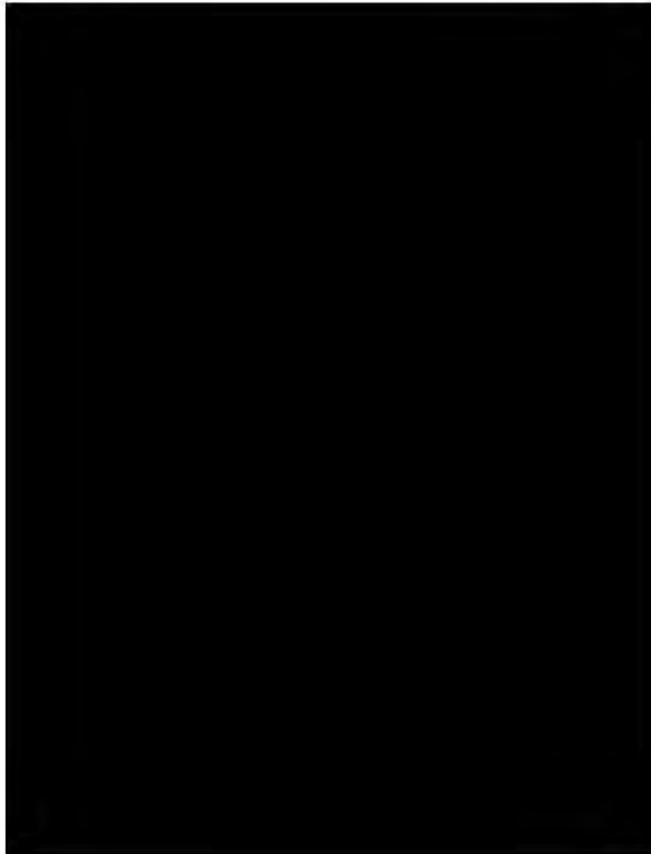
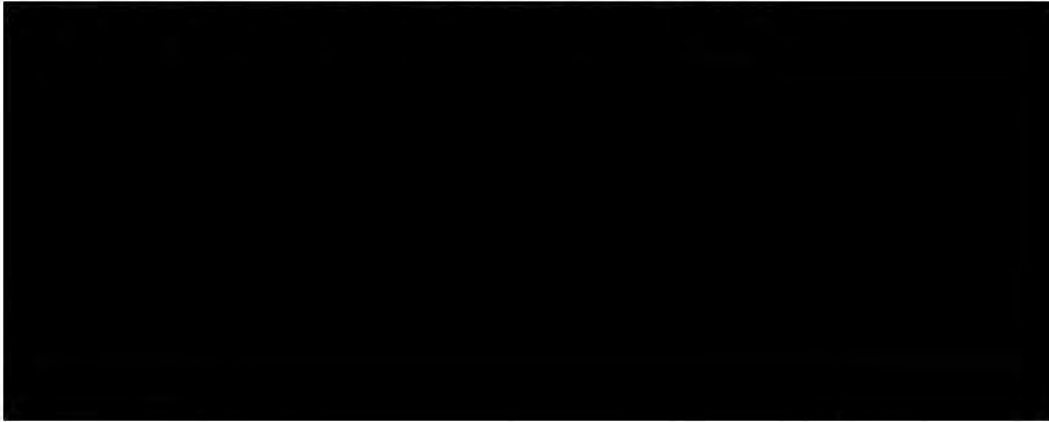

Loading and Capacity

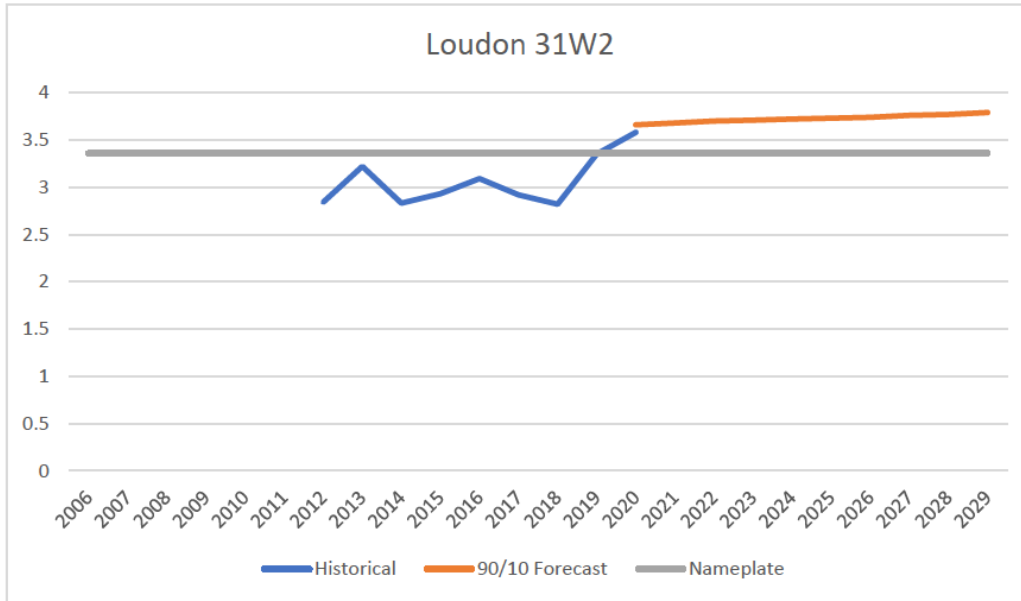

Distribution Company	Customers
Eversource Energy	1,247
Total Customers	1,247

	Mfg. Year	Condition Code ¹	Nameplate	LTE	STE
31W2	1964	2 – Yellow	3.36	3.8	4.4

Note 1: Transformer condition code as of May 2020.

Condition Assessment

Several of the dissolved gases found in this oil are high. Most recently showing evidence of thermal stressing of the paper insulation. There is also a history of electrical faults within the main tank. Analysis of the oil indicates this is an unhealthy transformer due to the following factors:

- The main tank dissolved gas analysis has a history of thermal related faults to paper insulation and electrical faults
- The main tank furans test reveals the degree of polymerization is very low with a high amount of 2-furfural
- X2 bushing needs replacement

System Planning Violations & Needs

	N-0 Base Load
First Year	2020
Deficit	0.34 MW

Solution – Transformer Replacement

In-Service Date: June 1, 2026

- Replace the existing transformers at Loudon Substation with a single 12.5 MVA unit to address base case loading design violation.

	Planning Study	Initial Funding	SDC Presentation	SDC Approval	EPAC Full Funding
Planned	Loudon 6/1/2021	3/1/2021	4/1/2023	5/1/2023	5/1/2024
Actual					

This project has been identified by the New Hampshire Public Utilities Commission and the Office of the Consumer Advocate as being a candidate to study in detail a non-wires solution to resolve base case loading.

REDACTED

Meetinghouse Road 3W2

160 Meetinghouse Road, Bedford, NH

Meetinghouse Road 3W2 is a 34.5-12.47 kV switchgear non-bulk unit-substation with a 5.04 MVA transformer and a single distribution feeder. The transformer has had fans applied post-manufacture.

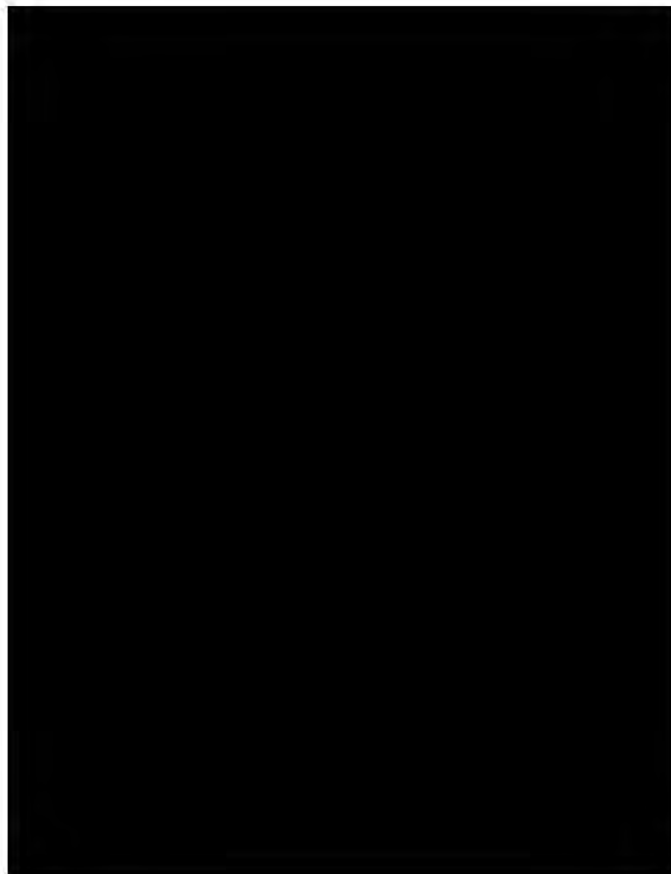
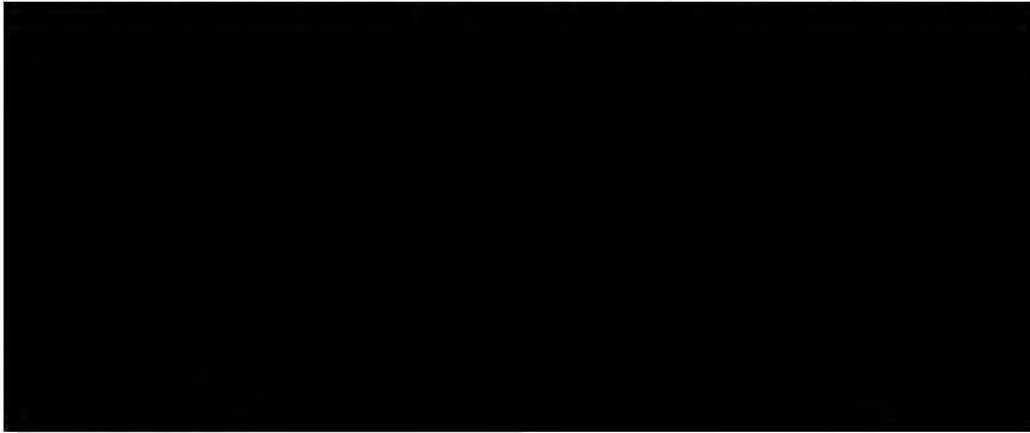

New Hampshire Design Violations Summary Report

Loading and Capacity

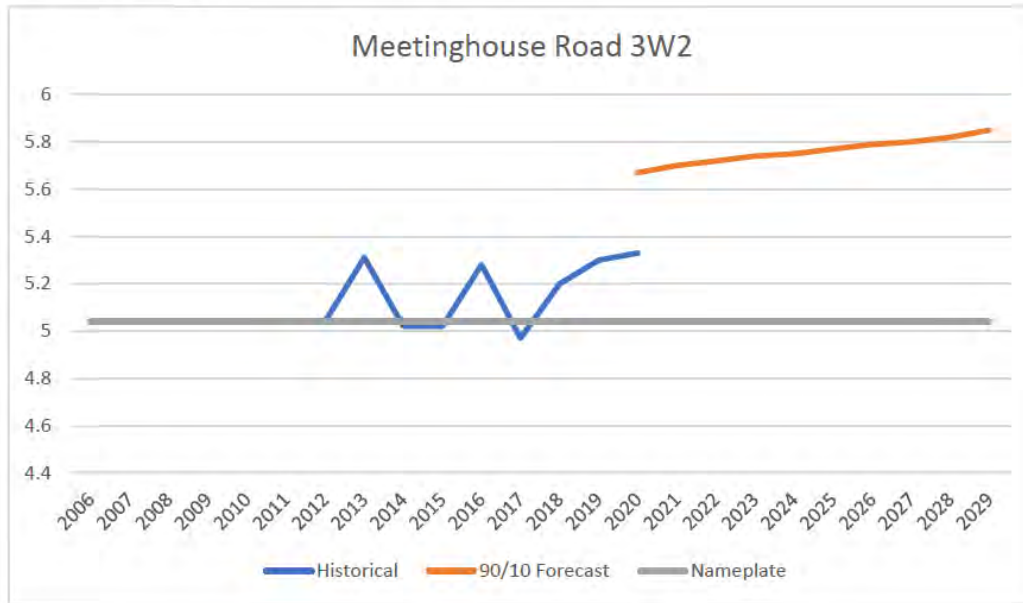

Distribution Company	Customers
Eversource Energy	1,266
Total Customers	1,266

	Mfg. Year	Condition Code ¹	Nameplate	LTE	STE
3W2	1969	1 – Green	5.04	5.8	6.6

Note 1: Transformer condition code as of May 2020.

New Hampshire Design Violations Summary Report

System Planning Violations & Needs

	N-0 Base Load
First Year	2020
Deficit	0.66 MW

Solution – Load Transfer

In-Service Date: December 31, 2021

Distribution Engineering is responsible for this project.

- Transfer Meetinghouse Road 12.47 kV load to the 34.5 kV distribution system.

REDACTED

New Hampshire Design Violations Summary Report

Opechee Bay TB10

1530 Parade Road, Laconia, NH

Opechee Bay TB10 is a 34.5-12.47 kV switchgear non-bulk unit-substation with a 2.5 MVA transformer and a single distribution feeder.

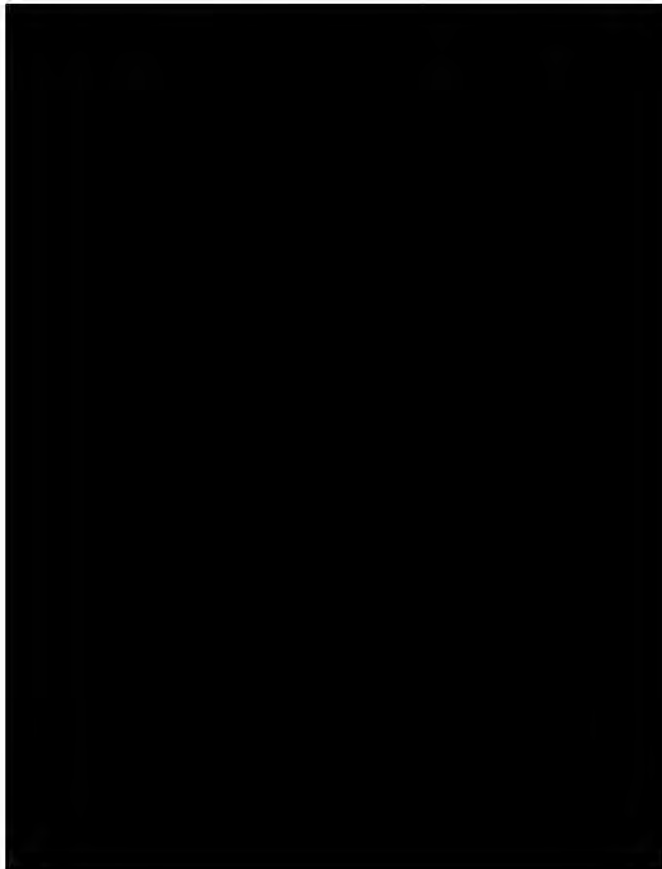

New Hampshire Design Violations Summary Report

Loading and Capacity

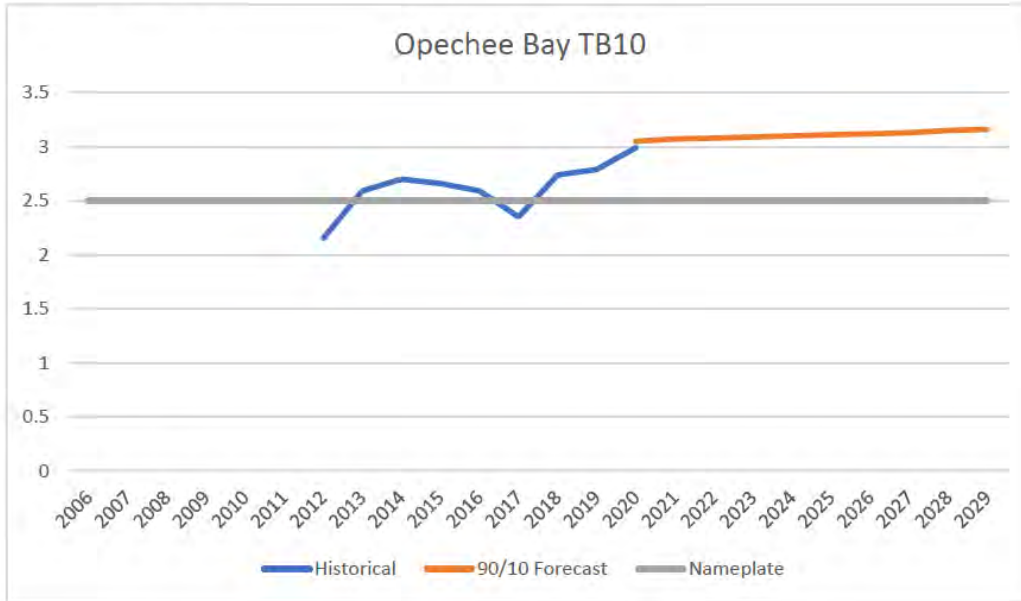

Distribution Company	Customers
Eversource Energy	1,116
Total Customers	1,116

	Mfg. Year	Condition Code ¹	Nameplate	LTE	STE
TB10	1956	2 – Yellow	2.5	3.8	3.8

Note 1: Transformer condition code as of May 2020.

*New Hampshire Design Violations Summary Report***System Planning Violations & Needs**

	N-0 Base Load
First Year	10+
Deficit	0.55 MW

Solution – Load Transfer

In-Service Date: June 1, 2021

Distribution Engineering is responsible for this project.

- Transfer Opechee Bay load to the Messer Street.

REDACTED

New Hampshire Design Violations Summary Report

Rye 48H1

490A Central Road, Rye, NH

Rye 48H1 is a 34.5-4.16 kV switchgear non-bulk unit-substation with a 3.75 MVA transformer and two distribution feeders.

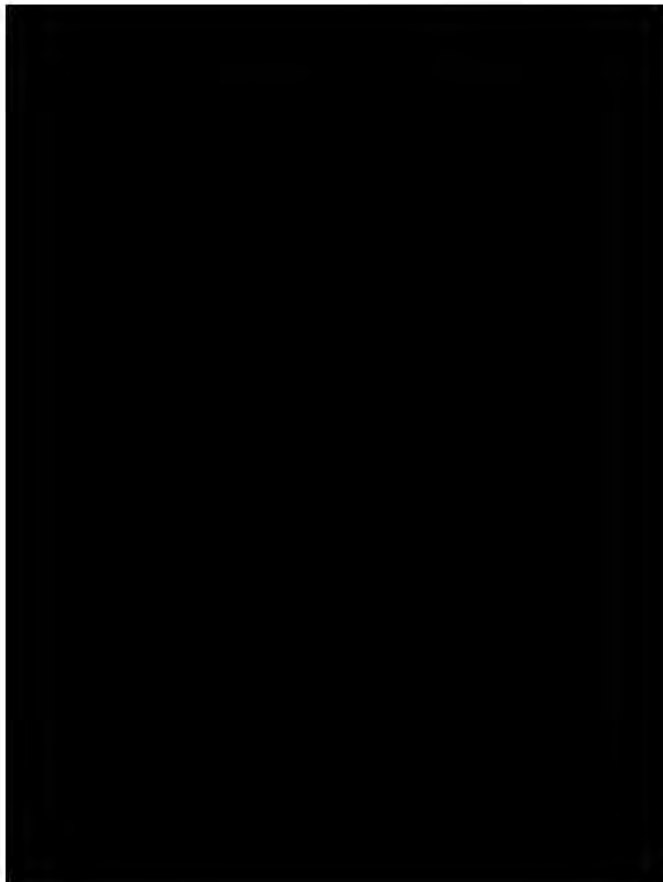
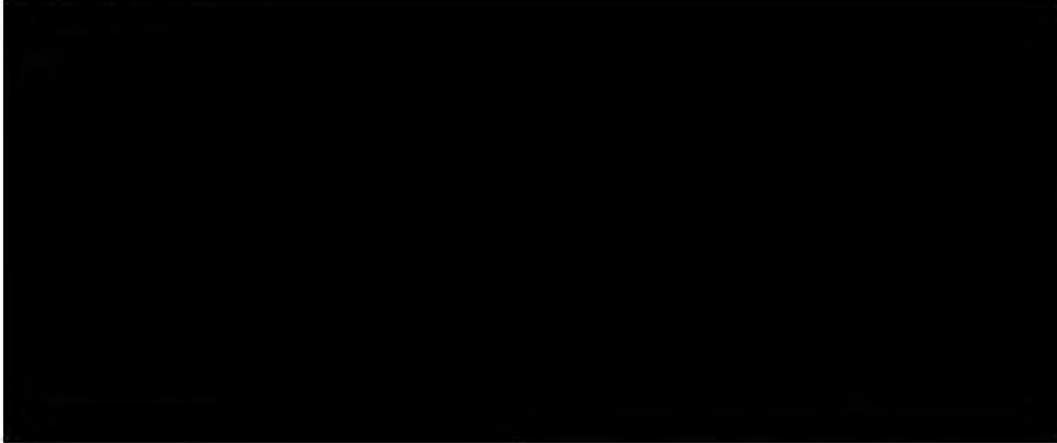

New Hampshire Design Violations Summary Report

Loading and Capacity

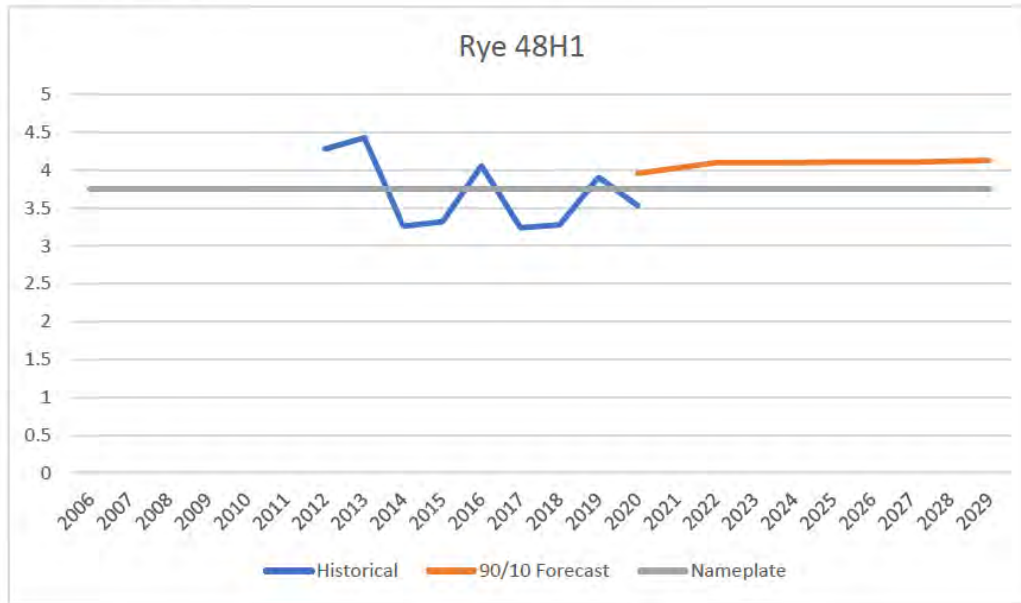

Distribution Company	Customers
Eversource Energy	1,031
Total Customers	1,031

	Mfg. Year	Condition Code ¹	Nameplate	LTE	STE
15W4	1956	2 – Yellow	3.75	4.8	5.6

Note 1: Transformer condition code as of May 2020.

New Hampshire Design Violations Summary Report

System Planning Violations & Needs

	N-0 Base Load
First Year	2020
Deficit	0.21 MW

Solution – Load Transfer

In-Service Date: June 1, 2022

Distribution Engineering is responsible for this project.

- Transfer Opechee Bay load to the Messer Street.

REDACTED

New Hampshire Design Violations Summary Report

Salmon Falls 51H1

530 Foundry Street, Rollinsford, NH

Salmon Falls 51H1 is a 13.8-4.16 kV open-air non-bulk substation with 1.5 MVA capacity of step transformers and a single distribution feeder.

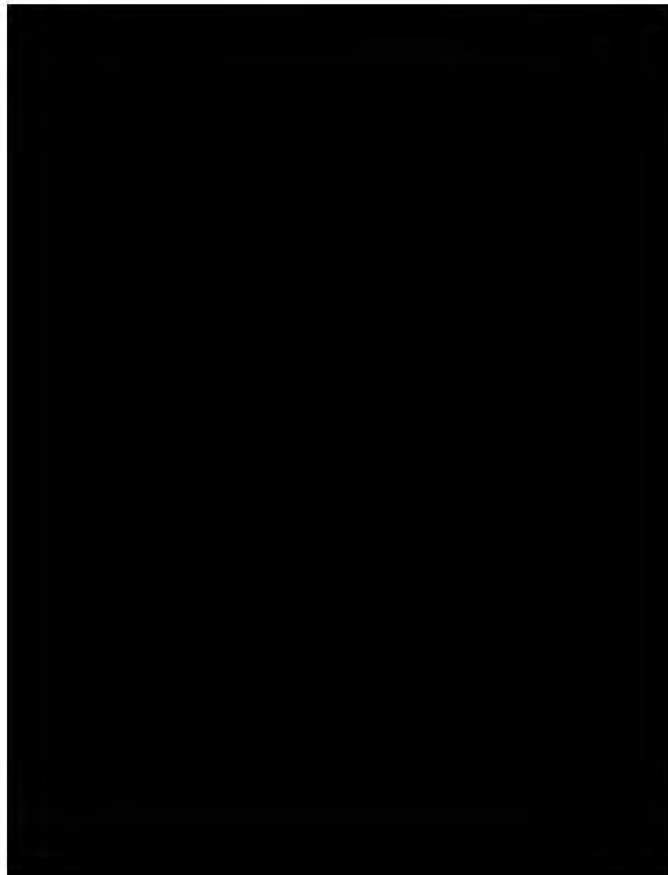

New Hampshire Design Violations Summary Report

Loading and Capacity

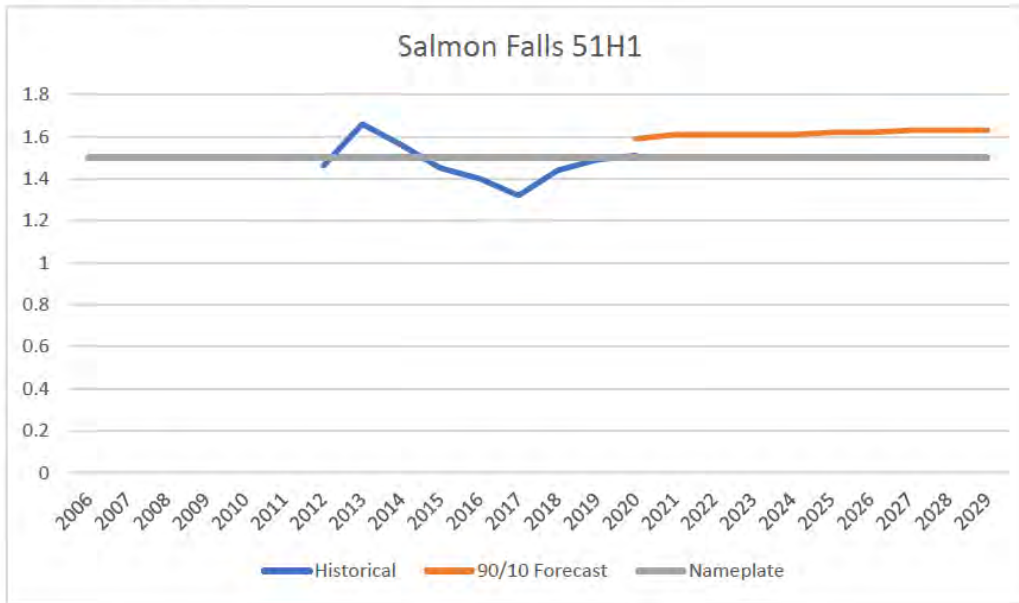

Distribution Company	Customers
Eversource Energy	651
Total Customers	651

	Mfg. Year	Condition Code	Nameplate	LTE	STE
51H1	1996	N/A	1.5	1.8	N/A

System Planning Violations & Needs

	N-0 Base Load
First Year	2020
Deficit	0.09 MW

Solution – Step Transformer Addition

In-Service Date: June 1, 2024

- Parallel the step transformers within Salmon Falls to double nameplate capacity.

	Planning Study	Initial Funding	SDC Presentation	SDC Approval	EPAC Full Funding
Planned	Salmon Falls 5/1/2021	3/1/2021	4/1/2022	5/1/2022	5/1/2023
Actual					

REDACTED

New Hampshire Design Violations Summary Report

Suncook 44W2

28 Canal Street, Allenstown, NH

Suncook 44W2 is a 34.5-12.47 kV switchgear non-bulk unit-substation with a 5.04 MVA transformer and a single distribution feeder. The transformer has had fans applied post-manufacture.

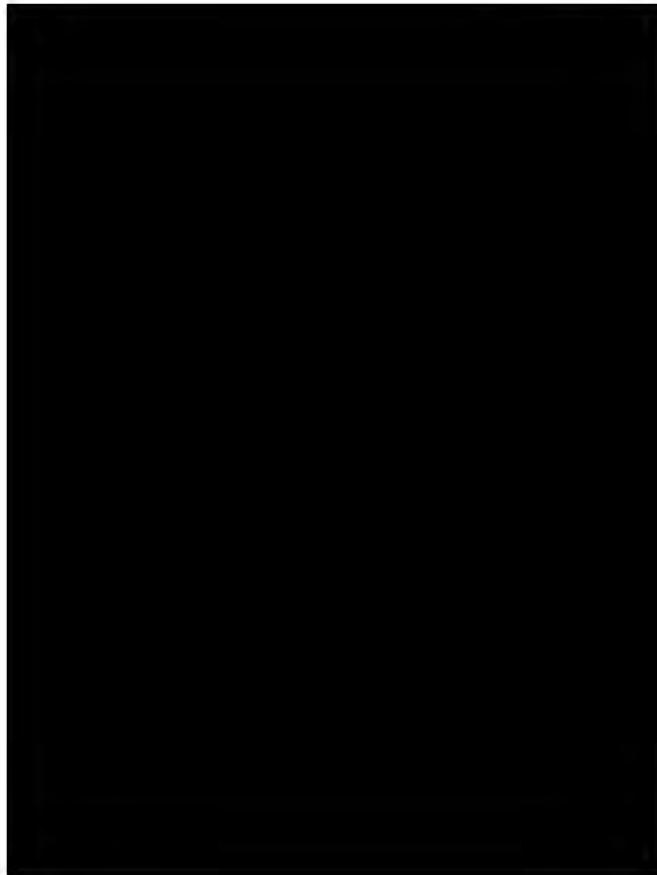

New Hampshire Design Violations Summary Report

Loading and Capacity

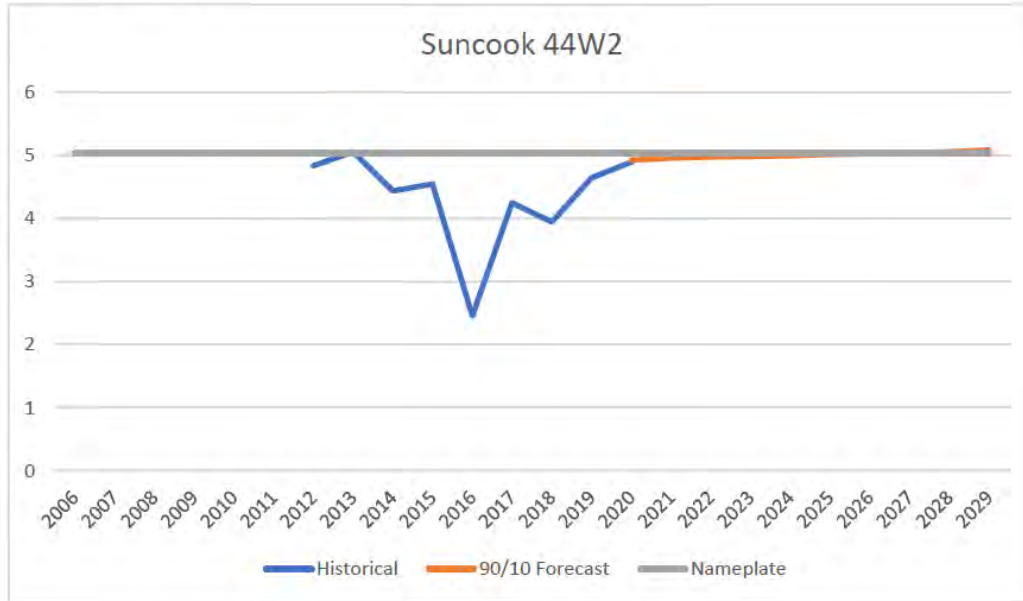

Distribution Company	Customers
Eversource Energy	2,342
Total Customers	2,342

	Mfg. Year	Condition Code ¹	Nameplate	LTE	STE
44W2	1965	2 – Yellow	5.04	5.8	6.6

Note 1: Transformer condition code as of May 2020.

New Hampshire Design Violations Summary Report

System Planning Violations & Needs

	N-0 Base Load
First Year	2027
Deficit	0.01 MW

Solution – Load Transfer

In-Service Date: June 1, 2027

- Transfer Suncook 12.47 kV load to the 34.5 kV distribution system.

REDACTED

New Hampshire Design Violations Summary Report

Weirs

135 Endicott Street, Laconia, NH

Weirs, formerly the location of a 34.5-4.16 kV unit-substation, is currently an RTU location in Laconia with a set of 34.5 kV regulators, SCADA-controlled switch, and a set of 34.5-12.47 kV pole-top step transformers. Land has been purchased nearby for the eventual construction of a new 34.5-12.47 kV substation.

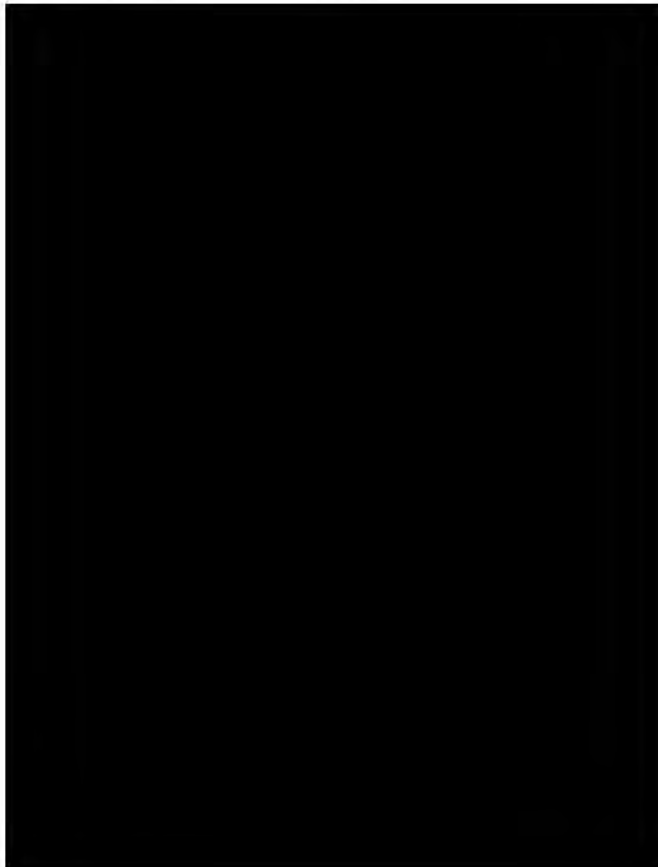
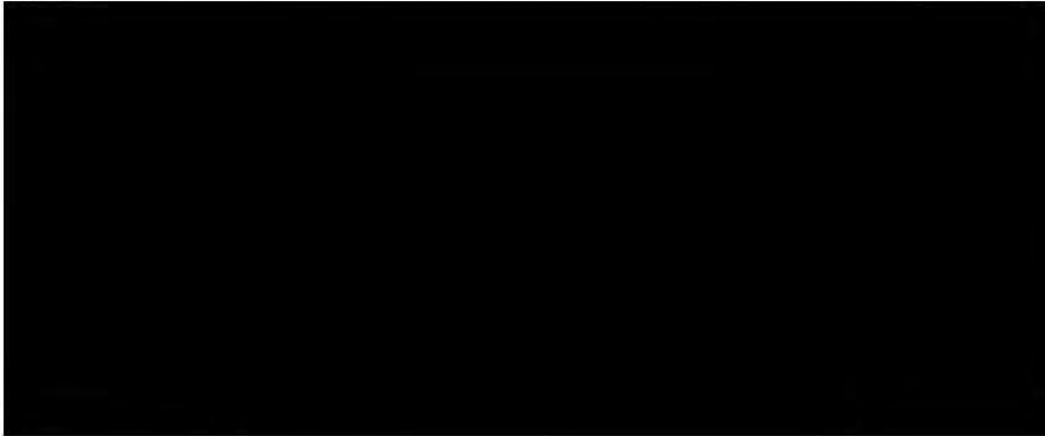

Appendix A: Determining Solution Milestones

When developing anticipated project milestones for solutions, the following guidance from Substation Design Engineering was utilized.

Timing as of February 10, 2021

<i>Milestone</i>	<i>Task Duration</i>
Intermediate Tasks	
Initial Funding Request	
Conceptual/Pre-Engineering	3 months
Estimating	3 months
SSF presented to SDC	
SDC Approval	1 month
Preliminary Engineering	6 months
30% Engineering Completion	
Detailed Engineering	6 months
Full Funding Request at EPAC	
	Immediate-1 month
Construction Start	
Construction	1-2 years
Project In-Service	

MONADNOCK

Analysis of the 115-34.5 kV Substation in Troy, NH

Matthew Cosgro

Senior Engineer, Distribution System Planning – New Hampshire

February 25, 2021

Monadnock Substation Study

This page intentionally left blank.

Contents

Figures and Tables	3
System Description, Design Violations and System Limitations	4
Overview	5
N-0, Base Case.....	7
N-1, Contingency.....	7
Substation	7
Distribution Feeder	8
Solution Needs and Options	8
Preferred and Alternative Solutions	9

Figures and Tables

Figure 1. Transmission and distribution map of the area in southwestern New Hampshire (2015).....	4
Figure 2. Substation One-Line of Monadnock Substation	6
Figure 3. Monadnock capacity and historical and forecasted load	7
Table 1. Monadnock transformer details, ratings in MVA.....	5
Table 2. Monadnock distribution circuit breakers	5
Table 3. Customers and load supplied by Monadnock	5
Table 4. Risk to customer load supplied by Monadnock	8

REDACTED

Monadnock Substation Study

System Description, Design Violations and System Limitations

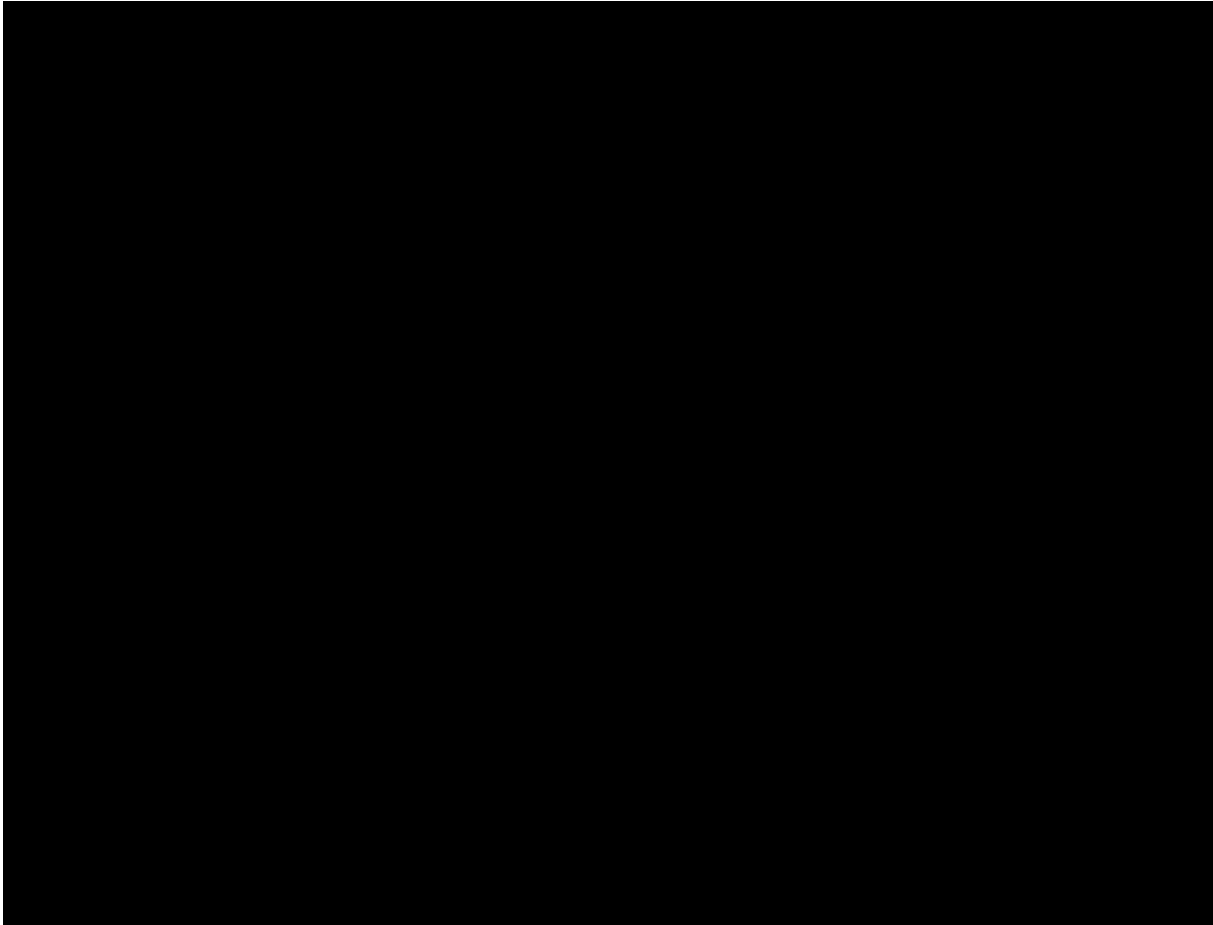

Figure 1. Transmission and distribution map of the area in southwestern New Hampshire (2015)

Green = 345 kV, Black = 115 kV, and Red = 34.5 kV

Overview

Monadnock Substation is a two-transformer 115-34.5 kV bulk substation located in Troy, New Hampshire. The station is supplied by three transmission lines; the Q166 from Fitzwilliam, the T198 from Emerald Street, and National Grid’s three-terminal I135N. The bus tie between the two distribution bus sections is operated normally open.

	Mfg. Year	Condition Code ¹	Nameplate	LTE	STE	LCC
TB40	1951	3 – Orange	20.0	28	30	
TB80	1965	1 – Green	28.0	34	38	
Substation			48.0		30	34.8

Note 1: Transformer condition code as of May 2020.

Table 1. Monadnock transformer details, ratings in MVA

The distribution system supplied by Monadnock consists of three feeders that serve customers in and around Troy and Rindge (3120 line), but also in an eastern/northeastern direction towards Jaffrey and Peterborough (382 and 3235 lines).

Of the four distribution circuit breakers at Monadnock, two are oil circuit breakers.

Position	Type	Manufacturer	Date
3235	Oil Circuit Breaker	General Electric	1953
BT20	Oil Circuit Breaker	General Electric	1956
3120	Vacuum Breaker	Siemens	2008
382	Vacuum Breaker	Siemens	2012

Table 2. Monadnock distribution circuit breakers

Monadnock Substation does not have low-side transformer breakers for either TB40 or TB80. As a result of this configuration, the entire station (including the 115 kV bus) experiences an outage for any transformer or distribution bus fault. Once the transformer high-side motor operated air-break switch is opened, dispatchers can then restore the 115 kV supply to the station via SCADA control and thus restoring the unaffected distribution load. Customers served from the feeders supplied by the faulted bus or transformer can be restored with the use of distribution circuit ties as system capacity allows.

	Customers Served	2020 Peak (MW)	2021 Forecast (MW)	2029 Forecast (MW)
Total Substation Load	12,923	34.8	37.8	39.3

Table 3. Customers and load supplied by Monadnock

REDACTED

Monadnock Substation Study

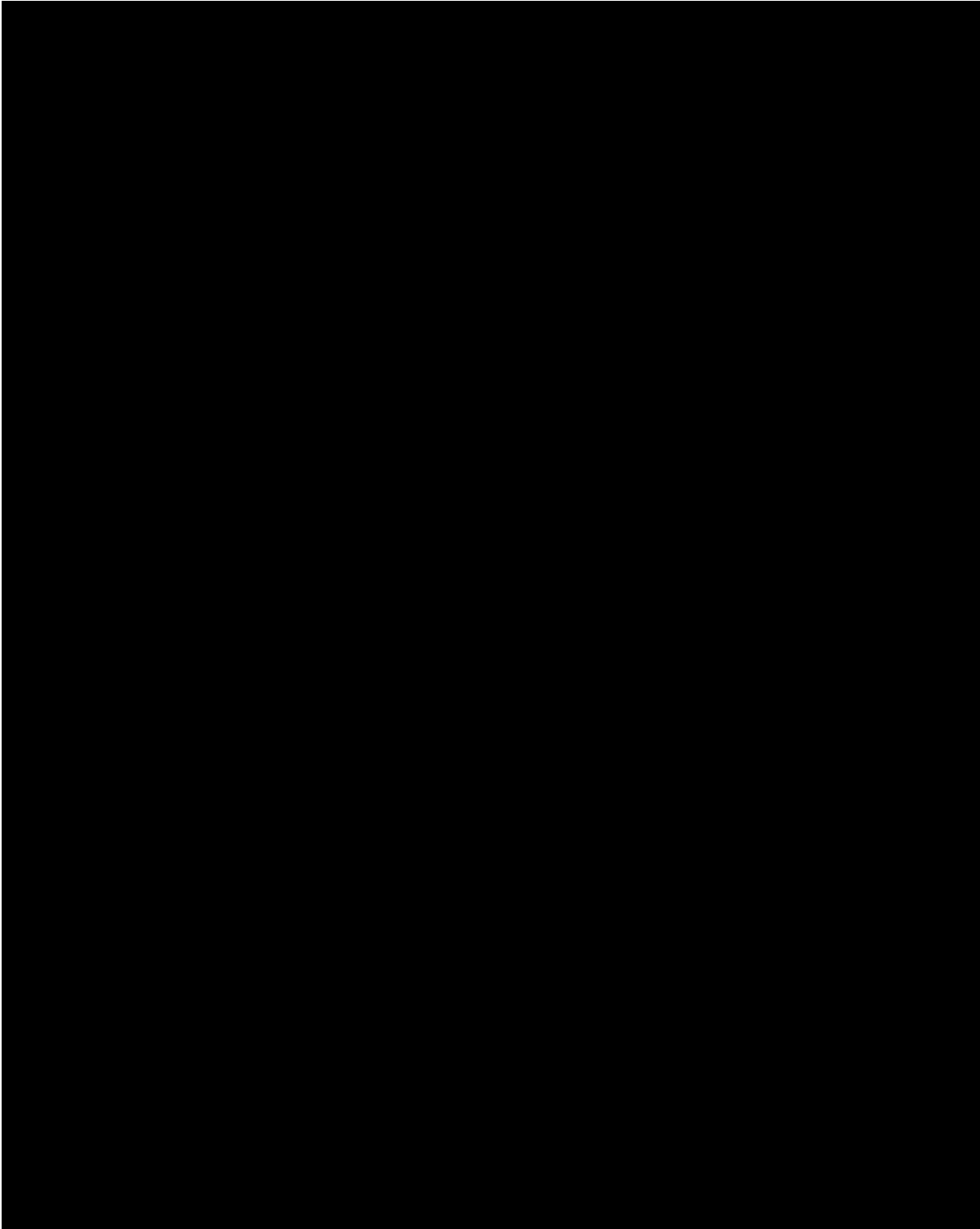

Figure 2. Substation One-Line of Monadnock Substation

Monadnock Substation Study

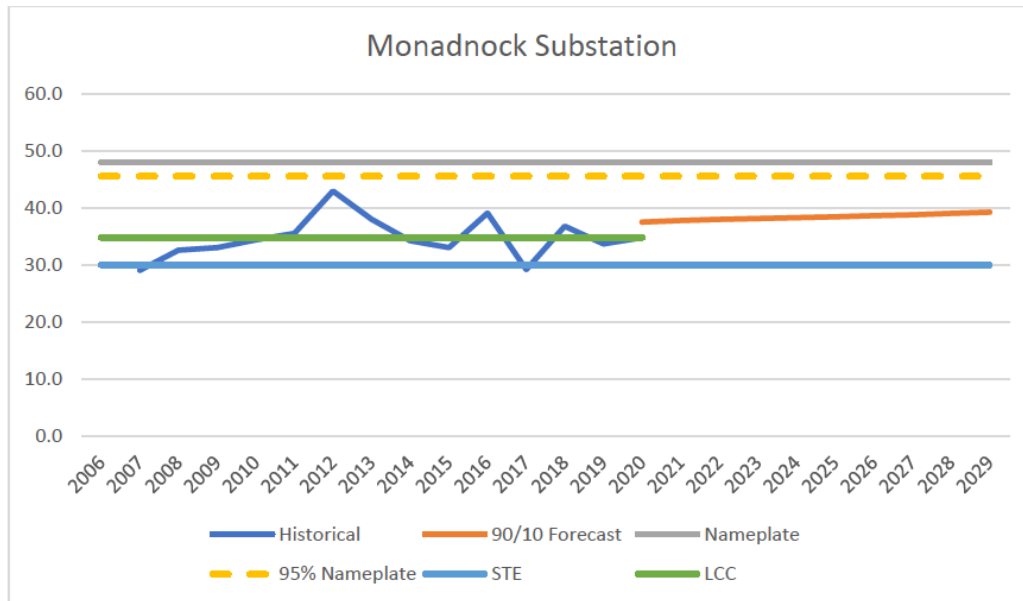

Figure 3. Monadnock capacity and historical and forecasted load

N-0, Base Case

Per the Distribution System Planning Guide, bulk substation transformers that provide back-up supply to other stations shall be loaded to no more than 95% of their nameplate rating, where the 95% pre-load is utilized in the development of emergency ratings of transformers. It should be noted that operating the transformer to 100% nameplate is not restricted with this criterion.

The Distribution System Planning Guide indicates that any feeder whose load has reached 90% of its Normal capacity should be identified and a resolution for loading planned. Loading on the feeder shall not exceed 100% of its Normal ratings.

Historical and forecasted load levels for the substation are within the Distribution System Planning Guide design criteria for both the transformers and lines.

N-1, Contingency

Substation

The Distribution System Planning Guide directs that the Eversource distribution system shall be designed to sustain any loss of a bulk substation bus section, bus tie breaker, or transformer with no sustained load loss. Restoration switching upon a contingency event is limited to three load block transfers, one of which may be a cascading step. A cascading step is one that increases capacity at a substation utilized for restoration. Eversource calculates a Load Carrying Capacity (LCC) for bulk substations that identifies the restoration capacity during an N-1 transformer event. Substation load cannot exceed the LCC.

Monadnock Substation Study

Element	Type	Customers Affected ¹	Load Affected ² (MW)	LCC ³ (MW)	Load Block Transfers	Sustained Load Loss (MW)	Customers Adversely Impacted
TB40	115-34.5 kV Transformer	12,923	37.8	34.9	3	0	0
TB80	115-34.5 kV Transformer	12,923	37.8		1	5.6	448
Bus 1	Distribution Bus	12,923	37.8	n/a	3	0	0
Bus 2	Distribution Bus	12,923	37.8	n/a	1	5.6	448
BT20	Bus Tie Breaker	12,923	37.8	n/a	1	31.8	9,281

Note 1: Customer counts as of February 25, 2021.

Note 2: Loading data is derived from the 2021 Monadnock Substation 90/10 forecast.

Note 3: Substation LCC is based on the capacity of the smallest transformer and circuit ties.

Table 4. Risk to customer load supplied by Monadnock

For two-transformer substations, the station load should not exceed the smallest transformer short-term emergency (STE, 30 minute) rating. This allows for traditionally-designed substations to experience loss of a transformer and still provide continuity of service to customers. Distribution system reconfigurations can then reduce loading, if necessary, to get loading within the long-term emergency (LTE, seasonal 12 or 4 hours) rating. Although the present protection schemes in place at Monadnock prevent the possibility of load automatically exceeding that of the single transformer, it is recognized that peak station load exceeds the STE rating of the smallest transformer.

Distribution Feeder

34.5 kV Distribution feeder contingencies are covered by Eversource New Hampshire's ED-3002 Distribution System Planning and Design Criteria Guidelines, which relies on a mobile substation solution allowing for 30 MW of isolated load following three load blocks of restoration switching. The company's intention is to migrate towards a 0 MW threshold for non-radial feeders at a bulk substation.

With existing conditions and forecasted load levels, there are no design violations with existing criteria or proposed.

Solution Needs and Options

The above planning criteria is intended to maintain safe, reliable operation of the distribution system. Based on the noted design violations, solution options to bring Monadnock Substation into compliance with Eversource's criteria must address the following:

- Reduce load or increase system capacity to address LCC deficit.
- Reduce load or increase transformer capacity to address STE deficit.

Monadnock Substation Study

- Improve the substation design to address customer reliability for a transformer, bus, or bus tie breaker contingency.

The possible opportunities to address capacity deficits by reducing existing load include non-traditional solutions such as battery storage, solar, energy efficiency, demand response as well as increasing capacity with traditional solutions of additional transformation and increasing feeder capacity with reconductoring or new construction. Unfortunately, due to the combination of the immediate need, poor condition of transformer TB40 (Long Term Health Index > 0.5), and overall substandard design issues impacting reliability, non-wires solutions will not be considered.

Preferred and Alternative Solutions

Ultimately there are two possible solutions to increase contingent capacity at Monadnock Substation: increase the size of the transformers or construct a new substation. Unfortunately, the ideal placement of a new substation would be in the Jaffrey-Peterborough area, which would require a new transmission line and potential transmission facility upgrades to stations affected by the new line. Construction of this new substation would reduce loading on Monadnock, but does not address the poor condition of transformer TB40 or the substandard design of Monadnock (lack of low-side transformer breakers).

Therefore, the preferred solution for addressing transformer condition, customer reliability, and substandard design is equipment replacement and additions to Monadnock.

Preferred Solution – Monadnock Substation Upgrades

- Replace the existing 20 and 28 MVA transformer with two Eversource-standard transformers
- Install two transformer circuit breakers
- Install a series bus tie breaker with bus tie BT20

WHITE LAKE

Analysis of the 115-34.5 kV Substation in Tamworth

Yassine Mhandi

Engineer, Distribution System Planning – New Hampshire

February 2021

White Lake Substation Study

This page intentionally left blank.

White Lake Substation Study

Contents

Figures and Tables	3
Executive Summary.....	4
Introduction	5
White Lake Contingency Analysis	6
Distribution	6
Transmission	6
Proposed Solution Option.....	7
Distribution	7
Transmission	7
Appendix A: Existing White Lake Area One Line	8

White Lake Substation Study

Figures and Tables

Figure 1: Modification for White Lake Substation Design	7
Table 1: N-1 transformer and feeder contingencies.....	6

Executive Summary

The NH 2021 load forecast for the White Lake transformers (TB76 & TB82) is 92% of the nameplate rating; however, due load sharing characteristics between these two transformers, this puts TB82 at 95% nameplate rating. During July 2018, the White Lake TB82 transformer was loaded up to 95% of the nameplate rating, which was significantly higher than the forecast. The peak load exceeds the short-term emergency (STE) rating of the remaining transformer for the contingent loss of one transformer, and peak load forecast is projected to exceed 95% loading in 2022, violating Eversource's Distribution Planning Guide.

Additionally, the area served by White Lake substation faces contingency issues such as feeder failures and limited load carrying capacity for supporting remote substations.

Moreover, White Lake transformers, electromechanical relays and oil circuit breakers (OCB) are aging, and much of this equipment is targeted to be replaced.

This study recommends the following:

- Replace the existing 115-34.5 kV 28 MVA White Lake substation transformers with 62.5 MVA rated transformers
- Replace distribution equipment with double-bus switchgear
- Upgrade associated substation protective relaying.
- Rearrange feeder position to balance the load on the transformers
- Allocate a feeder position to White Lake Combustion Turbine
- Upgrade the existing 115 kV bus and equipment to a ring bus.

Engineering phase has been initiated to address OCBs, aging equipment and issues related to divestiture, which would include the recommendations mentioned above.

Introduction

White Lake substation consists of two 28 MVA transformers (1963, 1964). Loss of one of these transformers isolates 14.5 MW of load (Wolfeboro Municipal). Significant work is planned at White Lake to address issues associated with the divestiture of the combustion turbine as well as oil circuit breakers and aging equipment.

The NH 2022 load forecast for the two 115-34.5 kV, 28 MVA White Lake transformers (TB76 & TB82) is projected at 51.6 MVA or 92% of its nameplate rating. During 2018 heat wave, the actual loading on the White Lake transformers was 50.8 MW or 91% of its nameplate rating. The recent peak was 47.6 MW in 2020. The peak load exceeds the short-term emergency (STE) rating of a single transformer at White Lake substation. The loading is projected to exceed the limit of 95% of the nameplate rating which violates Eversource's Distribution System Planning Guide.

A condition assessment was performed on the existing 34.5 kV equipment to determine if any equipment should be replaced based upon its condition. A list of equipment to be addressed is as follows:

- Transformers – the transformers at White Lake are beyond their useful life.
 - TB76 transformer is 58 years old. Health assessment concerns are primarily with the Fluid Quality.
 - TB82 transformer is 57 years old. Health assessment concerns are primarily with the Dissolved Gas Analysis (DGA)
- Circuit Breakers – there has been a focus on removing OCBs from the Eversource system. These OCBs range from 54 to 70 years old, no longer have spare parts, and are difficult to maintain.
- Distribution Electromechanical Relays – White Lake feeder breakers and load-side transformer breakers are equipped with electromechanical relays. A program has been established to replace distribution electromechanical relays with solid state programmable relays, which would include the above-mentioned relays.

The 346 line terminal is to be fed from a separate bus other than the bus intended for 3116 breaker position. This would balance the load on the two transformers. Also, a breaker position will be dedicated to the White Lake Combustion Turbine.

Furthermore, from a transmission stand point, a 115-kV bus fault or breaker failure would result in loss of both transformers, isolating nearly all customers. This violates planning criteria in the Distribution System Planning Guide.

White Lake Contingency Analysis

Distribution

White Lake substation faces an STE violation where the load exceeds transformer STE rating by 12.7 MVA. With no possible switching to offload this station, this puts Wolfeboro Municipal at risk of isolation.

Additional contingency violations are listed in the table below which are based off 2021 forecasted loads. System Planning design criteria does not allow for any isolated load following a single transformer or bus fault contingency event. New Hampshire's ED-3002 Distribution System Planning and Design Criteria Guidelines allow for up to 30 MW to be affected, however the company will be migrating towards a 0 MW threshold. Feeder faults are identified here as part of the effort to identify locations at risk of the future criteria.

Contingency	Isolated Load (MW)	Notes
Loss of single transformer	14.5	Limited by the remaining White Lake XFMR which exceeds STE rating. Isolating Wolfeboro Municipal reduces the loading on the remaining transformer to under LTE rating.
34.5 kV Bus Fault	43.2	Limited by load carrying capability from Ashland 338 and Saco Valley 347 lines.
Loss of 3116X feeder	14.5	Limited by White Lake 346 line 7.95 Miles of 336 ACSR from White Lake to 346X1 tap. Isolating Wolfeboro Municipal reduces loading on the 336 ACSR conductor to under its emergency rating.
Loss of 346 feeder	5.6	Limited by White Lake 3116X line 6.78 Miles of 336 ACSR from White Lake to Center Ossipee. Isolating NHEC Tuftonboro reduces loading on the 336 ACSR conductor to under its emergency rating.

Table 1: N-1 transformer and feeder contingencies

Additionally, White Lake substation is also interconnected to Saco Valley substation; for loss of the Saco Valley transformer, the load cannot be fully restored.

Transmission

The 115-kV circuit breaker and bus at White Lake are prone to a 115-kV bus fault or a 115-kV circuit breaker failure, which would result in the loss of both transformers. This violates the system planning criteria that a single transmission contingency shall not cause something more than a single contingency at a distribution substation.

Proposed Solution Option

Distribution

For White Lake substation, it is recommended to:

- Replace the existing transformer with 62.5 MVA rated transformers.
- Replace the distribution equipment with a double-bus switchgear.

For distribution feeders, addressing the 346 and 3116X line contingencies can be accomplished by:

- Reconductoring 346 line 7.95 Miles of 336 ACSR from White Lake to 346X1 tap with 477 Spacer Cable.
- Reconductoring 3116X line 6.78 Miles of 336 ACSR from White Lake to Center Ossipee with 477 Spacer Cable.

Transmission

It is recommended to modify the existing transmission layout from a straight bus to a ring bus, which would allow for operational flexibility by removing only a single transformer during bus fault, a stuck breaker or planned outages. Figure 1 below shows the proposed modification for White Lake substation. New equipment is shown in red.

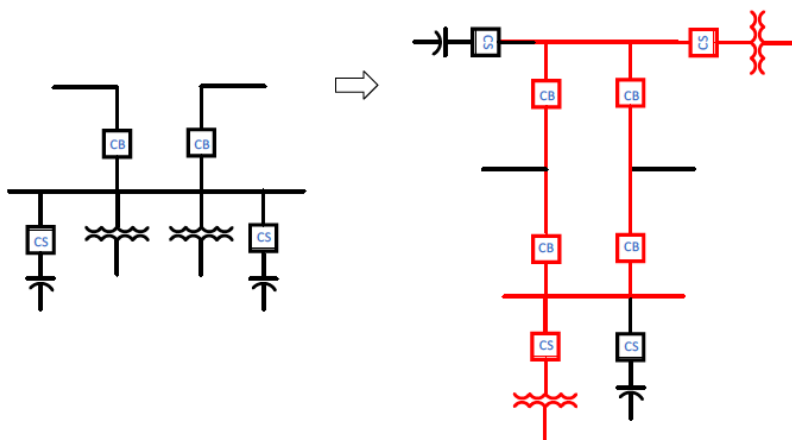
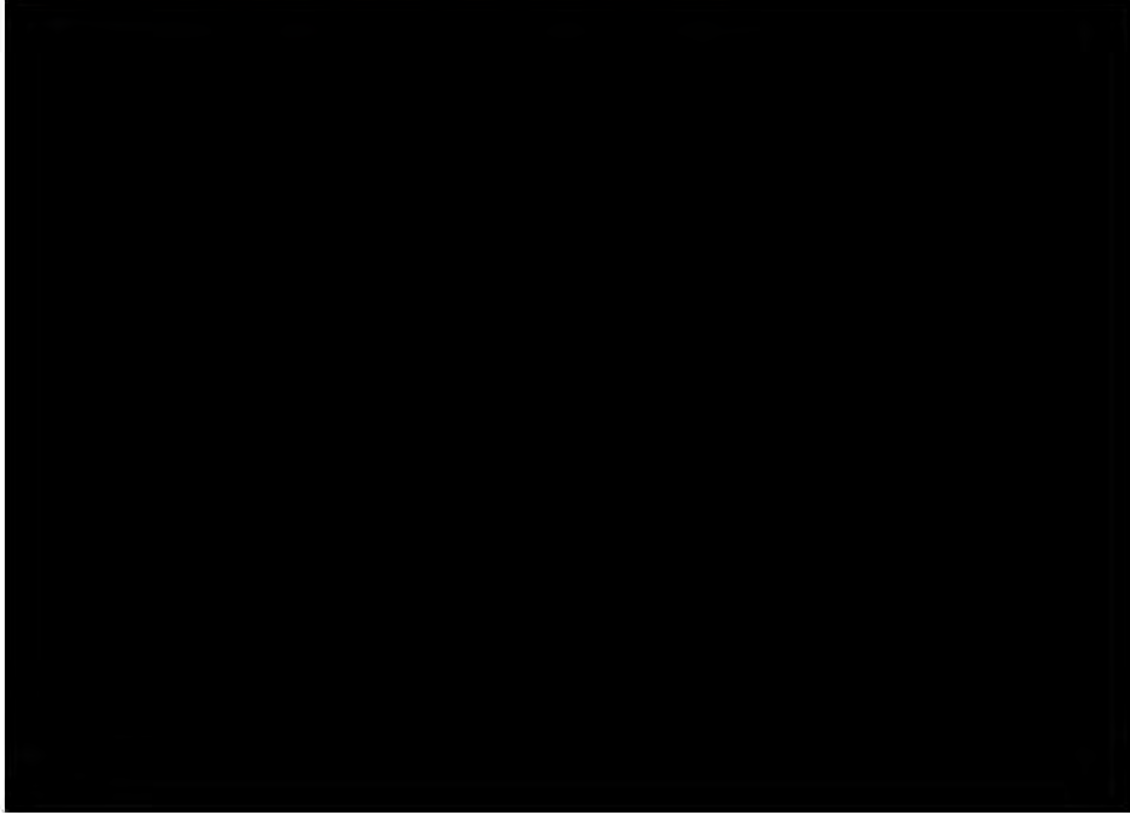

Figure 1: Modification for White Lake Substation Design

White Lake Substation Study

REDACTED

Appendix A: Existing White Lake Area One Line



SOUTH MILFORD

Analysis of the 115-34.5 kV Substation in Milford, NH

Cosgro, Matthew D

Senior Engineer, Distribution System Planning – New Hampshire

March 5, 2020

This report is in a draft state. As pre-engineering and estimates are completed, the scope and description of each solution option and the designation of preferred option will be re-evaluated.

South Milford Substation Study

This page intentionally left blank.

Contents

Figures and Tables	3
System Description, Design Violations and System Limitations	4
Overview	6
N-0, Base Case.....	9
Substation	9
Distribution Feeder	10
N-1, Contingency.....	11
Transmission	11
Substation	11
Distribution Feeder	11
Distributed Generation Limitation at Amherst Substation.....	12
Parallel Distribution Supply Lines: Amherst-South Milford.....	13
Solution Needs and Options	14
Base Case Capacity.....	14
Substation	14
Distribution Feeder	15
Contingent Capacity.....	15
Substation	15
Distribution Feeder	15
Transmission Contingency	16
Preferred and Alternative Solutions	16
Distribution	17
Transmission	22
Appendix A – Order of Magnitude Project Estimates.....	25
Appendix B – Decision Matrices	27

Figures and Tables

Figure 1. South Milford Substation viewed from Hammond Road, Milford.....	4
Figure 2. Overview of the Transmission and Distribution system in the Milford area.....	4
Figure 3. Milford area distribution system.....	5
Figure 4. Transmission one-line of the system supply to South Milford.....	7
Figure 5. Geographic map of the transmission system in the Nashua-Milford area.....	7
Figure 6. Substation One-Line of South Milford.....	8
Figure 7. Historical trend and forecast load levels for South Milford transformer TB86.....	10
Figure 8. Milford area distribution system showing Option D-1, new feeder in 398 right-of-way.....	19
Figure 9. Milford area distribution system showing Option D-2, new feeder in 314 right-of-way.....	20
Figure 10. Milford area distribution system showing Option D-3, new roadside feeder.....	21
Figure 11. Transmission system showing Option T-1, G148 South Milford-Long Hill.....	22
Figure 12. Transmission system showing Option T-2, South Milford-Reeds Ferry.....	23
Figure 13. Transmission system showing Option T-3, South Milford-Eagle.....	24
Table 1. South Milford transformer information.....	6
Table 2. South Milford distribution circuit breakers sorted by age.....	6
Table 3. South Milford Substation historical and forecast loads.....	9
Table 4. South Milford feeder capacity and forecasted load levels.....	10
Table 5. Risk to customer load for South Milford Substation contingencies.....	11
Table 6. Risk to customer load for South Milford feeder contingencies.....	12

REDACTED

South Milford Substation Study

System Description, Design Violations and System Limitations



Figure 1. South Milford Substation viewed from Hammond Road, Milford.



Figure 2. Overview of the Transmission and Distribution system in the Milford area.

Green-double dash = 345 kV, Black-dash = 115 kV, Red = 34.5 kV

REDACTED

South Milford Substation Study



Figure 3. Milford area distribution system.

South Milford Substation Study

Overview

The Milford area has two primary bulk system supply sources.

- 1) South Milford Substation, 115-34.5 kV – Single 44.8 MVA transformer
- 2) Amherst Substation, 345-34.5 kV – Two 140 MVA transformers

South Milford Substation is a unique set-up in the Eversource New Hampshire system. Its design has two 34.5 kV buses, one with two 34.5 kV distribution supply lines from Amherst Substation (345-34.5 kV) feeding three feeders and the other supplied by 115-34.5 kV transformer TB86 (2014 Delta Star) feeding two feeders. The bus tie between the two bus sections is operated normally open. Capacity of Bus 2, the bulk-substation portion of the station, is noted in Table 1. Refer to Figure 6 for the substation one-line diagram.

	Mfg. Year	Condition Code ¹	Nameplate	LTE	STE	LCC
TB86	2014	1 – Green	44.8	55	67	
Substation			44.8			35.7

Note 1: Transformer condition code as of May 2020.

Table 1. South Milford transformer information

The two supply lines from Amherst, operated in parallel/looped configuration, are a combination of roadside and right-of-way, serving customers between the two substations. The 3212X is mostly 336 ACSR and the 3143X is 477 ACSR.

Of the nine distribution circuit breakers at South Milford, eight are oil circuit breakers ranging from 34 to 66 years old (Table 2).

Position	Type	Manufacturer	Date
BT36	Oil Circuit Breaker	General Electric	1955
314	Oil Circuit Breaker	General Electric	1967
329	Oil Circuit Breaker	General Electric	1967
378	Oil Circuit Breaker	General Electric	1967
TB86	Oil Circuit Breaker	General Electric	1967
32120	Oil Circuit Breaker	General Electric	1968
3217	Oil Circuit Breaker	General Electric	1978
31430	Oil Circuit Breaker	McGraw Edison	1987
3155	SF6 Circuit Breaker	Siemens	2004

Table 2. South Milford distribution circuit breakers sorted by age.

The 115-34.5 kV transformer TB86 is supplied by the 115 kV W157 line, a radial tap on a three-terminal line between Reeds Ferry Substation and Eagle Substation (Figure 4).

REDACTED

South Milford Substation Study

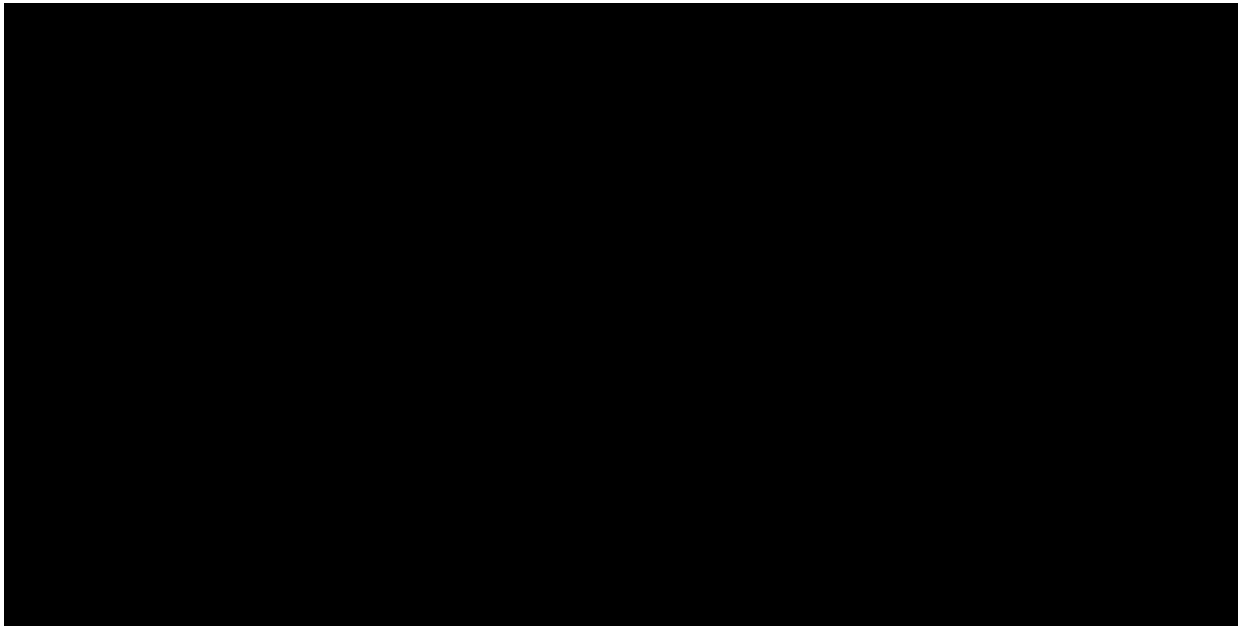

Figure 4. Transmission one-line of the system supply to South Milford.

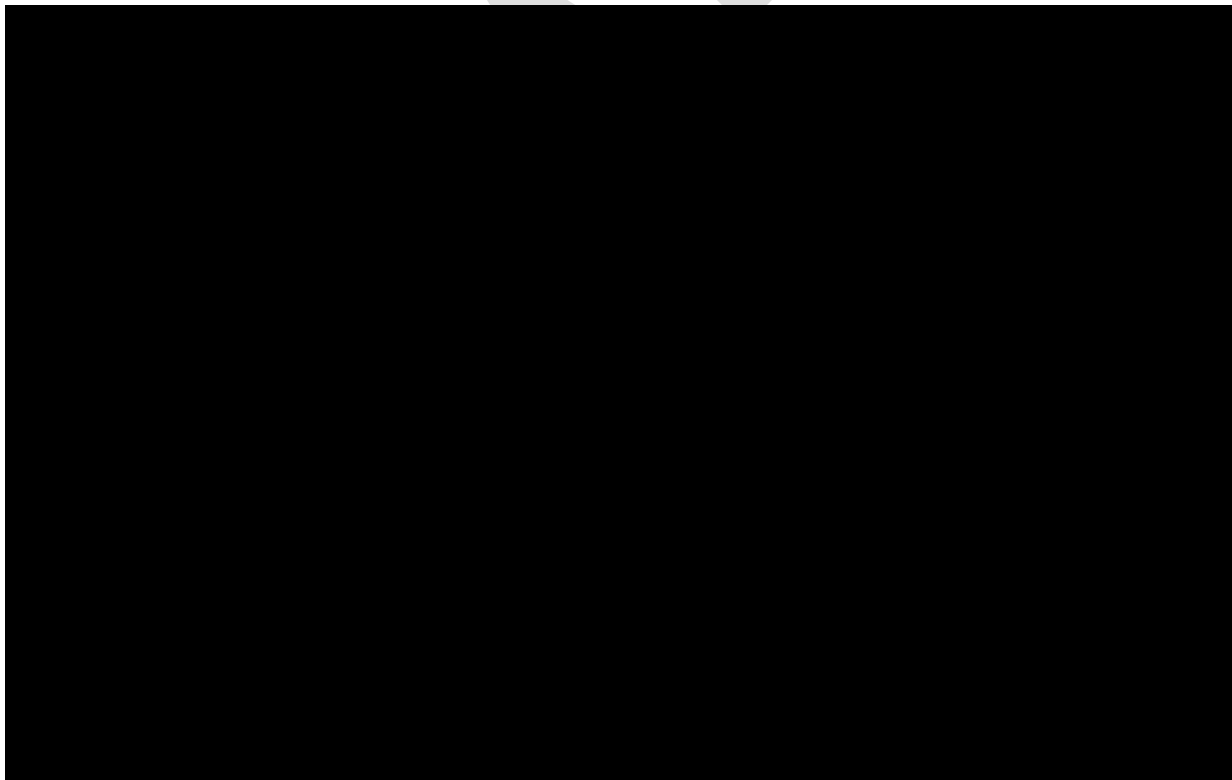

Figure 5. Geographic map of the transmission system in the Nashua-Milford area.

Cyan = 345 kV, Blue = 115 kV

REDACTED

South Milford Substation Study

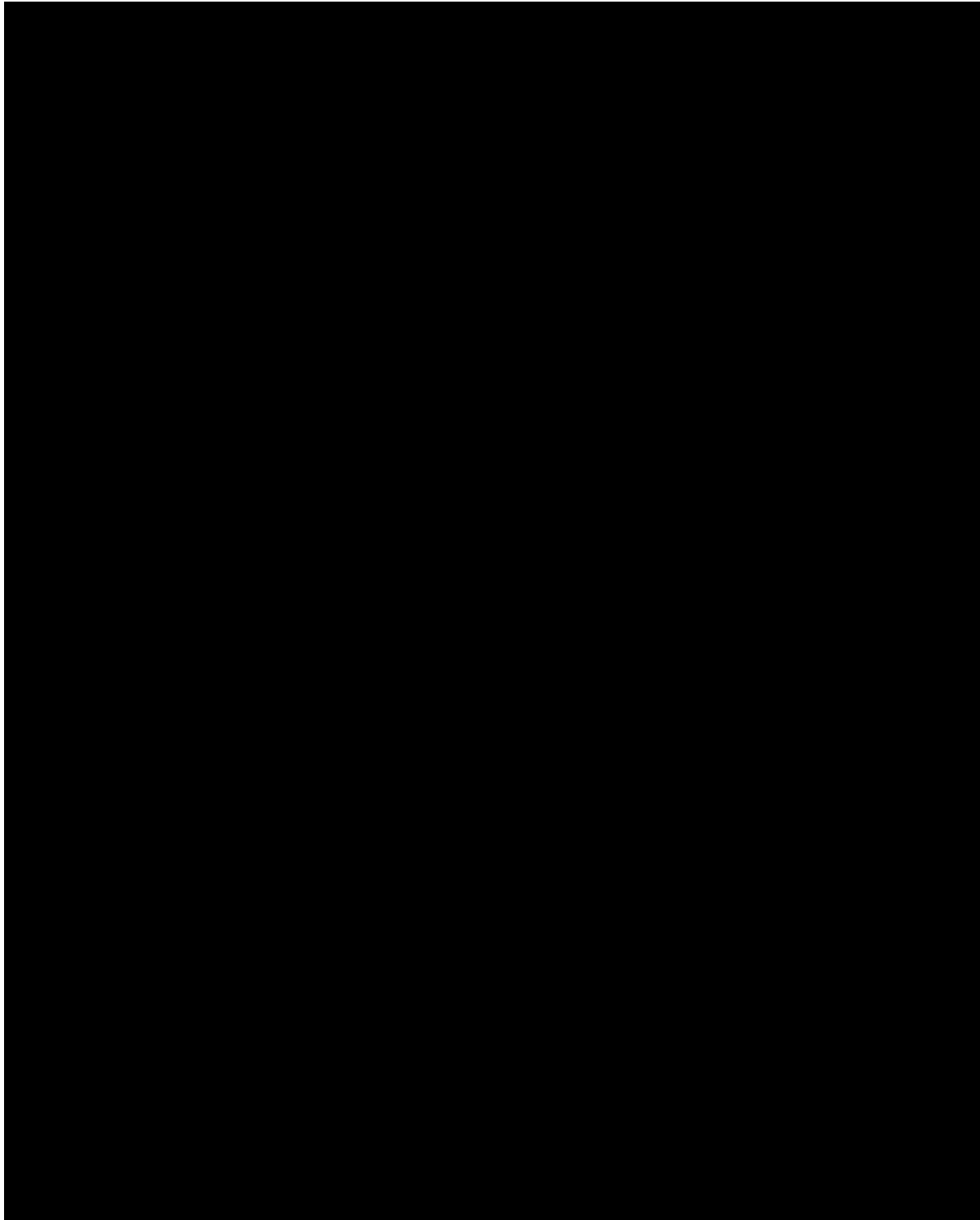

Figure 6. Substation One-Line of South Milford.

N-0, Base Case

Substation

Per the Distribution System Planning Guide, bulk substation transformers that provide back-up supply to other stations shall be loaded to no more than 95% of their nameplate rating, where the 95% preload is utilized in the development of emergency ratings of transformers. It should be noted that operating the transformer to 100% nameplate is not restricted with this criterion.

Historical loads have exceeded the 95% threshold three times; 2011, 2018 and 2020. This loading data has been corrected for temporary circuit reconfigurations (i.e., summer incident mitigation switching).

Recent increases in load can be attributed to two things:

- 1) Moving the open point between Milford 23X6 (Amherst supply) and West Milford 314X12 (South Milford supply) closer to Milford. Formerly open at Old Wilton Road 14X12J23, now open at Perham road 23X6J2. During the summer of 2020, peak loading was at about 4 MW for this section.
- 2) A manufacturing customer has seen growth at its campus with the addition of a new facility. It is anticipated to bring an additional 9 MW of load over the course of 2019-2023.

It has been identified that the peak 90/10 forecast exceeds the nameplate capacity of the 44.8 MVA transformer. This forecast is based on historical loading, state-level econometric data, new customer growth spot loads, and new large distributed energy generator interconnections.

	Customers Served	2020 Peak (MW)	2021 Forecast (MW)	2029 Forecast (MW)
Bus 1 (Amherst Supply)	12,191	37.4	37.5	38.4
Bus 2 (South Milford TB86)	13,608	44.3	48.6	49.3
Total Substation Load	25,799	81.7	86.1	87.7

Table 3. South Milford Substation historical and forecast loads.

With historical loads adjusted to account for transfers offloading transformer TB86, it was found that in 2018 that the hourly average load exceeded 95% of nameplate for three hours on one day. In 2020, load normally supplied by TB86 exceeded 95% of its nameplate for 15 hours over five separate days, with the longest duration being 5 hours and at a maximum capacity gap of 2.18 MW.

South Milford Substation Study

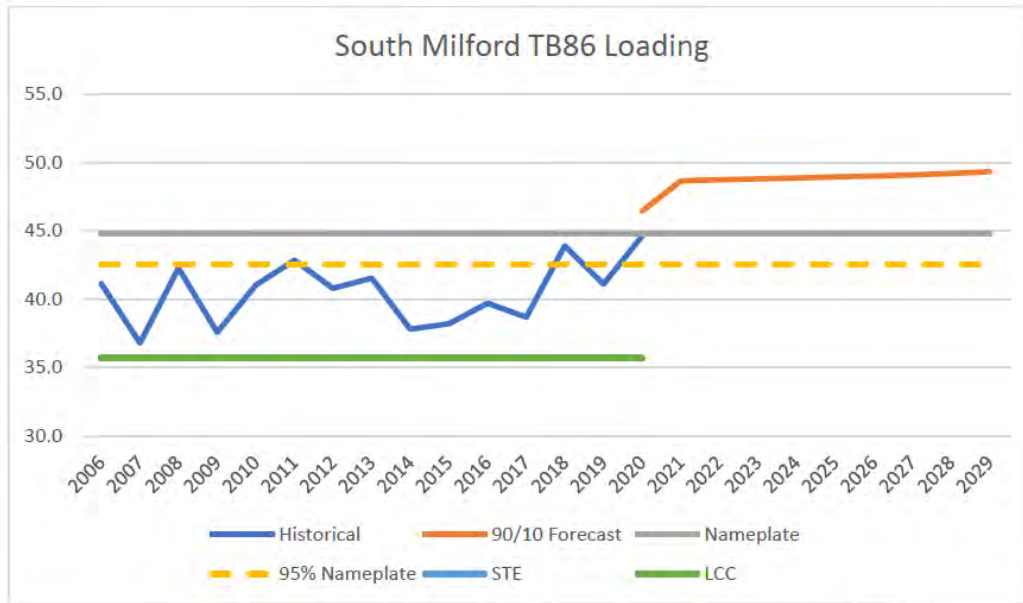

Figure 7. Historical trend and forecast load levels for South Milford transformer TB86.

Distribution Feeder

The Distribution System Planning Guide indicates that for any feeder whose load has reached 90% of its Normal capacity should be identified and a resolution for loading planned. Loading on the feeder shall not exceed 100% of its Normal ratings. Feeder loading at South Milford Substation is as follows in Table 4.

Feeder	Customers Served ¹	Feeder Capacity (MVA)	Limiting Element	2021 Load Supplied (MW)	2029 Load Supplied (MW)	2021 Percent Load (%)	2029 Percent Load (%)
314	5,885	32.3	336 ACSR 18/1	29.1	29.4	90	91
329	882	20.0	266 ACSR 6/7	3.2	3.2	16	16
378	7,773	40.0	477 ACSR 18/1	22.0	22.5	55	57
3143 ²	Supply Line	40.0	477 ACSR 18/1	22.3	22.8	56	57
3155	7,723	40.0	477 ACSR 18/1	19.5	19.8	49	50
3212 ²	Supply Line	32.3	336 ACSR 18/1	15.2	15.6	48	49
3217	3,536	40.0	477 ACSR 18/1	12.4	12.7	31	32

Note 1: Customer counts as of October 14, 2020

Note 2: 3143 and 3212 Feeder Capacity is based upon line capacity at South Milford, not the feeder capacity at Amherst

Table 4. South Milford feeder capacity and forecasted load levels.

South Milford Substation feeder 314 has reached the “take notice” 90% threshold identified in the planning guide. A solution to address loading on this line will need to be developed.

South Milford Substation Study

N-1, Contingency

Transmission

With appropriate design of the transmission system, a single transmission contingency shall not result in a condition greater than a single contingency at the distribution bulk substation. With South Milford’s design of a radial transmission line and single bulk substation transformer, it presently meets this design criteria.

Substation

The Distribution System Planning Guide directs that the Eversource distribution system shall be designed to sustain any loss of a bulk substation bus section, bus tie breaker, or transformer with no sustained load loss. Restoration switching upon a contingency event is limited to three load block transfers, one of which may be a cascading step. A cascading step is one that increases capacity at a substation utilized for restoration. Eversource calculates a Load Carrying Capacity (LCC) for bulk substations that identifies the restoration capacity during an N-1 transformer event. Substation load cannot exceed the LCC.

Element	Type	Customers Affected ¹	Load Affected ² (MW)	LCC (MW)	Load Block Transfers	Sustained Load Loss (MW)	Customers Adversely Impacted
TB86	115-34.5 kV Transformer	13,608	48.6	25.4	2	23.2	4,727
Bus 1	Distribution Bus	12,191	37.6	n/a	3	8.4	3,098
Bus 2	Distribution Bus	13,608	48.6	n/a	2	23.2	4,727
BT36	Bus Tie Breaker	25,799	86.2	n/a	3	57.0	16,706

Note 1: Customer counts as of October 14, 2020

Note 2: Loading data is derived from the 2021 South Milford Substation 90/10 forecast

Table 5. Risk to customer load for South Milford Substation contingencies

The resulting sustained load loss above in Table 5 is due to thermal line capacity restrictions of the two supply lines from Amherst Substation. Alternatively, line and transformer capacity prohibit significant restoration from Bridge Street Substation in Nashua via the Broad Street switching station.

All contingencies of noted substation elements will cause an event that violates Eversource’s design criteria.

Distribution Feeder

34.5 kV Distribution feeder contingencies are covered by Eversource New Hampshire’s ED-3002 Distribution System Planning and Design Criteria Guidelines, which relies on a mobile substation solution

South Milford Substation Study

allowing for 30 MW of isolated load following three load blocks of restoration switching. The company's intention is to migrate towards a 0 MW threshold for non-radial feeders at a bulk substation.

Feeder	Communities Served	Customers Served ¹	Load Supplied ² (MW)	Load Block Transfers	Sustained Load Loss (MW)	Customers Adversely Impacted
314	Lyndeborough, Mason, Milford, Mont Vernon, Temple, Wilton	5,885	29.1	2	0	0
329	Brookline, Hollis	882	3.2	1	0	0
378	Amherst, Milford, Mont Vernon	7,773	22.0	2	6.2	2,145
3143	Supply Line	n/a	n/a	1	0	0
3155	Brookline, Mason, Milford, New Ipswich, Peterborough, Sharon, Temple	7,723	19.5	0	0	0
3212	Supply Line	n/a	n/a	1	0	0
3217	Hollis, Nashua	3,536	12.4	1	0	0

Note 1: Customer counts as of October 14, 2020

Note 2: Loading data is derived from the 2021 South Milford Substation 90/10 forecast

Table 6. Risk to customer load for South Milford feeder contingencies

While presently none of the feeders at South Milford violate any design criteria, loss of South Milford feeder 378 produces an event where customers will experience a permanent outage. System capacity limitations preclude additional switching from being performed to utilize the last remaining load block available in switching.

Distributed Generation Limitation at Amherst Substation

In 2010, Siemens/PTI performed a study for adding 10 MW synchronous generation at a customer facility supplied by the 345-34.5 kV Timber Swamp Substation in Hampton, New Hampshire. It was found that:

- Single line-to-ground transmission fault causes temporary overvoltage with all generation types and sizes (except small sizes), particularly at light load periods.
- No-fault temporary overvoltage exists with small to moderate sized generation during light load periods.

The 345 kV system is effectively grounded. This limits the voltage rise on the unfaulted phases during line-to-ground faults to levels which do not exceed the withstand capability of the phase to ground insulation and surge arresters. However, if the 345 kV system is isolated from all ground sources and then back energized from the delta winding of TB25, a ground fault in the connected 345 kV system will result in full neutral displacement on the unfaulted phases. This means that those phases will then be at

least at full phase-to-phase voltage above ground. Depending on system configuration and the consequent additional voltage rise created by the “no-fault” problem, the voltages could be even higher. This can fail certain phase to ground insulation systems and surge arresters. In general, fully insulated delta windings in power transformers can withstand full neutral displacement of normal system voltages for some time. Other connected system elements may not be as robust.

The study concluded that with capacitance on the 34.5 kV distribution system and the addition of the 10 MW synchronous generator at the customer facility, this would cause temporary overvoltage exceeding the transformer capabilities during a transmission single line-to-ground fault scenario. Temporary overvoltage exists for specific transmission configurations with the addition of the generator to the distribution system during no-fault scenarios. The study also noted that for inverter-based generators, a temporary overvoltage exists during a transmission single line-to-ground fault scenario as well, though no issues during no-fault conditions.

Resulting from the outcome of the study, Eversource has decided that no more than 5 MW of generation can be installed on its 345 kV supplied substations (Amherst, Lawrence Road, and Timber Swamp) in order to protect its equipment.

Parallel Distribution Supply Lines: Amherst-South Milford

The supply lines for South Milford Bus 1 originate at the 345-34.5 kV Amherst Substation. The 3143X and 3212X lines serve distribution customers along the way to South Milford and are operated in a parallel configuration, both serving the load at South Milford.

While this configuration provides a conduit for utilizing the capacity of Amherst Substation and has some reliability benefit, it does bring a series of disadvantages affecting safety, protection, and operation of the distribution system. Operating distribution lines in parallel or with multiple sources from different stations has the following drawbacks:

- Higher fault current duty due to multiple sources feeding into the fault
- Higher arc flash energy and risk to equipment and personnel
- Accuracy is lost in identification of fault locations based on relay recordings due to sequential clearing of devices, leading to slower restoration response
- Need to develop and maintain load protection schemes to prevent damage of the unaffected line during a line fault contingency
- Increased engineering costs for development of protection settings

Considering this, Eversource has been making an effort to eliminate these conditions and configure the system to radial operation. Any system reliability impacts due to elimination of the parallel configuration are balanced by improved location identification for isolating the faulted line section and timely restoration response.

Solution Needs and Options

The above planning criteria is intended to maintain safe, reliable operation of the distribution system. Based on the noted design violations, solution options to bring South Milford Substation into compliance with Eversource's criteria must address the following:

- Reduce load or increase transformer capacity at South Milford
- Reduce load or increase system capacity to address LCC deficit at South Milford
- Reduce load or increase 314 feeder capacity
- Reduce load or increase 378 tie capacity

The possible opportunities to address capacity deficits by reducing existing load include non-traditional solutions such as battery storage, solar, energy efficiency, demand response as well as increasing capacity with traditional solutions of additional transformation and increasing feeder capacity with reconductoring or new construction. Unfortunately, due to the combination of the immediate need, an anticipated in-service date of year-end 2024, and the magnitude of the forecasted capacity deficit (MWh capacity gap), non-wires alternative solutions are not considered to be suitable.¹

The following review of possible solution options looks at the possible options need-by-need. Ultimately the most viable and cost-effective suite of options will be selected to resolve all design violations.

Base Case Capacity

Substation

At a high-level scope, the following options can address base case loading/capacity issues:

1. Replace the 44.8 MVA transformer with a 62.5 MVA transformer; or
2. Add a second transformer at South Milford Substation and reconfigure distribution feeder terminals to balance loading on the two transformers.

Other options considered, but are significantly greater in scope than upgrades at South Milford:

345-34.5 kV Substations – Load transfers to Amherst or a new Colburn Road Substation would not be in our customers' best interest with the present distributed generation limitation. Several studies have been performed on the 345-34.5 kV substations that have identified ferroresonance and temporary overvoltage scenarios on the ungrounded 345 kV system with the presence of more than 5 MW of generation on the distribution system. Eversource welcomes the addition of customer owned generation on the distribution system and expanding the area supplied by the 345 kV system would be restricting our customers' ability to add rooftop solar, utility scale solar and battery storage.

Broad Street Substation – As-is, Bridge Street (the supply to Broad Street) does not have enough capacity to accommodate significant additional load (15 MW of the 329 and 3217 lines aggravates an expected STE capacity violation). Adding transformation at the Broad Street switching station would address Nashua area capacity but would produce a situation where a single N-1 transmission contingency would cause N-4 on the distribution system. A new transmission line creating a loop

¹ Refer to the Eversource Non-Wires Alternative Framework

addresses this issue, however it strings three adjacent stations together on the same line and would be problematic for System Operations during any planned transmission outages within this loop.

Distribution Feeder

To increase capacity of South Milford 314, the following options exist:

1. Reconductor 3.3-miles of the 314 feeder from 336 ACSR to 477 spacer cable; or
2. Construct a new feeder via the 314 right of way from South Milford to the 314X12 West Milford Tap; or
3. Construct a new feeder via the 378 right of way from South Milford to Milford Substation; or
4. Construct a new feeder roadside and overbuilt existing distribution from South Milford to downtown Milford.

Contingent Capacity

Substation

For loss of a transformer event, increase the LCC of South Milford Substation by:

1. Addition of a second transformer, 62.5 MVA, at South Milford Substation.

Reconductoring 3.41 miles of the 3212 feeder from 336 ACSR to 477 spacer cable to increase capacity of the supply from Amherst to South Milford was considered, but this solution option would extend the use of a non-preferred operating configuration. As noted earlier in this report, Eversource has been making an effort to remove operating conditions with parallel lines when possible.

Loss of distribution Bus 2 is resolved with the increase in the LCC, but for loss of Bus 1 (Amherst supply) an increased capacity is required by:

1. Replacement of the 44.8 MVA transformer with a 62.5 MVA transformer.

With a bus tie breaker failure scenario, two solution options exist:

1. Addition of a series bus tie breaker with BT36; or
2. Replacement of the distribution equipment with a double-bus 34.5 kV switchgear.

Any need to rebuild the substation extensively or on a green-field site (fresh, new construction) would prompt the substation to be built with double-bus distribution switchgear, which is Eversource's standard basic bulk substation design. Also, replacement of the existing distribution equipment with double-bus switchgear will address removal of the vintage oil-filled circuit breakers from the Eversource system.

Distribution Feeder

For loss of the 378 feeder at South Milford, sustained load loss can be addressed by:

South Milford Substation Study

1. Construction of a new 3.3-mile feeder via the 314 right of way from South Milford to the 314X12 West Milford Tap; or
2. Construction of a new 1.5-mile feeder via the 378 right of way from South Milford to Milford Substation; or
3. Construction of a new 1.5-mile feeder roadside and overbuilt existing distribution from South Milford to downtown Milford.

Reconductoring 3.3 miles of the 314 line from 336 ACSR to 477 spacer cable and upgrading the West Milford 314X12 line regulators was considered, however the regulators at West Milford are already Eversource's maximum size of 335-amps.

For all new feeder options, the new line would offload the 314X12 tap load from the 314 line and the 23X6 from the 378 line.

Transmission Contingency

The contingency solution of adding a second transformer at South Milford, which is fed from a radial transmission line, would violate System Planning design criteria in that a transmission contingency would lead to two contingencies on the distribution system. To resolve this, an additional transmission project will be required to bring in a second 115 kV supply into South Milford.

Options for a second supply into South Milford include:

1. Construction of the 10.78-mile 115 kV G148 line from South Milford to Broad Street Substation, completion of the 4.62-mile 115 kV G148 line from Broad Street to Long Hill to complete a transmission loop of the radial W157 and P134, and rebuild Long Hill and South Milford with ring bus configurations; or
2. Construction of a new 10.78-mile 115 kV line from South Milford to Reeds Ferry Substation in the W157 and H123 corridors and rebuild South Milford and Reeds Ferry with ring bus configurations; or
3. Construction of a new 7.64-mile 115 kV line from South Milford to Eagle Substation in the W157 and H123 corridors and rebuilt South Milford with a ring bus configuration.

Outside of solving the needs identified for South Milford, the G148 solution option has the added benefit of resolving a Transmission N-1 contingency design violation at Long Hill Substation. For loss of the radial P134 between Power Street and Long Hill, a contingency greater than N-1 is caused at Long Hill Substation. Long Hill Substation contains two 44.8 MVA bulk transformers. Refer to Figure 5 for location relative to the focus study area of South Milford.

Preferred and Alternative Solutions

The solution options presented here resolve all the identified deficiencies in the electric system at South Milford Substation. The scope of these options, including preference, are based on preliminary information. With further cost estimate development and conceptual engineering performed, these options will be refined and additional analysis will be performed. As the estimates and design reviews

are completed, the scope and description of each option and the designation of preferred option will be re-evaluated. Decision matrices identifying the preferred solutions can be found in Appendix B.

Distribution

With these distribution solution options, all include replacement and installation of a second transformer at South Milford as this is the only reasonable solution in size of scope for resolving South Milford contingency capacity. With this vastly increased capacity, the 3143 and 3212 lines from Amherst would be operated radial from Amherst Substation. Transformation at South Milford be the source for all load presently served from South Milford Bus 1 (Amherst supply).

To address the identified design violations, the following suite of projects are being proposed:

Preferred, Distribution Solution #D-1

Solution option D-1 consists of capacity upgrades at South Milford, reconfiguration of the 34.5 kV distribution system, and the construction of a new 34.5 kV feeder parallel to the 378 line from Nashua Street to Milford Substation to offload the 23X6 and 314X12 from their existing supply lines.

See Figure 8 for the routing of this new line.

Order of magnitude estimate: \$

- Replace the existing 44.8 MVA transformer with a 62.5 MVA transformer
- Add a second transformer, 62.5 MVA in size
- Replace distribution equipment with double-bus switchgear
- Construct a new 1.5 mile 34.5 kV feeder along with the 378 line
 - Utilize the 3212 for 0.82 miles from South Milford to Nashua Street
 - Double-circuit with the 378 for 0.68 miles within the 378 right of way

Alternative, Distribution Solution #D-2

Solution option D-2 consists of capacity upgrades at South Milford, reconfiguration of the 34.5 kV distribution system, and the construction of a new 34.5 kV feeder parallel of the 314 line from South Milford Substation to the 314X12 tap near Whitten Road to offload the 23X6 and 314X12 from their existing supply lines.

See Figure 9 for the routing of this new line.

Order of magnitude estimate: \$

- Replace the existing 44.8 MVA transformer with a 62.5 MVA transformer
- Add a second transformer, 62.5 MVA in size
- Replace distribution equipment with double-bus switchgear
- Construct a new 3.3 mile 34.5 kV feeder in the 314 right of way
 - Double-circuit with the 314 line for 3.3 miles

South Milford Substation Study

Alternative, Distribution Solution #D-3

Solution option D-3 consists of capacity upgrades at South Milford, reconfiguration of the 34.5 kV distribution system, and the construction of a new 34.5 kV feeder from South Milford Substation to a point west of the downtown area to connect with the 23X6 to offload the 23X6 and 314X12 from their existing supply lines.

See Figure 10 for the routing of this new line.

Order of magnitude estimate: \$

- Replace the existing 44.8 MVA transformer with a 62.5 MVA transformer
- Add a second transformer, 62.5 MVA in size
- Replace distribution equipment with double-bus switchgear
- Construct a new 1.5 mile roadside 34.5 kV feeder through Milford

REDACTED

South Milford Substation Study

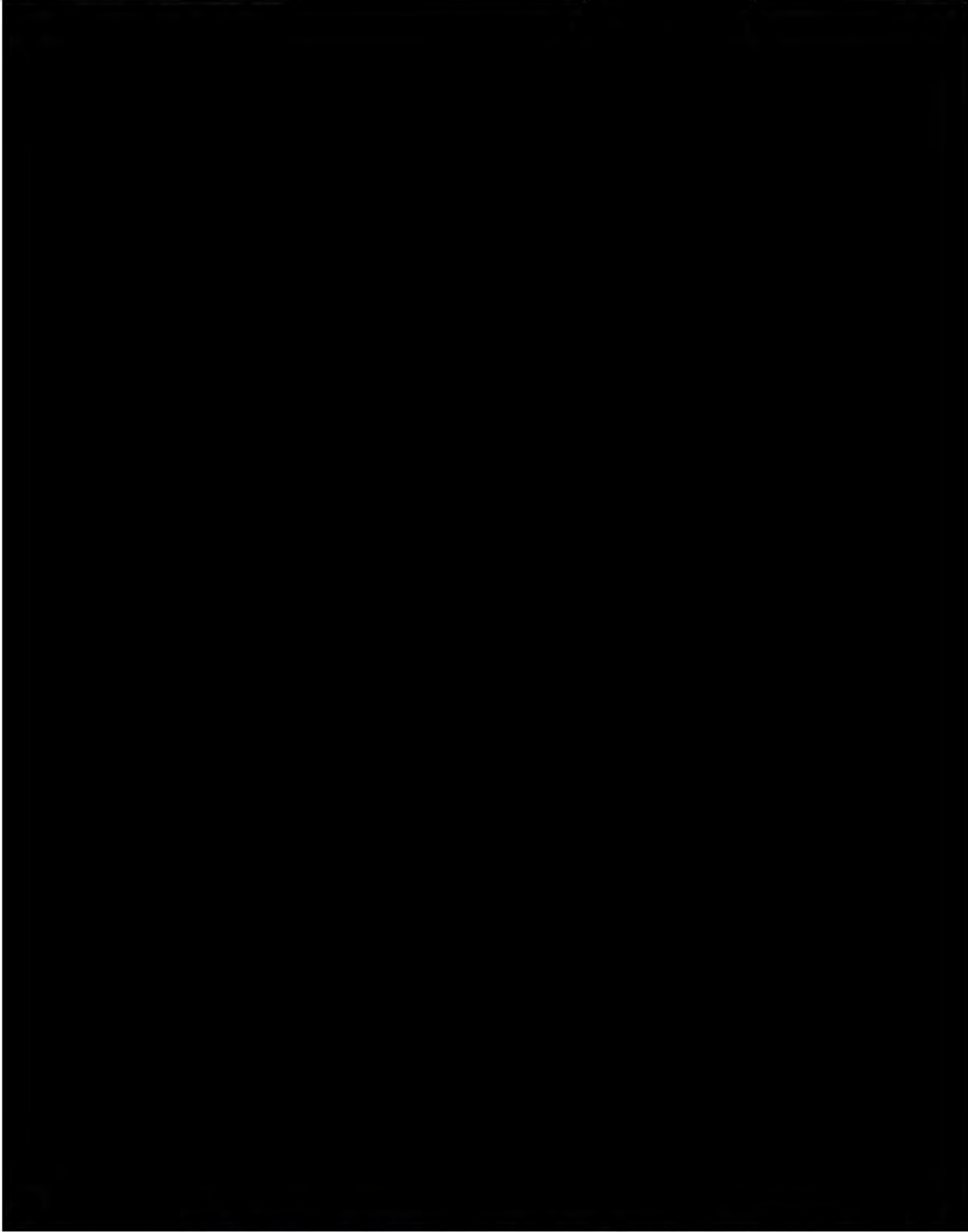

Figure 8. Milford area distribution system showing Option D-1, new feeder in 398 right-of-way.

REDACTED

South Milford Substation Study

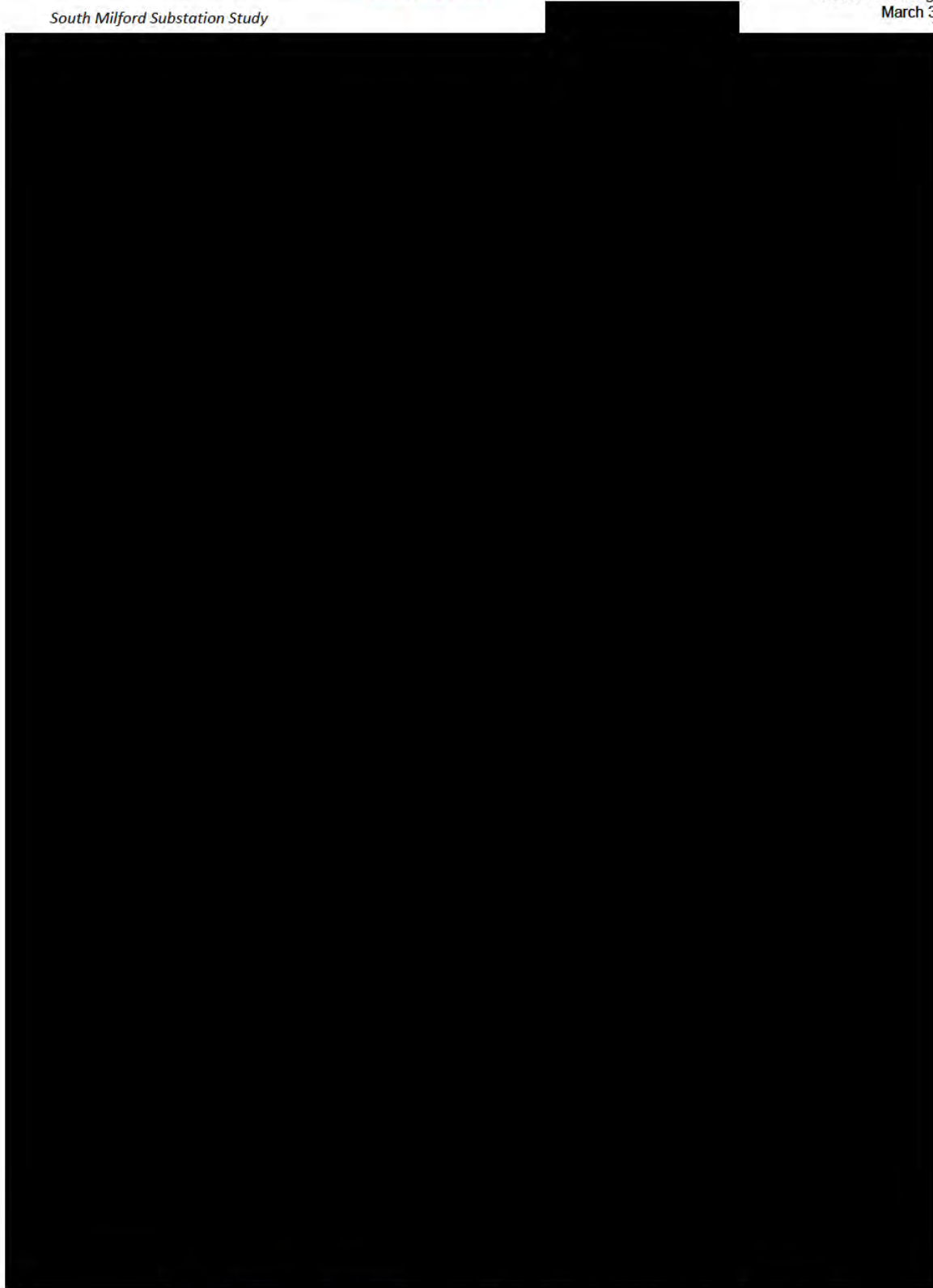

Figure 9. Milford area distribution system showing Option D-2, new feeder in 314 right-of-way.

REDACTED

South Milford Substation Study

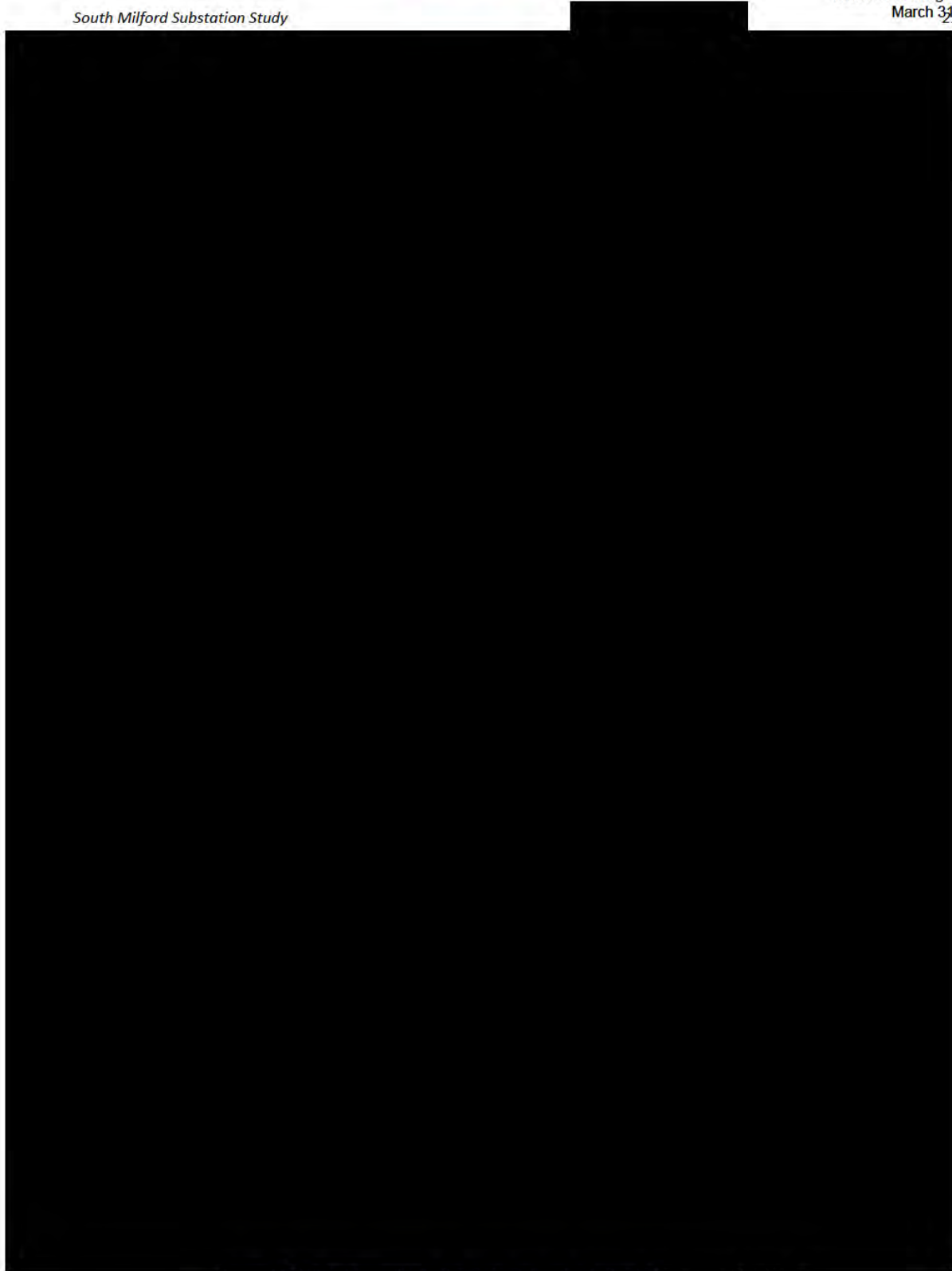

Figure 10. Milford area distribution system showing Option D-3, new roadside feeder.

REDACTED

South Milford Substation Study

Transmission

As a result of the distribution solution adding a second transformer at South Milford, a transmission solution is necessary to resolve a transmission contingency causing a greater than N-1 distribution contingency at South Milford.

Further study of the effects of adding the new transmission line must be undertaken by Transmission Planning to determine if additional upgrades are required for any of these solution options.

Preferred, Transmission Solution #T-1

Solution option T-1 consists of station upgrades at the terminals of South Milford and Long Hill and the construction of a new transmission line from South Milford Substation to the Broad Street switching station. Utilize already constructed G148 to reach Long Hill Substation.

Order of magnitude estimate: \$

- Construct a new 10.78 mile 115 kV line from South Milford to Broad Street in the G148 right of way with the 34.5 kV 329 line underbuilt
- Utilize 4.62 miles of existing G148 structures from Long Hill to Broad Street
- Rebuild South Milford Substation with ring-bus transmission yard
- Rebuild Long Hill Substation with ring-bus transmission yard

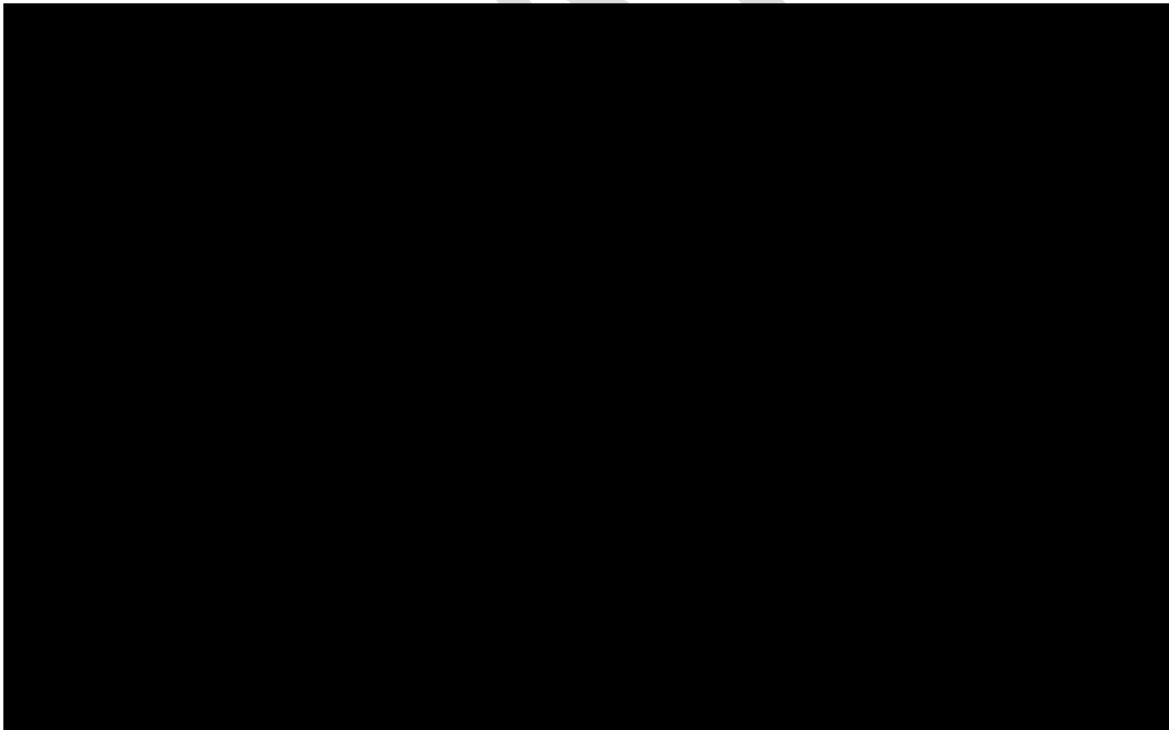

Figure 11. Transmission system showing Option T-1, G148 South Milford-Long Hill.

REDACTED

*South Milford Substation Study***Alternative, Transmission Solution #T-2**

Solution option T-2 consists of station upgrades at the terminals of South Milford and Reeds Ferry and the construction of a new transmission line parallel with the W157 and H123 from South Milford Substation to Reeds Ferry Substation.

Order of magnitude estimate: \$

- Relocate 9.78 miles of the W157 within its right of way to accommodate a new line
- Construct a new 10.78 mile 115 kV line from South Milford to Reeds Ferry
- Rebuild South Milford Substation with ring-bus transmission yard
- Rebuild Reeds Ferry Substation with ring-bus transmission yard

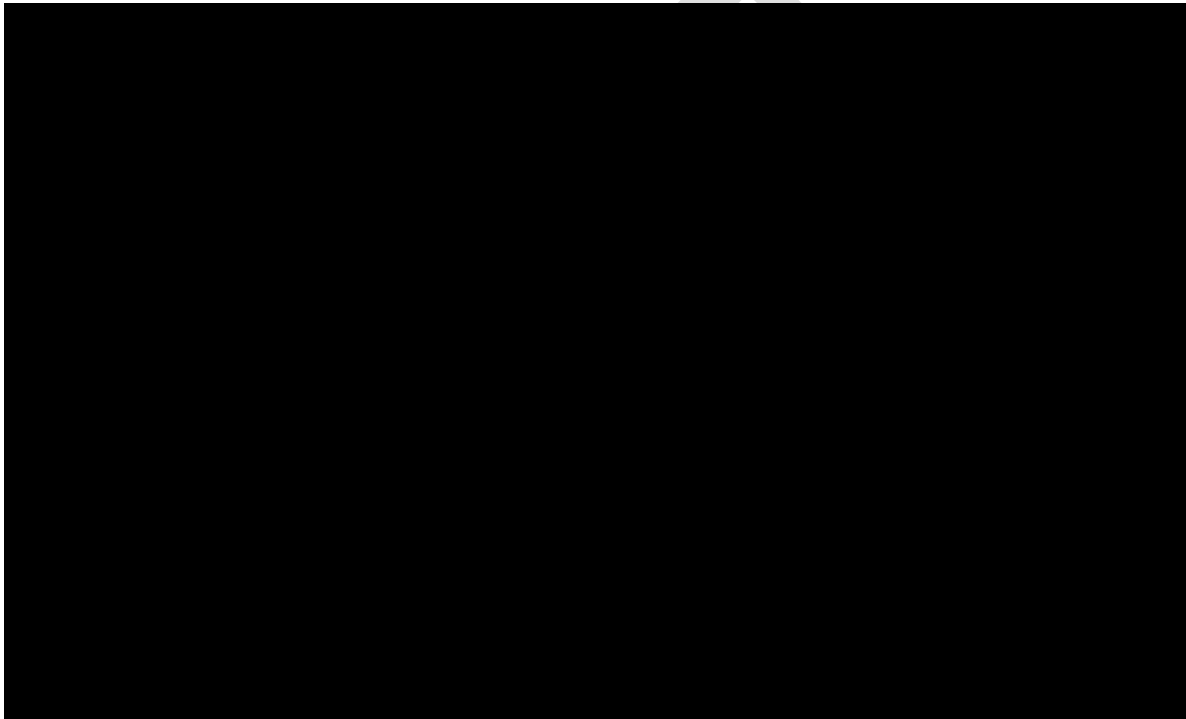

Figure 12. Transmission system showing Option T-2, South Milford-Reeds Ferry.

REDACTED

*South Milford Substation Study***Alternative, Transmission Solution #T-3**

Solution option T-3 consists of station upgrades at the terminals of South Milford and Eagle and the construction of a new transmission line parallel with the W157 and H123 from South Milford Substation to Eagle Substation.

Order of magnitude estimate: \$

- Relocate 9.78 miles of the W157 within its right of way to accommodate a new line
- Construct a new 12.8 mile 115 kV line from South Milford to Eagle
- Rebuild South Milford Substation with ring-bus transmission yard
- Add a 115 kV string to Eagle Substation or relocate O149 line to Bus 2 and bring the new line into the bay position

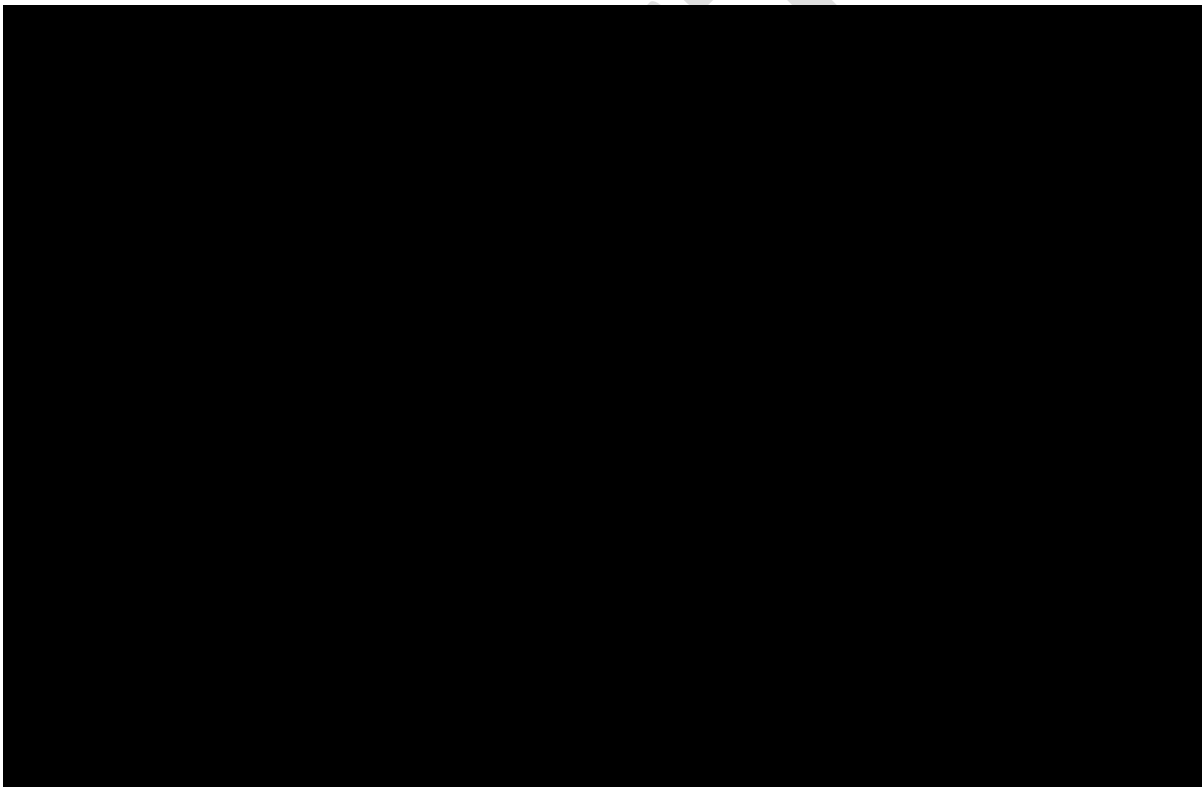

Figure 13. Transmission system showing Option T-3, South Milford-Eagle.

South Milford Substation Study

Appendix A – Order of Magnitude Project Estimates

Basis for Order of Magnitude Estimates

Right of Way Line Estimates

Distribution Line – Right of Way	\$1.0M/mile
Distribution Line, additional – Right of Way	\$550k/mile
Distribution Line, overbuilt – Roadside	\$1.0M/mile
Transmission Line	\$2.5M/mile
Transmission Line, addition	\$1.4M/mile

Substation Estimates

Replacement of 44.8 MVA transformer with 62.5 MVA	\$8M
Addition of a second transformer, 62.5 MVA	\$5M
Distribution 34.5 kV double-bus switchgear	\$
Construct a transmission ring bus	\$

Distribution Line Solution Option Estimates

Option D-1: Construction of a new 0.68 mile 34.5 kV line in the 398 line ROW

Transformer replacement, 44.8 MVA with 62.5 MVA	\$8M
Transformer addition, 62.5 MVA	\$5M
Replacement of distribution equipment with double-bus switchgear	\$
Double-circuit with 378 line for 0.68 miles	\$1.1M
Total:	\$

Option D-2: Construction of a new 3.3 mile 34.5 kV line in the 314 line ROW

Transformer replacement, 44.8 MVA with 62.5 MVA	\$8M
Transformer addition, 62.5 MVA	\$5M
Replacement of distribution equipment with double-bus switchgear	\$
Double-circuit with 314 line for 3.3 miles	\$5.2M
Total:	\$

South Milford Substation Study

Option D-3: Construction of a new 1.5 mile 34.5 kV roadside line through Milford

Transformer replacement, 44.8 MVA with 62.5 MVA	\$8M
Transformer addition, 62.5 MVA	\$5M
Replacement of distribution equipment with double-bus switchgear	\$
Line construction, 1.2 miles of double-circuit, 0.3 of triple-circuit	\$2.0M
Total:	\$

Transmission Line Solution Option Estimates

Option T-1: Construction of new G148 115 kV line

Transmission line, double circuit with 329 line for 10.78 miles	\$33.0M
Construct a ring bus transmission yard at South Milford	\$
Construct a ring bus transmission yard at Long Hill	\$
Total:	\$

Option T-2: Construction of new 115 kV line from South Milford to Reeds Ferry

Relocate W157 within the right of way for 9.78 miles	\$24.5M
New 115 kV line within the W157 right of way for 9.78 miles	\$24.5M
New transmission line in H123 corridor for 1.00 miles	\$2.5M
Construct a ring bus transmission yard at South Milford	\$
Construct a ring bus transmission yard at Reeds Ferry	\$
Total:	\$

Option T-3: Construction of new 115 kV line from South Milford to Eagle

Relocate W157 within the right of way for 9.78 miles	\$24.5M
New 115 kV line within the W157 right of way for 9.78 miles	\$24.5M
New transmission line in H123 corridor for 3.02 miles	\$7.6M
Construct a ring bus transmission yard at South Milford	\$
Build out a new string at Eagle Substation or relocate Busch O149	\$10M
Total:	\$

South Milford Substation Study

Appendix B – Decision Matrices

Distribution Solution Options

Weight		Rating 4-5 = Superior, 2-3 = Adequate, 0-1= Inferior		
		Option D-1: New Line 378 ROW	Option D-2: New Line 314 ROW	Option D-3: New Line Roadside
Addresses Dist. System Planning Guide & ED-3002 Design Criteria	8	5	5	5
Addresses Area Load Growth (Long Term, 10 Years)	8	5	5	5
Improves Reliability: SAIDI	8	4	4	4
Project Cost	7	5	2	4
Environmental Impact	5	3	2	4
Contingency Solution	5	5	5	5
Customer Exposure	4	5	5	1
Operating Cost	3	4	4	5
System Loss Savings	3	4	2	4
Total		231	199	216

South Milford Substation Study

Transmission Solution Options

Weight		Rating 4-5 = Superior, 2-3 = Adequate, 0-1= Inferior		
		Option T-1: New Line to Long Hill	Option T-2: New Line to Reeds Ferry	Option T-3: New Line to Eagle
Addresses Dist. System Planning Guide & ED-3002 Design Criteria	8	5	3	3
Addresses Area Load Growth (Long Term, 10 Years)	8	3	3	3
Improves Reliability: SAIDI	8	5	3	3
Project Cost	7	5	4	4
Environmental Impact	5	3	3	3
Contingency Solution	5	5	3	3
Customer Exposure	4	5	3	3
Operating Cost	3	5	3	2
System Loss Savings	3	4	3	3
Total		226	160	157



PSNH dba Eversource Energy
Docket No. DE 20-161
Least Cost Integrated Resource Plan
March 31, 2021 Supplement
Appendix B-6
Page 1 of 5

Data-driven transformer replacement strategy

03/29/2021

000402

Transformer ranking formulation

Health index

Factors

- Age
- Normal degradation (ratings and DGA)
- Abnormal condition signatures
- Oil quality

Weights

- Age – 30%
- Normal degradation – 50%
- Abnormal condition – 15%
- Oil quality – 5%

Customer index

Factors

- Residential customers
- Commercial customers
- Critical facilities

Weights

- Residential – 20%
- Commercial – 35%
- Critical facilities – 45%

Physics rooted formulation

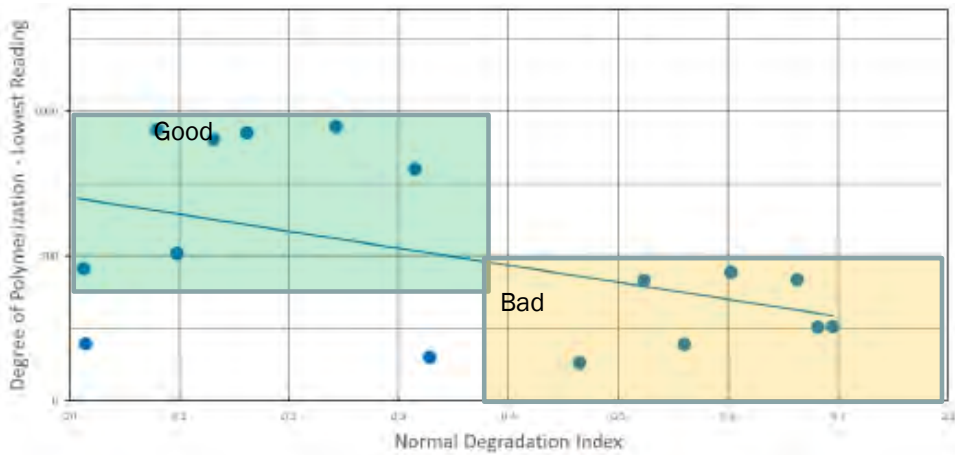

Analytics Assessment and Comparisons – EPRI Report 3002019254

Normal degradation index is directly correlated to the degree of polymerization. Paper with no mechanical strength left has measured dp of 200. Brand new paper with no aging has measured dp of close to 1000 or above. When dp drops under 500, it has lost most of the useful life.



PSNH dba Eversource Energy
Docket No. DE 20-161
Least Cost Integrated Resource Plan
March 31, 2021 Supplement
Appendix B-6
Page 4 of 5

Transformer ranking dashboard

Clear Filters

Refresh Date
3/3/2021 3:05:36 PM

Total Transformers
1141

Select Business Unit
All

Select Region
All

Select State
CT, EMA, NH, WMA

Select AWC
All

Select Equipment Type
All

Search Site Name
Search

Select Bulk Class
All

Select Manufacturer
All

Select Short Term Health Index
0.00 - 0.66

Select Customer Index
0.00 - 0.76

Select Long Term Health Index
0.00 - 0.72

Select Equipment Age
0 - 91

Degree of polymerization drops under 500 beyond the health index values > 0.5 indicating loss of useful insulation life and thus show potential replacement candidates.

Short Term Potential Replacement
10

Long Term Potential Replacement
40

Short Term Health Index by Customers Index

Long Term Health Index by Customers Index

Transformer Details																
Business Unit	Bulk Class	State	AWC	Region	Site Name	Equip ID	Equip Type	Equip Position	Equip Age yrs	Equip Status	Customers Index	Short Term Health Index	Short Term Total Index	Long Term Health Index	Long Term Total Index	Manuf:
D	Dist	CT	Norwalk Substations	West Substations	EAST ROCKS 17R	-9976698	LTCTransformer	17R-1X	53	inservice	0.03	0.66	0.66	0.33	0.33	Westing
D	Dist	WMA	Hadley Substations	ES-MA(W) Region Substations	GREENFIELD 28W	-9976434	LTCTransformer	28W-2X	63	inservice	0.03	0.65	0.65	0.43	0.43	General
D	Dist	NH	Chocorua AWC Substations	Northern Region Substations	Center Ossipee	-9999802	NoLTCTransformer	19W1	56	inservice	0.00	0.58	0.58	0.46	0.46	General
D	Dist	CT	Torrington Substations	West Substations	WATERTOWN 25R	-9976677	LTCTransformer	25R-1X	62	inservice	0.03	0.53	0.53	0.33	0.33	Westing
D	Bulk	CT	New London Substations	East Substations	Flanders 11Y	-9976576	LTCTransformer	11Y-2X	49	inservice	0.25	0.52	0.58	0.29	0.38	General
D	Bulk	CT	Hartford	Central	SOUTH	-9947630	LTCTransformer	1A-5X	46	inservice	0.21	0.52	0.56	0.27	0.34	Mcgraw

000405

How to analyze

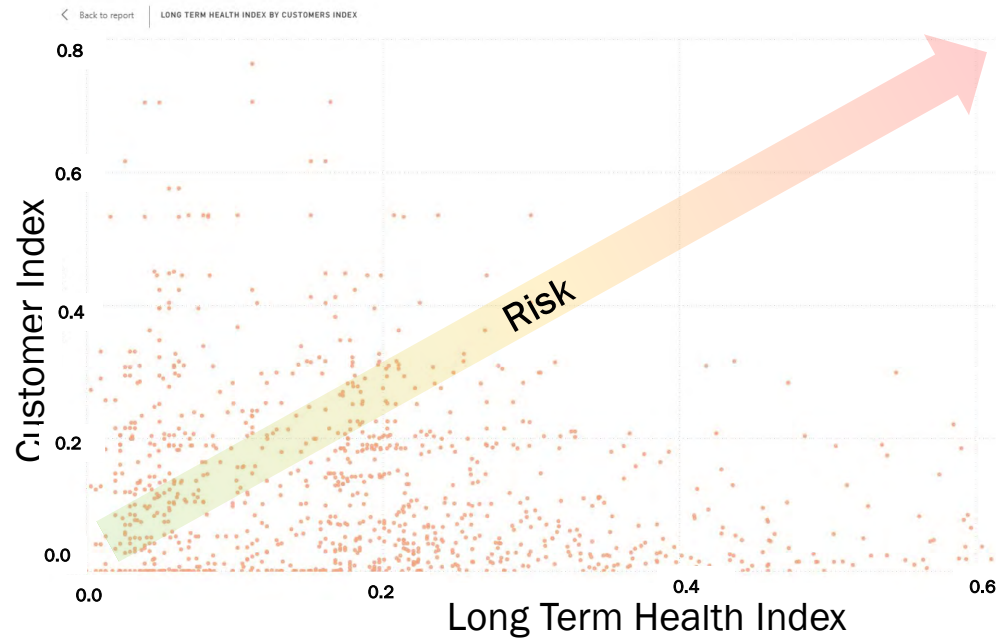

1. Choose investment levels
2. Break out transformers based on KVA/kV/geographical location as necessary
3. Create priority zones and select de-risking candidates
 1. Build contingency
 2. Replace
4. Periodically refresh the dataset and update priorities

000406

Appendix C: Proposed Reliability Projects

The “Proposed Reliability Projects” document provides a list of distribution line reliability projects that have been proposed but have not been funded by the 2021 or previous years capital budgets. These projects, as well as new projects developed during 2021, will be evaluated with the best projects selected for funding in 2022. Changes in reliability performance and asset condition, technological advances, and the relatively short lead time make an annual review of proposed distribution line projects the prudent means of identifying the best projects.

Proposed Reliability Projects (not funded in 2021 Capital Plan)

AWC	Circuit	Category	Project Type	Project Description	Hitlist Ranking	Cost Estimate	\$ / CMS	Customers Provided Backfeed - Circuit Ties
Bedford	311	Reliability	Obsolete Equipment	Remove 311 line tap into former Henniker S/S		\$72,000	n/a	
Bedford	13W1 / 21W1	Reliability	Obsolete Equipment	Replace Notre Dame S/S with MITS and replace Dunbarton Rd S/S with Padmounted step		\$3,512,000	n/a	
Bedford	3271X2 - 3108	Reliability	Circuit Tie	Tie the 3271X2 ckt to the 3108 Ckt along Rte 114 for a distance of 4.6 miles. Requires conversion.	#29 2016	\$3,500,000		5,280
Bedford	328/322	Reliability	Circuit Tie	Continue 3PH conversion down St A's drive for ckt tie. Approx 1650 ft left to complete.		\$157,000		1,252
Bedford	335X15-335X56	Reliability	Circuit Tie	Convert, reconductor, and fill in gap between the 335X15 and 335X56 circuits along Rte 3A in Hooksett				1,719
Bedford	360X5 - 322X10	Reliability	Circuit Tie	Tie 360X5 to 322X10 along New Boston Rd	#34-2013	\$1,418,016	\$7.30	1,673
Bedford	360X7 -3018X1	Reliability	Circuit Tie	Bring a new 3 Phase feed into the center of New Boston from the East via the 360X7 by installing 18,500 ft of new 477 spacer cable, converting from 4 kV to 12 kV and installing a 5 MVA pad mounted step transformer.	#14 2016	\$2,289,000	\$30	1,932
Chocorua / Rochester	19W1 to 73W2	Reliability	Circuit Tie - Concpetual	Construct 13.5 miles of three phase line along Hwy 153 from Ballard Ridge Rd in East Wakefield to Hwy 25 in Effingham				
Derry	3128X - 365X	Reliability	Circuit Tie - Concpetual	Extend 3128X and 365X three-phase line along Pillsbury Rd. Londonderry to create circuit tie between 365X and 3128X4		\$861,000		
Derry	3133X	Reliability	Hit List	Convert Lowell Rd Windham Convert 12 kV area and remove step up transformers feeding developments		\$130,000	n/a	
Derry	3133X	Reliability	System Betterment	Lowell Rd Windham Conversion Convert 3200' of three phase and 12,280' of single phase from 12 kV to 34 kV to eliminate step down/step up URDs.	9	\$1,800,000	n/a	
Derry	3141X - 3141X1	Reliability	Circuit Tie	Create circuit tie within the 3141X circuit - from the 3141X1 tap to the 3141R1 recloser	7	\$1,000,000	\$13.50	2,300
Derry	3184X	Reliability	Obsolete Equipment	Convert 3.74 kV areas in Londonderry		\$1,782,000	n/a	
Derry	3184X	Reliability	Obsolete Equipment	Convert 3.74 kV to 34 kV		\$360,000	n/a	
Derry	32W4	Reliability	Obsolete Equipment	Fordway Extension Reconductor Reconductor 3200' of #2 copper with 1/0 spacer cable		\$592,000	n/a	

Proposed Reliability Projects (not funded in 2021 Capital Plan)

AWC	Circuit	Category	Project Type	Project Description	Hitlist Ranking	Cost Estimate	\$ / CMS	Customers Provided Backfeed - Circuit Ties
Derry	32W4	Reliability	Obsolete Equipment	Reconductor #2 copper operating at 19.92kV, Fordway Extension, Derry		\$325,000	n/a	
Epping	S/S	Reliability	4KV Conversion	Convert circuits out of Newmarket S/S and retire S/S Also creates tie between 377X2 and 3229	n/a	\$466,000	n/a	
Hooksett	19X5 / 388	Reliability	Obsolete Equipment	Replace Hampshire Plaza switchgear Eliminates 23 kV switchgear operating at 34 kV		TBD	n/a	
Hooksett	22W2 - 23W2 - 16W1	Reliability	Circuit Tie - Concpetual	Malvern St to Valley St to Hanover St tie - allows full backup between stations		\$352,000		
Hooksett	324X10-3750	Reliability	Circuit Tie - Concpetual	Create tie by converting main line on Charles Bancroft Highway from 12 kv to 34 kv (4 miles of circuit). The 3-1/0 ACSR will not be reconducted as presently proposed.		\$2,500,000		1,050
Hooksett	325X2 - 325X7	Reliability	Circuit Tie - Concpetual	Convert portion of So. Willow St to 34kv, relocate 325X2 recloser from ROW to Lingard St to create a tie between 325X2 and 325X7.		\$1,135,000		1,416
Hooksett	334X17	Reliability	Obsolete Equipment	334X17 Voltage Conversion 3.74/2.16 kV conversion, Pembroke	n/a	\$740,000	n/a	
Hooksett	3613-335X15	Reliability	Circuit Tie - Concpetual	Create tie by converting and reconductoring Main St Hooksett from 3.74 kv to 34 kv. Convert 45 sections.		\$675,000		2,686
Hooksett	5W1/5W2	Reliability	Obsolete Equipment	Merrimack 5W1/5W2 Conversion Allows retirement of Merrimack S/S	n/a	\$800,000	n/a	
Keene	313X2 - South Peterborough (313)	Reliability	Circuit Tie	Circuit Tie between 313X2 and South Peterborough SS along Hwy 202 and Hwy 101	223	\$500,000	\$18.31	452
Lancaster	348X3 - 351X	Reliability	Circuit Tie	Construct 29,250' spacer cable line along Rte 3 or Rte 115		\$4,680,000	\$8.06	2,400
Lancaster	355X	Reliability	Circuit Tie - Concpetual	Re-Utilize existing North Stratford 12kV tie to VEC at 34.5kV, overbuild the 36W1 with 1/0 SPCA to tie it directly with the 355X.	n/a	\$500,000	\$0.69	5,810
Lancaster	355X1	Reliability	CAIDI Improvement	Convert 1 mile along Lost Nation Rd and Cumberland Rd to 19.9. Increases fault current by removing stepdown/stepup	59	\$170,000	\$1.59	
Lancaster	355X1	Reliability	Circuit Tie	Swap and convert Cumberland St from 355X15 to 355X1, remove 355X15 off-road, and old river crossing. Lost Nation Rd steps from 19.9kV to 2.4kV for 1 mile, then steps from 2.4kV to 7.2kV. Fault current drops to 150A after the step up transformer. Convert the 2.4kV line to 19.9kV.	61	\$150,000	\$11.41	169

Proposed Reliability Projects (not funded in 2021 Capital Plan)

AWC	Circuit	Category	Project Type	Project Description	Hitlist Ranking	Cost Estimate	\$ / CMS	Customers Provided Backfeed - Circuit Ties
Lancaster	355X10	Reliability	Circuit Tie - Conceptual	Utilize existing tie to VEC to feed the 355X10		\$120,000		
Lancaster/ Berlin	355 - 3525X5	Reliability	Circuit Tie	Construct approximately 20 miles of 34 kV spacer cable line from Colebrook to Errol along Route 26 to tie the 355 to the 3525X5		\$10,000,000		843
Nashua	389	Reliability	Circuit Tie - Conceptual	Restore 389 circuit between Long Hill S/S and Hudson S/S by adding spacer circuit to existing structures from Long Hill S/S to Main Street, and converting 7.2 kV along Farmington Rd to Eastbrook.				
Nashua	314X4	Reliability	CAIDI Improvement	Transfer feed from Davisville Rd to Burns Hill Rd. Convert 3800 feet along Burns Hill Rd in Wilton.		\$403,000	n/a	
Nashua	3155X8	Reliability	Hit List	Convert 1.7 miles of 7.2 kV single phase line along Starch Mill and Old County Roads in Mason to transfer load from the 3155X2 to the 3155X8	31	\$1,007,000	\$5.77	
Nashua	3159X	Reliability	Reliability	Reconstruct along Bates Rd in Merrimack to move customers between two feeds on the circuit. Breaks a block of 790 customers into two smaller groups		\$108,000	n/a	
Nashua	3175X1 - 383X3	Reliability	Circuit Tie	Convert and add phases along Highland Street to Route 102		\$357,000	\$9.38	860
Nashua	3177X1 - 3154X2	Reliability	Circuit Tie - Conceptual	Convert and add phases along Main Dunstable Rd, Nashua to create circuit tie between 3177X1 and 3154X2.		\$1,218,000		4,724
Nashua	3177X1 - 3177X3	Reliability	Circuit Tie	Add two phases Conant Road to create circuit tie to 3177X1.		\$944,800	\$9.01	3,896
Nashua	3217 / 3210	Reliability	4KV Conversion	Convert Pine Hill Rd to 7.2 kV Convert pocket of 2.4 to 7.2 kV	n/a	\$900,000	n/a	
Nashua	3217X	Reliability	CAIDI Improvement	Convert Pine Hill Rd Creates 7.2 kV tie beyond steps to allow backfeed		\$340,000	n/a	
Nashua	3445X-3159X	Reliability	Circuit Tie	Extend 3 phase 34.5 kV for 6500 feet.	#13-2017	\$489,000	\$10.35	1,090
Newport	316X1	Reliability	Circuit Tie	Create alternate feed to 316X1 circuit	1	\$7,000,000	\$7.00	3,447
Newport	44H1 / 42X4	Reliability	Coordination	Construct 34 kV overbuild through Newport Miscoordination/loading/sensitivity issues on the north side of Main St Newport step up transformer		\$1,700,000	n/a	
Newport	46W1 - 60W1	Reliability	Circuit Tie - Conceptual	Create circuit tie between 46W1 and 60W1 in Claremont	n/a	\$1,700,000		1,412

Proposed Reliability Projects (not funded in 2021 Capital Plan)

AWC	Circuit	Category	Project Type	Project Description	Hitlist Ranking	Cost Estimate	\$ / CMS	Customers Provided Backfeed - Circuit Ties
Newport	46W1 - 61W1	Reliability	Circuit Tie - Conceptual	Create circuit tie between 46W1 and 61W1 in Claremont. There is currently undersized wire limiting this tie.		\$468,000		
Newport	61W2	Reliability	System Betterment	Reconductor Maple Ave to eliminate circuit tie bottleneck. Reconductor 0.8 miles to allow Byrd Ave to carry River Road	n/a	\$468,000		
Portsmouth	3102X2 - 3102X5	Reliability	Circuit Tie - Conceptual	Convert/reconductor 2.25 miles along Elwyn & Mirona Road		\$1,300,000		5,515
Portsmouth	339X2 / 339X8	Reliability	Circuit Tie - Conceptual	Reconductor and convert along Spinnaker way in Portsmouth		\$399,000		
Rochester	392X/ 32X3	Reliability	Circuit Tie - Conceptual	Construct tie between 392X and 32X3		\$404,000		608
Rochester	392X1 - 392X2	Reliability	Circuit Tie - Conceptual	Construct line along Washington St and Estes Rd	15	\$1,192,000		1587
Rochester	41H1 / 41H2	Reliability	4KV Conversion	Convert Glenwood Ave Eliminates one circuit out of N Dover		\$480,000	n/a	
Tilton	10W1 - 70W1	Reliability	Circuit Tie - Conceptual	Reconductor 3,700' #2 Cu, N Main St, Laconia		\$480,000		
Tilton	12W1	Reliability	CAIDI Improvement	Relocate 1,600' of off road line to roadside Removes inaccessible line	126	\$170,000	n/a	
Tilton	70W2/2W2	Reliability	Circuit Tie - Conceptual	Reconductor 1100' of 2/0 copper along Stafford St in Laconia		\$130,000		

EVERSOURCE

Request for Initial Funding

Initial Funding Request Form

Date Prepared: 02/12/2021	Project Title: Ashland Reliability Project
Company/ies: Eversource NH	Project Number:
Organization: System Planning	Class(es) of Plant: D SS
Project Initiator: Matt Cosgro	Project Category: Stations - Transformers
Project Manager:	Project Type: Specific
Project Sponsor: Lavelle Freeman	Project Purpose: Reliability
Estimated in service date: 6/1/2024	If Transmission Project (check all that apply): PTF <input type="checkbox"/> Non-PTF <input checked="" type="checkbox"/>
Authorization Type: Initial Funding	
Total Request: \$250,000	

Project Need Statement:

Ashland Substation (115-34.5 kV bulk substation) is in violation of System Planning reliability criteria. Presently, not all load can be restored for loss of the transformer and a bus fault due to limited system capacity of neighboring stations to restore all permanently isolated load. Additionally, not all load can be restored for loss of a transformer contingencies at the neighboring Beebe River and Pemigewasset Substations.

The addition of a second transformer at Ashland creates a Transmission N-1 design violation (Transmission N-1 causes greater than a single Distribution N-1 situation), as a single radial tap supplies Ashland Substation.

Project Objectives:

Increase substation capacity at Ashland Substation by adding a second transformer. Also install series bus tie breakers to address a bus fault design violation once a bus tie breaker is installed. To address the Transmission design violation, bring in a second transmission line to the substation and construct a ring-bus transmission yard at Ashland.

Funding Request Explanation (total request, amount per task, deliverables):

Initial funding is to be utilized for development of solution alternatives, general arrangement and one-line drawings and estimating.

Preliminary Schedule:

Describe the project schedule and milestones in chronological order. Use the five milestones below as a starting point and add others that pertain to the project.

Milestone/Phase Name	Estimated Date
SDC Review of Preferred Solution	10/1/2021
30% Engineering Completion	5/1/2022
Full Funding request at EPAC	11/1/2022
Construction Start	12/1/2022
In Service Date	6/1/2024

EVERSOURCE

Request for Initial Funding

Initial Funding Request Form

Date Prepared: 02/12/2021	Project Title: Bridge Street Capacity Project
Company/ies: Eversource NH	Project Number:
Organization: System Planning	Class(es) of Plant: D SS
Project Initiator: Matt Cosgro	Project Category: Stations - Transformers
Project Manager:	Project Type: Specific
Project Sponsor: Lavelle Freeman	Project Purpose: Capacity & Reliability
Estimated in service date: 6/1/2026	If Transmission Project (check all that apply): PTF <input type="checkbox"/> Non-PTF <input checked="" type="checkbox"/>
Authorization Type: Initial Funding	
Total Request: \$250,000	

Project Need Statement:

Bridge Street Substation (115-34.5 kV bulk substation) is in violation of System Planning load and reliability criteria. Presently, peak load levels exceed the STE of the station. Additionally, not all load can be restored for a bus fault due to the respective number of substation feeders exceeding the number of load block transfers allowed for restoration switching. Bridge Street is also in violation of the design criteria for a transmission N-1 contingency causing greater than a single N-1 of the distribution system.

Project Objectives:

Increase substation capacity at Bridge Street Substation by replacing the existing two 44.8 MVA transformers with two 62.5 MVA transformers. Also install series bus tie breakers to address the bus fault design violation. A study should determine the possible transmission solution to utilize both the primary G192 the back-up K165 to ensure the transmission N-1 affecting only a single distribution N-1.

Funding Request Explanation (total request, amount per task, deliverables):

Initial funding is to be utilized for development of solution alternatives, general arrangement and one-line drawings and estimating.

Preliminary Schedule:

Describe the project schedule and milestones in chronological order. Use the five milestones below as a starting point and add others that pertain to the project.

Milestone/Phase Name	Estimated Date
SDC Review of Preferred Solution	4/1/2023
30% Engineering Completion	11/1/2023
Full Funding request at EPAC	5/1/2024
Construction Start	6/1/2024
In Service Date	6/1/2026

EVERSOURCE

Request for Initial Funding

Initial Funding Request Form

Date Prepared: 02/11/2021	Project Title: Chestnut Hill Reliability Project
Company/ies: Eversource NH	Project Number:
Organization: System Planning	Class(es) of Plant: D SS
Project Initiator: Matt Cosgro	Project Category: Stations - Transformers
Project Manager:	Project Type: Specific
Project Sponsor: Lavelle Freeman	Project Purpose: Reliability
Estimated in service date: 6/1/2025	If Transmission Project (check all that apply): PTF <input type="checkbox"/> Non-PTF <input type="checkbox"/>
Authorization Type: Initial Funding	
Total Request: \$250,000	

Project Need Statement:

Chestnut Hill Substation (115-34.5 kV bulk substation) is in violation of System Planning reliability criteria. Presently, not all load can be restored for loss of either Chestnut Hill transformer or a bus fault.

Project Objectives:

Address the design violation of loss of transformer or bus fault with the replacement of the existing transformers with two larger units and install series bus tie breakers and feeder breakers.

Funding Request Explanation (total request, amount per task, deliverables):

Initial funding is to be utilized for development of solution alternatives, general arrangement and one-line drawings and estimating.

Preliminary Schedule:

Describe the project schedule and milestones in chronological order. Use the five milestones below as a starting point and add others that pertain to the project.

Milestone/Phase Name	Estimated Date
SDC Review of Preferred Solution	4/1/2023
30% Engineering Completion	11/1/2023
Full Funding request at EPAC	5/1/2024
Construction Start	6/1/2024
In Service Date	6/1/2025

EVERSOURCE

Request for Initial Funding

Initial Funding Request Form

Date Prepared: 02/18/2021	Project Title: Derry Reliability Project
Company/ies: Eversource NH	Project Number:
Organization: System Planning	Class(es) of Plant: D SS
Project Initiator: Matt Cosgro	Project Category: Stations - GIS
Project Manager:	Project Type: Specific
Project Sponsor: Lavelle Freeman	Project Purpose: Reliability
Estimated in service date: 6/1/2024	If Transmission Project (check all that apply): PTF <input type="checkbox"/> Non-PTF <input type="checkbox"/>
Authorization Type: Initial Funding	
Total Request: \$250,000	

Project Need Statement:

Scobie Pond Substation (115-12.47 kV bulk substation) is in violation of System Planning reliability criteria. Presently, not all load can be restored for a bus fault or bus tie breaker failure due to distribution system capacity limitations.

Project Objectives:

Perform a study to identify what distribution system improvements (upgrades or additions) to the Derry area distribution system are required. Also install series bus tie breakers to address the bus fault design violation.

Funding Request Explanation (total request, amount per task, deliverables):

Initial funding is to be utilized for development of solution alternatives, general arrangement and one-line drawings and estimating.

Preliminary Schedule:

Describe the project schedule and milestones in chronological order. Use the five milestones below as a starting point and add others that pertain to the project.

Milestone/Phase Name	Estimated Date
SDC Review of Preferred Solution	4/1/2022
30% Engineering Completion	11/1/2022
Full Funding request at EPAC	5/1/2023
Construction Start	6/1/2023
In Service Date	6/1/2024

EVERSOURCE

Request for Initial Funding

Initial Funding Request Form

Date Prepared: 02/12/2021	Project Title: Garvins Reliability Project
Company/ies: Eversource NH	Project Number:
Organization: System Planning	Class(es) of Plant: D SS
Project Initiator: Matt Cosgro	Project Category: Stations - Circuit Breakers
Project Manager:	Project Type: Specific
Project Sponsor: Lavelle Freeman	Project Purpose: Reliability
Estimated in service date: 6/1/2024	If Transmission Project (check all that apply): PTF <input type="checkbox"/> Non-PTF <input type="checkbox"/>
Authorization Type: Initial Funding	
Total Request: \$250,000	

Project Need Statement:

Garvins Substation (115-34.5 kV bulk substation) is in violation of System Planning reliability criteria. Presently, not all load can be restored for a bus fault which clears all distribution feeders at the station, which exceeds the number of load block transfers allowed for restoration switching.

Project Objectives:

Address the design violation of a bus fault with the addition of series bus tie breakers.

Funding Request Explanation (total request, amount per task, deliverables):

Initial funding is to be utilized for development of solution alternatives, general arrangement and one-line drawings and estimating.

Preliminary Schedule:

Describe the project schedule and milestones in chronological order. Use the five milestones below as a starting point and add others that pertain to the project.

Milestone/Phase Name	Estimated Date
SDC Review of Preferred Solution	4/1/2022
30% Engineering Completion	11/1/2022
Full Funding request at EPAC	5/1/2023
Construction Start	6/1/2023
In Service Date	6/1/2024

EVERSOURCE

Request for Initial Funding

Initial Funding Request Form

Date Prepared: 02/12/2021	Project Title: Hudson Reliability Project
Company/ies: Eversource NH	Project Number:
Organization: System Planning	Class(es) of Plant: D SS
Project Initiator: Matt Cosgro	Project Category: Stations - Circuit Breakers
Project Manager:	Project Type: Specific
Project Sponsor: Lavelle Freeman	Project Purpose: Reliability
Estimated in service date: 6/1/2026	If Transmission Project (check all that apply): PTF <input type="checkbox"/> Non-PTF <input type="checkbox"/>
Authorization Type: Initial Funding	
Total Request: \$250,000	

Project Need Statement:

Hudson Substation (115-34.5 kV bulk substation) is in violation of System Planning reliability criteria. Presently, not all load can be restored for a bus fault due to the number of substation feeders exceeding the number of load block transfers allowed for restoration switching.

Project Objectives:

Address the design violation of a bus fault with the addition of series bus tie breakers.

Funding Request Explanation (total request, amount per task, deliverables):

Initial funding is to be utilized for development of solution alternatives, general arrangement and one-line drawings and estimating.

Preliminary Schedule:

Describe the project schedule and milestones in chronological order. Use the five milestones below as a starting point and add others that pertain to the project.

Milestone/Phase Name	Estimated Date
SDC Review of Preferred Solution	4/1/2024
30% Engineering Completion	11/1/2024
Full Funding request at EPAC	5/1/2025
Construction Start	6/1/2025
In Service Date	6/1/2026

EVERSOURCE

Request for Initial Funding

Initial Funding Request Form

Date Prepared: 02/12/2021	Project Title: Huse Road Capacity Project
Company/ies: Eversource NH	Project Number:
Organization: System Planning	Class(es) of Plant: D SS
Project Initiator: Matt Cosgro	Project Category: Stations - Transformers
Project Manager:	Project Type: Specific
Project Sponsor: Lavelle Freeman	Project Purpose: Capacity & Reliability
Estimated in service date: 6/1/2027	If Transmission Project (check all that apply): PTF <input type="checkbox"/> Non-PTF <input type="checkbox"/>
Authorization Type: Initial Funding	
Total Request: \$250,000	

Project Need Statement:

Huse Road Substation (115-34.5 kV bulk substation) is in violation of System Planning load and reliability criteria. Presently, peak load levels exceed the STE of the station. Additionally, not all load can be restored for a bus fault due to the respective number of substation feeders exceeding the number of load block transfers allowed for restoration switching.

Project Objectives:

Increase substation capacity at Huse Road Substation by replacing the existing 44.8 and 48 MVA transformers with two 62.5 MVA transformers. Also install series bus tie breakers to address the bus fault design violation.

Funding Request Explanation (total request, amount per task, deliverables):

Initial funding is to be utilized for development of solution alternatives, general arrangement and one-line drawings and estimating.

Preliminary Schedule:

Describe the project schedule and milestones in chronological order. Use the five milestones below as a starting point and add others that pertain to the project.

Milestone/Phase Name	Estimated Date
SDC Review of Preferred Solution	4/1/2024
30% Engineering Completion	11/1/2024
Full Funding request at EPAC	5/1/2025
Construction Start	6/1/2025
In Service Date	6/1/2027

EVERSOURCE

Request for Initial Funding

Initial Funding Request Form

Date Prepared: 02/12/2021	Project Title: Jackman Reliability Project
Company/ies: Eversource NH	Project Number:
Organization: System Planning	Class(es) of Plant: D SS
Project Initiator: Matt Cosgro	Project Category: Stations - Circuit Breakers
Project Manager:	Project Type: Specific
Project Sponsor: Lavelle Freeman	Project Purpose: Reliability
Estimated in service date: 6/1/2026	If Transmission Project (check all that apply): PTF <input type="checkbox"/> Non-PTF <input type="checkbox"/>
Authorization Type: Initial Funding	
Total Request: \$250,000	

Project Need Statement:

Jackman Substation (115-34.5 kV bulk substation) is in violation of System Planning reliability criteria. Presently, not all load can be restored for a bus fault due to the number of substation feeders exceeding the number of load block transfers allowed for restoration switching.

Project Objectives:

Address the design violation of a bus fault with the addition of series bus tie breakers.

Funding Request Explanation (total request, amount per task, deliverables):

Initial funding is to be utilized for development of solution alternatives, general arrangement and one-line drawings and estimating.

Preliminary Schedule:

Describe the project schedule and milestones in chronological order. Use the five milestones below as a starting point and add others that pertain to the project.

Milestone/Phase Name	Estimated Date
SDC Review of Preferred Solution	4/1/2024
30% Engineering Completion	11/1/2024
Full Funding request at EPAC	5/1/2025
Construction Start	6/1/2025
In Service Date	6/1/2026

EVERSOURCE

Request for Initial Funding

Initial Funding Request Form

Date Prepared: 02/12/2021	Project Title: Laconia Reliability Project
Company/ies: Eversource NH	Project Number:
Organization: System Planning	Class(es) of Plant: D SS
Project Initiator: Matt Cosgro	Project Category: Stations - Circuit Breakers
Project Manager:	Project Type: Specific
Project Sponsor: Lavelle Freeman	Project Purpose: Reliability
Estimated in service date: 12/31/2023	If Transmission Project (check all that apply): PTF <input type="checkbox"/> Non-PTF <input type="checkbox"/>
Authorization Type: Initial Funding	
Total Request: \$250,000	

Project Need Statement:

Laconia Substation (115-34.5 kV bulk substation) is in violation of System Planning reliability criteria. Presently, not all load can be restored for a bus fault due to the number of substation feeders exceeding the number of load block transfers allowed for restoration switching.

Project Objectives:

Address the design violation of a bus fault with the addition of series bus tie breakers.

Funding Request Explanation (total request, amount per task, deliverables):

Initial funding is to be utilized for development of solution alternatives, general arrangement and one-line drawings and estimating.

Preliminary Schedule:

Describe the project schedule and milestones in chronological order. Use the five milestones below as a starting point and add others that pertain to the project.

Milestone/Phase Name	Estimated Date
SDC Review of Preferred Solution	10/30/2021
30% Engineering Completion	5/30/2022
Full Funding request at EPAC	11/30/2022
Construction Start	12/31/2022
In Service Date	12/31/2023

EVERSOURCE

Request for Initial Funding

Initial Funding Request Form

Date Prepared: 02/11/2021	Project Title: Lawrence Road TX Breaker
Company/ies: Eversource NH	Project Number:
Organization: System Planning	Class(es) of Plant: D SS
Project Initiator: Matt Cosgro	Project Category: Stations - Circuit Breakers
Project Manager:	Project Type: Specific
Project Sponsor: Lavelle Freeman	Project Purpose: Reliability
Estimated in service date: 6/1/2024	If Transmission Project (check all that apply): PTF <input type="checkbox"/> Non-PTF <input type="checkbox"/>
Authorization Type: Initial Funding	
Total Request: \$250,000	

Project Need Statement:

Lawrence Road Substation (115-34.5 kV bulk substation) will be in violation of System Planning reliability criteria. Starting in 2021, for loss of the Lawrence Road transformer not all load can be restored.

Project Objectives:

Address the design violation of loss of transformer by installing a 34.5 kV transformer breaker, which allows use of the 34.5 kV distribution bus and express feeder lines from Hudson Substation. Operational benefits include not having to offload all of Lawrence Road Substation for transmission or transformer outages.

Funding Request Explanation (total request, amount per task, deliverables):

Initial funding is to be utilized for development of solution alternatives, general arrangement and one-line drawings and estimating.

Preliminary Schedule:

Describe the project schedule and milestones in chronological order. Use the five milestones below as a starting point and add others that pertain to the project.

Milestone/Phase Name	Estimated Date
SDC Review of Preferred Solution	4/1/2022
30% Engineering Completion	11/1/2022
Full Funding request at EPAC	5/1/2023
Construction Start	6/1/2023
In Service Date	6/1/2024

EVERSOURCE

Request for Initial Funding

Initial Funding Request Form

Date Prepared: 02/12/2021	Project Title: Long Hill Capacity Project
Company/ies: Eversource NH	Project Number:
Organization: System Planning	Class(es) of Plant: D SS
Project Initiator: Matt Cosgro	Project Category: Stations - Transformers
Project Manager:	Project Type: Specific
Project Sponsor: Lavelle Freeman	Project Purpose: Capacity & Reliability
Estimated in service date: 6/1/2027	If Transmission Project (check all that apply): PTF <input type="checkbox"/> Non-PTF <input type="checkbox"/>
Authorization Type: Initial Funding	
Total Request: \$250,000	

Project Need Statement:

Long Hill Substation (115-34.5 kV bulk substation) is in violation of System Planning load and reliability criteria. Presently, peak load levels exceed the STE of the station. Additionally, not all load can be restored for a bus fault due to limited system capacity. Long Hill is also in violation of the design criteria for a transmission N-1 contingency causing greater than a single N-1 of the distribution system.

Project Objectives:

Increase substation capacity at Long Hill Substation by replacing the existing two 44.8 MVA transformers with two 62.5 MVA transformers. A study should determine if larger transformers at Bridge Street Substation allow for full restoration of customer load for a Long Hill bus fault contingency. The installation of series bus tie breakers may be needed to address the bus fault design violation. The transmission N-1 design violation may be resolved with the transmission solution for the South Milford project. If a Long Hill to South Milford transmission line is not constructed, a study should determine the possible transmission solution.

Funding Request Explanation (total request, amount per task, deliverables):

Initial funding is to be utilized for development of solution alternatives, general arrangement and one-line drawings and estimating.

Preliminary Schedule:

Describe the project schedule and milestones in chronological order. Use the five milestones below as a starting point and add others that pertain to the project.

Milestone/Phase Name	Estimated Date
SDC Review of Preferred Solution	4/1/2025
30% Engineering Completion	11/1/2025
Full Funding request at EPAC	5/1/2026
Construction Start	6/1/2026
In Service Date	6/1/2027

EVERSOURCE

Request for Initial Funding

Initial Funding Request Form

Date Prepared: 02/11/2021	Project Title: Loudon Capacity Project
Company/ies: Eversource NH	Project Number:
Organization: System Planning	Class(es) of Plant: D SS
Project Initiator: Matt Cosgro	Project Category: Stations - Transformers
Project Manager:	Project Type: Specific
Project Sponsor: Lavelle Freeman	Project Purpose: Capacity
Estimated in service date: 6/1/2026	If Transmission Project (check all that apply): PTF <input type="checkbox"/> Non-PTF <input type="checkbox"/>
Authorization Type: Initial Funding	
Total Request: \$250,000	

Project Need Statement:

Loudon Substation (34.5-12.47 kV non-bulk substation) is presently in violation of System Planning capacity criteria. Loudon transformer 31W1 is forecasted to have loading exceed its nameplate rating in 2021. Loudon transformer 31W2 has had load levels exceed its nameplate rating in 2019 and 2020, and is forecasted to exceed its nameplate rating in 2021.

Project Objectives:

Increase base case capacity at Loudon Substation with the replacement of the existing 5.25 MVA and 3.36 MVA transformers with a 12.5 MVA unit.

Funding Request Explanation (total request, amount per task, deliverables):

Initial funding is to be utilized for development of solution alternatives, general arrangement and one-line drawings and estimating.

Preliminary Schedule:

Describe the project schedule and milestones in chronological order. Use the five milestones below as a starting point and add others that pertain to the project.

Milestone/Phase Name	Estimated Date
SDC Review of Preferred Solution	4/1/2023
30% Engineering Completion	11/1/2023
Full Funding request at EPAC	5/1/2024
Construction Start	6/1/2024
In Service Date	6/1/2026

EVERSOURCE

Request for Initial Funding

Initial Funding Request Form

Date Prepared: 02/12/2021	Project Title: Madbury Reliability Project
Company/ies: Eversource NH	Project Number:
Organization: System Planning	Class(es) of Plant: D SS
Project Initiator: Matt Cosgro	Project Category: Stations - Transformers
Project Manager:	Project Type: Specific
Project Sponsor: Lavelle Freeman	Project Purpose: Capacity & Reliability
Estimated in service date: 6/1/2025	If Transmission Project (check all that apply): PTF <input type="checkbox"/> Non-PTF <input type="checkbox"/>
Authorization Type: Initial Funding	
Total Request: \$250,000	

Project Need Statement:

Madbury Substation (115-34.5 kV bulk substation) is in violation of System Planning load and reliability criteria. Presently, peak load levels exceed the STE of the station. Additionally, not all load can be restored for a bus fault due to the number of substation feeders exceeding the number of load block transfers allowed for restoration switching and limited system capacity of neighboring stations to restore all permanently isolated load.

Project Objectives:

Increase substation capacity at Madbury Substation by replacing the two existing 44.8 MVA transformers with two 62.5 MVA transformers. Also install series bus tie breakers to address the bus fault design violation.

Funding Request Explanation (total request, amount per task, deliverables):

Initial funding is to be utilized for development of solution alternatives, general arrangement and one-line drawings and estimating.

Preliminary Schedule:

Describe the project schedule and milestones in chronological order. Use the five milestones below as a starting point and add others that pertain to the project.

Milestone/Phase Name	Estimated Date
SDC Review of Preferred Solution	4/1/2022
30% Engineering Completion	11/1/2022
Full Funding request at EPAC	5/1/2023
Construction Start	6/1/2023
In Service Date	6/1/2025

EVERSOURCE

Request for Initial Funding

Initial Funding Request Form

Date Prepared: 02/12/2021	Project Title: Manchester Area Reliability Project
Company/ies: Eversource NH	Project Number:
Organization: System Planning	Class(es) of Plant: D SS
Project Initiator: Matt Cosgro	Project Category: Stations - General
Project Manager:	Project Type: Specific
Project Sponsor: Lavelle Freeman	Project Purpose: Capacity & Reliability
Estimated in service date: 6/1/2027	If Transmission Project (check all that apply): PTF <input type="checkbox"/> Non-PTF <input type="checkbox"/>
Authorization Type: Initial Funding	
Total Request: \$250,000	

Project Need Statement:

Bedford, Eddy, and Pine Hill Substations (all 115-34.5 kV bulk substations) are in violation of System Planning reliability criteria. Presently, peak load levels at all three stations exceed their respective STE ratings. At all three noted substations and Rimmon Substation, not all load can be restored for a bus tie breaker failure due to the respective number of substation feeders exceeding the number of load block transfers allowed for restoration switching.

Project Objectives:

Increase substation capacity at select Manchester area substations with appropriate load transfers to reduce loading at all three substations below their STE ratings. Depending on final system configuration, series bus tie breakers may be required at some or all of the locations.

Funding Request Explanation (total request, amount per task, deliverables):

Initial funding is to be utilized for development of solution alternatives, general arrangement and one-line drawings and estimating.

Preliminary Schedule:

Describe the project schedule and milestones in chronological order. Use the five milestones below as a starting point and add others that pertain to the project.

Milestone/Phase Name	Estimated Date
SDC Review of Preferred Solution	4/1/2024
30% Engineering Completion	11/1/2024
Full Funding request at EPAC	5/1/2025
Construction Start	6/1/2025
In Service Date	6/1/2027

EVERSOURCE

Request for Initial Funding

Initial Funding Request Form

Date Prepared: 02/16/2021	Project Title: North Road Reliability Project
Company/ies: Eversource NH	Project Number:
Organization: System Planning	Class(es) of Plant: D SS
Project Initiator: Matt Cosgro	Project Category: Stations - Circuit Breakers
Project Manager:	Project Type: Specific
Project Sponsor: Lavelle Freeman	Project Purpose: Reliability
Estimated in service date: 6/1/2026	If Transmission Project (check all that apply): PTF <input type="checkbox"/> Non-PTF <input type="checkbox"/>
Authorization Type: Initial Funding	
Total Request: \$250,000	

Project Need Statement:

North Road Substation (115-34.5 kV bulk substation) is in violation of System Planning reliability criteria. Presently, not all load can be restored for a bus fault due to the permanent isolated load far exceeding the available capacity of the single circuit tie to another substation.

Project Objectives:

Address the design violation of a bus fault with the addition of series bus tie breakers.

Funding Request Explanation (total request, amount per task, deliverables):

Initial funding is to be utilized for development of solution alternatives, general arrangement and one-line drawings and estimating.

Preliminary Schedule:

Describe the project schedule and milestones in chronological order. Use the five milestones below as a starting point and add others that pertain to the project.

Milestone/Phase Name	Estimated Date
SDC Review of Preferred Solution	4/1/2024
30% Engineering Completion	11/1/2024
Full Funding request at EPAC	5/1/2025
Construction Start	6/1/2025
In Service Date	6/1/2026

EVERSOURCE

Request for Initial Funding

Initial Funding Request Form

Date Prepared: 02/23/2021	Project Title: Portsmouth 12 kV Reliability Project
Company/ies: Eversource NH	Project Number:
Organization: System Planning	Class(es) of Plant: D SS
Project Initiator: Matt Cosgro	Project Category: Stations - Transformers
Project Manager:	Project Type: Specific
Project Sponsor: Lavelle Freeman	Project Purpose: Reliability
Estimated in service date: 6/1/2025	If Transmission Project (check all that apply): PTF <input type="checkbox"/> Non-PTF <input type="checkbox"/>
Authorization Type: Initial Funding	
Total Request: \$250,000	

Project Need Statement:

Mill Pond Substation (115-12.47 kV bulk substation) is in violation of System Planning reliability criteria. Presently, not all load can be restored for contingent loss of the transformer nor a bus fault due to limited system capacity of the lines and neighboring stations to restore all permanently isolated load.

Project Objectives:

Increase substation capacity at neighboring Cutts Street Substation (34.5-12.47 kV non-bulk substation) by replacing the existing 4.5 MVA transformer with a new 12.5 MVA transformer. This also addresses condition concerns (ranked 2-Yellow by Substation Technical Engineering in March of 2020) with the Cutts Street transformer. Study possible upgrades to the 12.47 kV distribution system to utilize Cutts Street capacity.

Funding Request Explanation (total request, amount per task, deliverables):

Initial funding is to be utilized for development of solution alternatives, general arrangement and one-line drawings and estimating.

Preliminary Schedule:

Describe the project schedule and milestones in chronological order. Use the five milestones below as a starting point and add others that pertain to the project.

Milestone/Phase Name	Estimated Date
SDC Review of Preferred Solution	4/1/2022
30% Engineering Completion	11/1/2022
Full Funding request at EPAC	5/1/2023
Construction Start	6/1/2023
In Service Date	6/1/2025

EVERSOURCE

Request for Initial Funding

Initial Funding Request Form

Date Prepared: 02/23/2021	Project Title: Salmon Falls Capacity Project
Company/ies: Eversource NH	Project Number:
Organization: System Planning	Class(es) of Plant: D SS
Project Initiator: Matt Cosgro	Project Category: Stations - Transformers
Project Manager:	Project Type: Specific
Project Sponsor: Lavelle Freeman	Project Purpose: Capacity
Estimated in service date: 6/1/2024	If Transmission Project (check all that apply): PTF <input type="checkbox"/> Non-PTF <input type="checkbox"/>
Authorization Type: Initial Funding	
Total Request: \$250,000	

Project Need Statement:

Salmon Falls Substation (13.8-4.16 kV non-bulk substation) is in violation of System Planning loading criteria. Peak loading in 2019 and 2020 have exceeded nameplate capacity of the substation.

Project Objectives:

Increase substation capacity at Salmon Falls Substation by adding parallel overhead single-phase step transformers to the existing set of steps, doubling nameplate capacity from 1.5 MVA to 3.0 MVA.

Funding Request Explanation (total request, amount per task, deliverables):

Initial funding is to be utilized for development of solution alternatives, general arrangement and one-line drawings and estimating.

Preliminary Schedule:

Describe the project schedule and milestones in chronological order. Use the five milestones below as a starting point and add others that pertain to the project.

Milestone/Phase Name	Estimated Date
SDC Review of Preferred Solution	4/1/2022
30% Engineering Completion	11/1/2022
Full Funding request at EPAC	5/1/2023
Construction Start	6/1/2023
In Service Date	6/1/2024

EVERSOURCE

Request for Initial Funding

Initial Funding Request Form

Date Prepared: 01/28/2021	Project Title: South Milford Capacity Project
Company/ies: Eversource NH	Project Number: A20S19
Organization: System Planning	Class(es) of Plant: T SS, T Line, D SS, D Line
Project Initiator: Matt Cosgro	Project Category: Stations - Transformers
Project Manager:	Project Type: Specific
Project Sponsor: Lavelle Freeman	Project Purpose: Capacity & Reliability
Estimated in service date: 6/1/2024	If Transmission Project (check all that apply): PTF <input type="checkbox"/> Non-PTF <input checked="" type="checkbox"/>
Authorization Type: Initial Funding	
Total Request: \$250,000	

Project Need Statement:

South Milford Substation (115-34.5 kV bulk substation) is presently in violation of several System Planning capacity criteria. They include base loading exceeding 95% of nameplate, permanent isolated load following loss/failure of a transformer, bus section, and bus tie breaker, and feeder loading exceeding 90% of the normal rating of the conductor on the 314 line. With adding a second transformer to increase capacity, this results in a new System Planning design violation of a single transmission contingency event causing greater than a single distribution N-1 contingency event. The existing supply to South Milford is a radial 115 kV transmission line (W157).

Project Objectives:

Increase base case and contingent capacity at South Milford Substation with the replacement of the existing 44.8 MVA transformer with a 62.5 MVA unit and add a second 62.5 MVA transformer to increase LCC. Address feeder loading with the construction of a new 34.5 kV feeder to offload the 314 line. Constructing another transmission line into South Milford provides a second transmission supply, addressing the design violation.

Funding Request Explanation (total request, amount per task, deliverables):

Initial funding is to be utilized for development of general arrangement and one-line drawings and estimating. Estimates to be developed for reworking or building new at South Milford, estimating three new feeder routes, and the construction of a new transmission line for three possible routes and a transmission system study to identify necessary system upgrades. From these estimates, the Distribution System Planning study can be completed with appropriate analysis comparing all solution options to identify preferred and alternatives.

EVERSOURCE
Request for Initial Funding**Preliminary Schedule:**

Describe the project schedule and milestones in chronological order. Use the five milestones below as a starting point and add others that pertain to the project.

Milestone/Phase Name	Estimated Date
SDC Review of Preferred Solution	10/1/2021
30% Engineering Completion	11/1/2021
Full Funding request at EPAC	11/1/2022
Construction Start	12/1/2022
In Service Date	6/1/2024

EVERSOURCE

Request for Initial Funding

Initial Funding Request Form

Date Prepared: 02/18/2021	Project Title: Webster Reliability Project
Company/ies: Eversource NH	Project Number:
Organization: System Planning	Class(es) of Plant: T SS
Project Initiator: Matt Cosgro	Project Category: Stations - General
Project Manager:	Project Type: Specific
Project Sponsor: Lavelle Freeman	Project Purpose: Reliability
Estimated in service date: 6/1/2025	If Transmission Project (check all that apply): PTF <input checked="" type="checkbox"/> Non-PTF <input type="checkbox"/>
Authorization Type: Initial Funding	
Total Request: \$250,000	

Project Need Statement:

Webster Substation (115-34.5 kV bulk substation) is in violation of System Planning reliability criteria. Current design of the substation violates the design criteria of a single transmission N-1 contingency causing greater than a single distribution N-1 contingency. Loss of 115 kV bus tie breaker BT40 causes a permanent outage to both transformers at Webster as well as both transformers at Laconia Substation (supplied by the L176 and J125 lines).

Project Objectives:

The reconfiguration or installation of additional equipment at Webster substation will need to be studied to determine the optimal solution to address the Transmission N-1 violation.

Funding Request Explanation (total request, amount per task, deliverables):

Initial funding is to be utilized for development of solution alternatives, general arrangement and one-line drawings and estimating.

Preliminary Schedule:

Describe the project schedule and milestones in chronological order. Use the five milestones below as a starting point and add others that pertain to the project.

Milestone/Phase Name	Estimated Date
SDC Review of Preferred Solution	4/1/2022
30% Engineering Completion	11/1/2022
Full Funding request at EPAC	5/1/2023
Construction Start	6/1/2023
In Service Date	6/1/2025



Solution Selection Form

Date Prepared: 07/14/2020	Project Title: Rebuild White Lake SS
Company/ies: Eversource NH	Project ID Number: A18N03 (D SS) and T1419A (T SS)
Organization: Substation Design Engineering	Class(es) of Plant: Other
Project Initiator: Jonathan Bouchard	Project Category: Stations - Reconfiguration
Project Manager: Tim Kelley	Project Type: Specific
Project Sponsor: Paul Melzen	Project Purpose: Replace obsolete equipment and eliminate issues in the substation as a result of generation divestiture.
Estimated in service date: 6/1/23	
Facility Type (check all that apply): <input type="checkbox"/> BPS <input checked="" type="checkbox"/> BES <input checked="" type="checkbox"/> PTF <input type="checkbox"/> non-PTF <input type="checkbox"/> CIP <input checked="" type="checkbox"/> Distribution	

Project Need Statement

This project is required to address aging equipment and solving issues that are a result of the generation divestiture.

White Lake SS became a two transformer 115-34.5kV substation in the mid-1950s when a 115kV line (B-112) was constructed as a source to the area. A combustion turbine (CT) generator was added to the substation in 1968 to provide black start capability to the system. The White Lake CT was sold in 2018. Attached is the One-Line Diagram D-7801

The transformers, electromechanical relays and oil circuit breakers (OCB) are aging and much of this equipment is targeted to be replaced. This equipment includes:

1. Transformers:

<u>Equipment</u>	<u>Age (yrs)</u>	<u>Condition Assessment</u>
TB82	57	Priority 2
TB76	56	Priority 3

The following are the description of the Condition Assessment priority ratings from SS Technical:

- Priority 1: Condition is acceptable, normal operation
- Priority 2: Needs repair or a rollout of life extending measures
- Priority 3: Plan replacement or major repair

The Transformer TB82 assessment concerns are primarily with the Dissolved Gas Analysis (DGA). The DGA history of TB82 shows evidence of an internal fault within the last ten years. However, the key fault gasses that are above the alarm level represent an equilibrium as they have not shown any significant rate of change over the last 5 years. The CO₂ levels however are high and have steadily increased over the last 5 years. Indicating the presence of thermal overheating of the insulation paper which could lead to paper degradation.

The Transformer TB76 assessments are primarily with the Fluid Quality. The fluid quality test data over the past several years in the main tank and LTC show an increase of polar contaminants or excessive moisture with in the oil. This is interpolated from the very low



dielectric breakdown voltage at 1mm test gap. The fluid quality results are indicating oil deterioration.

2. Circuit Breakers: There has been a focus on removing OCBs from the Eversource system. The two oldest 34.5kV OCB on the Eversource NH system are at White Lake SS. This equipment has been recommended for replacement for various reasons including:

- There is a need to remove all circuit breakers from the system which break fault current utilizing an oil insulating medium.
- Several are unique and old breakers that no longer have spare parts and are difficult to maintain.

<u>Equipment</u>	<u>Age (yrs)</u>	<u>Priority (1)</u>
OCB TB82	69	7
OCB 333	70	11
OCB 3116	64	18
OCB TB76	64	36
OCB 347	54	47

(1) Oil Circuit Breaker (OCB) priority is based on a current list of 84 OCB scheduled to retire over the next 9 years as identified in the program A19X36.

3. Electromechanical Relays: A program is being established to replace electromechanical relays with numerical relays. Numerical relays provide setting flexibility, instantaneous reset for setting coordination, and event/oscillography records. Numerical relays have remote connection capability for immediate retrieval of event records and targets for analysis and troubleshooting. Numerical relays have software and hardware SCADA alarm capabilities. A numerical relay offers multiple protection and metering functions in contrast to single function electromechanical relays. Note that the Transmission relays are microprocessor based since they were replaced when the 115kV breakers were replaced and capacitor banks were added a few years ago along with a separate Transmission control house.

4. Generation Divestiture.

Eversource owned the CT at White Lake SS as part of the generation fleet until it was sold in 2018 as a part of generation divestiture. As a part of the sale the southern part of the SS yard was subdivided and sold. This includes the SS driveway, fuel storage, CT equipment, and the Distribution Control House. See White Lake Easement Plan, attached. The sale of the property was allowed partly because it was known that there was a near term project to rebuild the substation in order to increase capacity and address aging equipment. In the short term there have been some difficulties sharing the driveway and access to control houses, primarily with snow management during the winter. Jersey barriers have been installed to prevent generation from piling snow near Eversource equipment. This has increased access issues.



There are protection issues with the current configuration that were also intended to be addressed with the substation rebuild. The CT generator step up (GSU) transformer is directly to the 34.5kV bus. This exposes all customers fed from White Lake SS to a fault on the generation equipment. The 34.5kV breakers will be replaced with switchgear and the system will be protected from the generation facilities by feeding the CT facilities from a separate breaker position in the switchgear. The switchgear will include a distribution control enclosure and the protection and control of distribution equipment can be removed from the generation control house. The communication equipment is also in this building and will be relocated to the transmission or distribution control enclosure.

Project Objectives

This project is required to address aging equipment and solving issues that are a result of the generation divestiture.

Two (2) adjacent parcels north and west of the existing substation were procured in June 2020 to rebuild White Lake SS. This is a 5 acre parcel to the north and the 1 acre lot across Maple Street, adjacent to the Eversource ROW on the land plan below. Transmission lines will be rerouted to a 115kV breaker and a half transmission station which will feed two (2) 62.5MVA 115-34.5kV transformers. All 34.5kV circuit breakers will be replaced.



The Eversource equipment will be removed from the generation facilities and there will be proper relaying and control to protect Eversource customers from the generation interconnect. Attached is the White Lake SS Easement Plan showing the generation property with Eversource easement across it.



Alternatives Considered with Cost Estimates:

Non-wires alternatives (NWA) are not suitable options for this project due to no NWA being capable of addressing the condition issues with both transformers, electromechanical relays, aged oil circuit breakers, and substation access.

It should be noted that the outage impact for each alternative is for reference only and intended to be used to compare construction difficulty. Restrictions identified during the detailed design and construction may force additional and longer outages.

Alternative 1: This is the preferred alternative

Description

Rebuild the White Lake SS to the north of the existing substation. The new substation yard will include a 115kV Ring Bus configuration, two 115kV capacitor banks, two 62.5MVA 115-34.5kV transformers, 34.5kV Double Bus Bar Switchgear, and 34.5kV capacitor banks. A new transmission control house will be constructed. The 34.5kV switchgear will include a relay and control enclosure for distribution equipment.

Estimated Cost

<u>Construction Phase</u>	<u>Outage Impacts</u>
Construct new 115-34.5kV substation	No outages
Construct a tap to the B112 115kV line to energize the new substation	Two day outage to the B112 line
Energize new SS, test & commission	No outage
Remove transformer TB82, 115kV capacitor bank J1166, Line 3181 bay position and breaker, Bus 3 and steel structure.	No outage
Construct manhole and ductbank system from the new substation to the existing 34.5kV bus structure.	No outage
Re-terminate Line 3181 at new riser structure	No outage using circuit tie
Re-terminate Line 3116 at new riser structure	No outage using circuit tie
Re-terminate Line 3218 at new riser structure	No outage using circuit tie
Remove 34.5kV Capacitor bank C18	No outage
Construct new riser to feed Bus 1	No outage
Deenergize Bus 1 and Bus 2 and Transformer TB76. Remove 34.5kV Bus 2 structures and reconfigure feed to the Bus 1 including a meter for the CT.	One week outage to the CT
Re-terminate Line 346 at new riser structure	No outage using circuit tie
Reroute Y138 115kV line to new SS	One week outage of Y138
Disconnect B112 115kV line from old SS and rebuild 1-2 structures as required.	One week outage of B112
Remove all equipment and 115kV structures from the existing yard and control houses.	No outage

Risks

1. Siting and permitting risks. While this is adjacent to an existing substation, there are several residences in the area.



- The removal of equipment has some environmental risk. The equipment in the distribution control house may contain asbestos. Soil remediation of the brownfield site is required.

Pros

- The majority of the construction is on a greenfield site.
- Limited outages are required.
- The 34.5kV switchgear will limit exposure to animal outages.

Cons

- 115kV line outages are required to tie into the new substation. There will be periods when both 115kV lines will need to operate radially.

Alternative 2: This is NOT the preferred alternative

Description

Rebuild the White Lake SS to the north of the existing substation. The new substation yard will include a 115kV Ring Bus configuration, and two 62.5MVA 115-34.5kV transformers. A new transmission control house will be constructed. The existing 34.5kV circuit breakers will be replaced in the existing locations. Relay and controls will be replaced and the existing transmission control house will become the relay and control enclosure for distribution equipment. Some reconfiguration of the 34.5kV circuits and bus will be required to separate Eversource customers from the GSU for the generation.

Estimated Cost

Construction Phase

Construct new 115-34.5kV substation
Construct a tap to the B112 115kV line to energize the new substation
Energize new SS, test & commission
Remove transformer TB82, and 115kV capacitors
Replace breaker TB82
Refeed Bus 3 from the new transformer TX82
Reroute Y138 115kV line to new SS
Remove transformer TB76, breaker B1120, 115kV capacitors
Disconnect B112 115kV line from old SS and rebuild 1-2 structures as required.
Replace breaker TB76
Refeed Bus 2 from the new transformer TX76
Add a new bay position to Bus 3
Refeed Line 346 from Bus 3, add 34.5kV Capacitor Bank
Refeed generation with reconfiguration of Bus 1, add circuit breaker, add metering
Replace remaining line breakers 3181, 3116, 3218
Replace Capacitor bank switch C18

Outage Impacts

No outages
Two day outage to the B112 line
No outage
No outage
No outage
No outage
One week outage of Y138
No outage
One week outage of B112
No outage
No outage
No outage
No outage using circuit tie
One week outage to the CT
No outage using circuit tie
No outage using circuit tie



Remove distribution equipment from the generation control house. No outage

Risks

1. Siting and permitting risks. While this is adjacent to an existing substation, there are several residences in the area.
2. The removal of equipment has some environmental risk. The equipment in the distribution control house may contain asbestos. Soil remediation of the brownfield site is required.

Pros

1. This utilizes existing steel and foundations in the existing yard.

Cons

1. Yard congestion issues with generation will remain. The generation property is close to the 34.5kV capacitor bank and transformer lead structures currently being protected by jersey barriers. There will be no fenced barrier between distribution and generation assets.
2. 34.5kV bus structures and foundations are 60+ years old and will remain.
3. The 34.5kV open air construction is more vulnerable to animal outages.
4. 115kV line outages are required to tie into the new substation. There will be periods when both 115kV lines will need to operate radially.

Alternative 3: This is NOT the preferred alternative

Description

Rebuild the White Lake SS to the north of the existing substation. The new substation yard will include a 115kV Ring Bus configuration, two 115kV capacitor banks, two 62.5MVA 115-34.5kV transformers, open air 34.5kV construction with breakers and capacitor banks. A new shared transmission and distribution control house will be constructed.

Estimated Cost

<u>Construction Phase</u>	<u>Outage Impacts</u>
Construct new 115-34.5kV substation	No outages
Construct a tap to the B112 115kV line to energize the new substation	Two day outage to the B112 line
Energize new SS, test & commission	No outage
Remove transformer TB82, 115kV capacitor bank J1166, Line 3181 bay position and breaker, Bus 3 and steel structure.	No outage
Re-terminate Line 3181 to new breaker position.	No outage using circuit tie
Re-terminate Line 3116 to new breaker position	No outage using circuit tie
Re-terminate Line 3218 to new breaker position	No outage using circuit tie
Remove 34.5kV Capacitor bank C18	No outage
Deenergize Bus 1 and Bus 2 and Transformer TB76. Remove 34.5kV Bus 2 structures and reconfigure feed to the Bus 1 including a meter for the CT.	One week outage to the CT



Re-terminate Line 346 to new breaker position	No outage using circuit tie
Reroute Y138 115kV line to new SS	One week outage of Y138
Disconnect B112 115kV line from old SS and rebuild 1-2 structures as required.	One week outage of B112
Remove all equipment and 115kV structures from the existing yard and control houses.	No outage

Risks

1. Siting and permitting risks. While this is adjacent to an existing substation, there are several residences in the area.
2. The removal of equipment has some environmental risk. The equipment in the control house may contain asbestos. Soil remediation of the brownfield site is required.

Pros

Cons

1. Open air construction is more vulnerable to animal outages than switchgear. Switchgear is the preferred current construction standard.
2. 115kV line outages are required to tie into the new substation. There will be periods when both 115kV lines will need to operate radially.

Alternative 4: This is NOT the preferred alternative

Description

Rebuild the 34kV White Lake SS to the north of the existing substation. The new substation yard will include a 115kV two circuit switcher, two 62.5MVA 115-34.5kV transformers, 34.5kV double bus bar Switchgear, construction with breakers and capacitor banks.

Estimated Cost

<u>Construction Phase</u>	<u>Outage Impacts</u>
Construct new 115-34.5kV substation	No outages
Construct a tap to the 115kV Bus #2 to energize the new substation	Two day outage
Construct a tap to the 115kV Bus #1 to energize the new substation	Two day outage
Energize new SS, test & commission	No outage
Remove transformer TB82, 115kV capacitor bank J1166, Line 3181 bay position and breaker, Bus 3 and steel structure.	No outage
Re-terminate Line 3181 to new breaker position.	No outage using circuit tie
Re-terminate Line 3116 to new breaker position	No outage using circuit tie
Re-terminate Line 3218 to new breaker position	No outage using circuit tie
Remove 34.5kV Capacitor bank C18	No outage
Deenergize Bus 1 and Bus 2 and Transformer TB76. Remove 34.5kV Bus 2	One week outage to the CT



structures and reconfigure feed to the Bus 1 including a meter for the CT.

Re-terminate Line 346 to new breaker position

No outage using circuit tie

Terminate Line to White Lake Combustion Turbine to new breaker position

No outage using circuit tie

Risks

1. Siting and permitting risks. While this is adjacent to an existing substation, there are several residences in the area.
2. The removal of equipment has some environmental risk. The equipment in the control house may contain asbestos. Soil remediation of the brownfield site is required.

Pros

1. Reutilize existing 115kV yard.
2. Eliminate the new to reroute the 115kV line. No Line outages

Cons

1. Yard congestion issues with generation will remain. Limited capacity to expand on the 115kV yard. Tight yard.

Project Scope (Preferred Solution)

Rebuild the White Lake SS to the north of the existing substation. The new substation yard will include a 115kV Ring Bus configuration, two 115kV capacitor banks, two 62.5MVA 115-34.5kV transformers, 34.5kV Double Bus Bar switchgear, and 34.5kV capacitor banks. A new transmission control house will be constructed. The 34.5kV switchgear house will include a relay and control enclosure for distribution equipment.

Transmission line and Distribution line descriptions.

Major Material to be added/removed.

A. Major Equipment to be included in the design:

1. Substation design will include:
 - i. Eight (8) 3000A, 115kV Eversource Standard circuit breakers (Eversource plans to install ABB 115kV breakers which employ plug and play features. Vendor will make provisions to utilize these "plug and play" features between the breaker and control building.)
 - ii. Eighteen (18) 2000A, 115kV manual operated disconnect switches
 - iii. Two (2) 2000A, 115kV motor operated disconnect switches with high speed interrupter for 115kV lines
 - iv. Twenty-One (24) 96kV surge arresters
 - v. Six (6) 30kV surge arresters
 - vi. Fifteen (15) 115kV CCVTs
 - vii. Twelve (12) RIO Boxes
 - viii. Two (2) 2000A, 34kV circuit switchers
 - ix. Two (2) 62.5 MVA 115 / 34.5 kV power transformers



- x. Two (2) 5.4 MVAR 34.5 kV Capacitor Banks
- xi. One (1) Metal clad Double Bus Bar Switchgear
 - a. Thirty-Six (38) Switchgear Cubicles 34.4kV, 2000Amp ratings
 - b. Ten (10) 34.5kV, 1200A Breaker
 - c. Ten (10) 34.5kV, 2000A Breaker
 - d. One Hundred and Eight (108) 34.5kV, 1200:1 CT's
 - e. Seventy-two (72) 34.5kV, 2000:1 CT's
 - f. Twenty-Five (25) 34.5kV, Single Phase Bus PTs
 - g. Two (2) 34.5kV, 2000A, Group Ordered Disconnect Switches
 - h. Six (6) 34.5kV, 600A, Group Ordered Disconnect Switches
 - i. Four (4) 34.5kV, Fused Group Ordered Disconnect Switches for Bus PT's
 - j. Two (2) 34.5kV, Fused Group Ordered Disconnect Switches for Station Service
 - k. Two (2) 34.5kV, 2000Amp, Over Head Bus Duct
- xii. Ten (10) 34.5kV Riser Structure.
- xiii. Two (2) Pad mount Station Service Transformers, 34.5 kV - 120/208V
- xiv. Seven (7) 34.5 kV manual disconnect switches for mobile substations
- xv. One (1) Outfitted, preassembled control building

2. Site design will include:

3. Civil design will include:

- i. Substation yard security fencing (by Site Design Consultant)
- ii. All structures as required for the site design such as drainage and retaining walls (by Site Design Consultant)
- iii. Steel structures and concrete foundations as required to support all electrical equipment
- iv. Concrete foundations as required for equipment enclosures
- v. Secondary oil containment system (tie-in to system discharge location determined by Site Design Consultant)
- vi. Infrastructure as required for providing bathroom facilities in the Control Building (tie-in to facilities designed by Site Design Consultant)

4. P&C design will include:

- i. Cabinet #P1- 61850 comm
- ii. Cabinet #P2- 61850 HMI
- iii. Cabinet #P3- 87/LP-Q166 (SEL 411L), 50/BFP-662(SEL 451),50/FP-9866(SEL 451), Test Switches and auxiliary devices.



- iv. Cabinet #P4- 87/LP-T198(SEL 411L), 50BFP-981(SEL451)
- v. Cabinet #P5- 21Z/LP-I135N (SEL 311C), 50/BFP-352(SEL 451), 50/BF-4035(SEL 451), Test switches and auxiliary devices.
- vi. Cabinet# P6- 21Z/LP-B40 (SEL 421), 50/BFP-401(SEL 451) Test switches and auxiliary devices.
- vii. Cabinet# P7- 21X/LP-B40(SEL 421), 50/BFP-9980(SEL 451), 50/BFP-802(SEL 451) Test switches and auxiliary devices.
- viii. Cabinet# P8- Primary Comm, SEL clock, Eng. Access equipment.
- ix. Cabinet# P9- 87/B1P-115(SEL 587Z), 87/B2P-115(SEL 587Z), Test switches and auxiliary devices.
- x. Cabinet #S1- 61850 comm
- xi. Cabinet #S2- 61850 HMI
- xii. Cabinet #S3- 87/LS-Q166 (SEL 311L), 50/BFS-662(SEL 451),50/FS-9866(SEL 451), Test Switches and auxiliary devices.
- xiii. Cabinet #S4- 87/LS-T198(SEL 411L), 50BFS-981(SEL451)
- xiv. Cabinet #S5- 21Z/LS-I135N (SEL 311C), 50/BFS-352(SEL 451), 50/BFS-4035(SEL 451), Test switches and auxiliary devices.
- xv. Cabinet#S6- 21Z/LS-B40 (SEL 311C), 50/BFS-401(SEL 451) Test switches and auxiliary devices.
- xvi. Cabinet# S7- 21X/LS-B40(SEL 311C1), 50/BFS-9980(SEL 451), 50/BFS-802(SEL 451) Test switches and auxiliary devices.
- xvii. Cabinet# S8- Secondary Comm, SEL clock, Eng. Access equipment.
- xviii. Cabinet# S9- 87/B1S-115(SEL 387), 87/B2S-115(SEL 387Z), Test switches and auxiliary devices.
- xix. Synchronizing Panel controlled by 61850.
- xx. RIO Cabinet- 662. RIO- P/662(SEL 2411), RIO-S662 (SEL-2411)
- xxi. RIO Cabinet- 9866. RIO- P/9866(SEL 2411), RIO-S/98666 (SEL-2411)
- xxii. RIO Cabinet- 981. RIO- P/981(SEL 2411), RIO-S/981 (SEL-2411)
- xxiii. RIO Cabinet- 166J1. RIO- P/166J1(SEL 2411), RIO-S/166J1 (SEL-2411)
- xxiv. RIO Cabinet- 198J1. RIO- P/198J1SEL 2411), RIO-S/198J1 (SEL-2411)
- xxv. RIO Cabinet- 352. RIO- P/352(SEL 2411), RIO-S/352 (SEL-2411)
- xxvi. RIO Cabinet-8035. RIO- P8035(SEL 2411), RIO-S/8035 (SEL-2411)
- xxvii. RIO Cabinet- 801. RIO- P/8011(SEL 2411), RIO-S/8011 (SEL-2411)
- xxviii. RIO Cabinet- 135NJ1. RIO- P/135NJ1(SEL 2411), RIO-S/135NJ1 (SEL-2411)



- xxix. RIO Cabinet- 802. RIO- P/802(SEL 2411), RIO-S/802(SEL-2411)
- xxx. RIO Cabinet- 9980. RIO- P/9980(SEL 2411), RIO-S/9980 (SEL-2411)

5. Telecom design will include:

- i. One (1) SEL-ICON SONET multiplexer and associated modules
- ii. Two (2) GE T1MUX shelves and channel cards (*If required, one in primary and one in secondary communication racks)
- iii. Four (4) Century FTS-700 S/TM Fiber Panels
- iv. Four (4) Ortonics OR-MM6706 communication racks (2 in Switchgear and 2 in Trans. Control House)
- v. Eight (8) Norantel 130V DC distribution panels (two in each of the communication racks)

6. IT/NCS:

- i. One (1) Cisco CGR 2010 Router
- ii. One (1) Cisco IE4010 Switch
- iii. One (1) Wireless Access Point
- iv. One (1) IP Phone

7. Transmission Line Engineering design will include:

- i. Install up to twelve (12) new weathering light duty steel structures on the Q166, T198, 3235, and 382 lines as required to redirect them onto the new substation steel.
- ii. Install new ACSR or ACSS conductor on all lines to match existing size or larger.
- iii. Install splice can on T198 Line to allow ADSS to be brought into the new substation.
- iv. Install splice can on Q166 Line to allow OPGW to be brought into new substation. New OPGW will be terminated on S/S steel.
- v. Install splice can on I135N Line to allow ADSS to be brought into the new substation.

8. Distribution Line Engineering design will include: Manholes, ductbank, riser structures.

B. Major Electrical Equipment to be Removed (Retirement of Existing Substation).

1. Substation design will include:

- i. One (1) 1200A wave trap
- ii. Three (3) 1200A, 115kV circuit breakers
- iii. Fifteen (15) 115kV CCVTs
- iv. Twenty One (21) 96kV Surge Arresters
- v. Six (6) 1200A, 115kV gang operated disconnect switches



- vi. One (1) 1200A, 115kV bus tie disconnect switch
- vii. Three (3) 50 kVA, 115kV- 120/208V station service transformers
- viii. One (1) Fused Disconnect Switch 200 A Fused
- ix. Contents of Transmission Control House, Twenty (20) panels (The building will be repurposed by ES)
- x. Two (2) 115kV Motor operated disconnect switches
- xi. One (1) 12/15/20 MVA 115 / 34.5 kV power transformer
- xii. One (1) 15/20/28 MVA 115 / 34.5 kV power transformer
- xiii. Two (2) 34.5kV oil circuit breaker
- xiv. Three (3) 34.5kV vacuum circuit breaker
- xv. Six (6) 25kVA, station service transformers
- xvi. Two (2) Fused disconnect switches for the station service
- xvii. Thirteen (13) 34.5kV disconnect switches
- xviii. One (1) 5.4MVAR capacitor bank assembly to be relocated to new site
- xix. Five (5) 34.5kV Potential transformers (PTs)
- xx. One (1) Distribution Control House, removal (20'x20') w/ ten (10) panels

2. Civil design will include:

- i. All structures and foundations shall be completely removed.
- ii. Distribution Control House and foundation shall be completely removed
- iii. Precast cable trench runs, and all interior cables shall be removed.
- iv. Yard fencing layout shall be modified as necessary.
- v. Emergency generator and propane tanks next to T Control House shall remain.
- vi. HDR will prepare appropriate removal drawings to support the project permitting effort by the Site Design Consultant. Permitting Support may include: General Arrangement Plans & Elevations, Control Enclosure drawings (both T & D), lightning protection and lighting plan & elevations, potential sound mitigation features, and overhead line support structure plans & elevations may be required to support the permitting effort.

3. P&C design will include:

- i. Cabinet S06, RTU GE D20, Drawing 01902265
- ii. Cabinet S07, Qualitrol – Drawing 01902265,
- iii. Cabinet S08, S/S Comm Drawing 01902265
- iv. Cabinet's C01, C02, C03, C04 & Sync Panel, Drawing 019202301



- v. Cabinets' P01, P02, P03 & P04, Drawing 09202299
- vi. Cabinet's S01, S02, S03 & S04, Drawing 09202300

4. Telecom & IT design will include:

- i. Remove JMUX T1MUX
- ii. Remove Lucent 1665 DMXplore
- iii. Remove Cisco CGR 2010 Router
- iv. Remove Cisco Switch
- v. Dynastar 2000 FRAD

5. Transmission Line Engineering design will include:

- i. Remove up to twenty-two (22) weathering steel and wooden structures on the Q166, T198, 3235, 382 and 3120 lines.
- ii. Remove existing conductor, neutral, ADSS and OPGW on above lines.
- iii. Remove existing splice can on T198 Line outside of Monadnock S/S.
- iv. Remove splice can on Q166 Line outside of Monadnock S/S.

Preliminary Project Checklist (For the preferred solution)

Is a NX-9 required?	Yes
Is an ISO-NE PAC presentation required?	Yes
Is a PPA required?	Yes
Is a TCA Application Required?	Yes

Cost Estimate Backup Details

Provide backup details of conceptual grade cost estimates (-25%/+50%) for all appropriate alternatives (at least the preferred solution and leading alternative).

Attachments (maps, images, one-line diagrams, MS PowerPoint presentations, MS Excel cost estimate files, etc.)



Solution Selection Form

Date Prepared: 3/17/2021	Project Title: Cocheco Street S/S Rebuild
Company: Eversource NH	Project ID Numbers: T1401A: Cocheco St S/S A18E04: D SS A19E47: D Line
Organization: System Planning	Class(es) of Plant: T&D Substation and Line
Project Initiator: Matt Cosgro	Project Category: Reliability
Project Manager: Matt Cosgro	Project Type: Specific
Project Sponsor: Lavelle Freeman	Project Purpose: Address substation reliability and asset condition.
Estimated in service date: 6/1/2024	If Transmission Project: PTF? Yes

Project Need Statement

The 2020 New Hampshire forecast for 2021 for the two 115-34.5 kV 44.8 MVA Cocheco St. (Dover) transformers (TB22 and TB55) is 80.9 MW or 90.2% of nameplate rating. Historical load in 2020 reached 80.3 MW or 89.6% of nameplate rating. While load levels on the station presently are within the 95% of nameplate utilization threshold identified in the Distribution System Planning Guide, the historical and forecasted load levels exceed the short-term emergency (STE) rating of the station, which is 54.0 MVA.

The 34.5kV bus is constructed with a normally closed manual bus tie switch. This configuration results in loss of the entire substation load for a bus fault. Following restoration switching of a bus fault contingency, 40.5 MW of load is exposed to a permanent outage (11,700 customers). The Distribution System Planning Guide directs all load to be restored following this type of contingency.

The 115kV bus is a solid straight bus with line breakers. A 115kV bus outage results in a permanent outage to both distribution bulk transformers serving about 24,800 customers.

The existing control house is located across the street in a c.1905 former powerhouse building that is the site of a former manufactured gas plant and is currently shared with another tenant. As part of this project a new control house including all associated lighting, power, HVAC, security, etc., will be added within the substation fence.

A condition assessment was performed on the existing 34.5 and 115 kV equipment to determine if any equipment should be replaced based upon its condition. A list of equipment to be replaced or added is identified in the Project Scope section.

Project Objectives

Address all Distribution System Planning Guide violations. This includes adding transformer capacity to 1) increase substation STE capacity to meets peak load demands and 2) increase the LCC capacity of the substation such that for the loss of a bus section all load can be restored via the remaining transformer and available circuit ties. Rebuild Cocheco St substation to operate with normally open 34.5kV bus tie breakers and an automatic bus restoral (ABR) scheme.

Replace aging/obsolete substation and protection equipment to improve system performance while reducing maintenance costs and requirements.



Alternatives Considered with Cost Estimates:

Non-wires alternatives (NWAs) are not suitable solutions for this project as no NWA is capable of addressing the asset condition issues and station design not to current standards, including the solid straight bus T & D configuration, condition of the control house, electromechanical relays, and the aged oil circuit breaker. Additionally, any NWA would need to reduce the effective loading on the substation transformers by an additional 26 MW. This is 32% percent of the forecasted 2021 loading at the station and is likely infeasible given that energy efficiency and distributed generation are currently reducing load at the station by only 6.5% percent based on the 2018 CELT forecast for year 2020.

All alternatives include the following Transmission protection and control (P&C) upgrades and associated communications infrastructure. The existing SONET ring and associated fiber will be utilized to provide the services/circuits for this project:

- 1) M183 Protection:
 - a. Add second pilot scheme by converting primary system to POTT. Communication will be Jmux or Direct Fiber.
 - b. Add communications facilities at Madbury to support new communications channel.
 - c. Replace GE D60 at Madbury with SEL-421 relay to match new relay at Cocheco.
- 2) R169 Protection
 - a. Convert primary line protection from Powerline Carrier to Fiber.
 - b. Add communications facilities at Three Rivers to support new channel.
 - c. Remove line trap and carrier facilities at Three Rivers.
 - d. Replace GE D60 at Three Rivers with SEL-421 relay to match new relay at Cocheco.
- 3) Install breaker failure transfer trip on M183 line. Communication will be Jmux or Direct Fiber using Inven transceiver. Will eliminate the need to rely on Dover Zone 3 to cover L175 faults with a stuck 7583 breaker. Direct transfer trip will be faster than Zone 3 and while this is not a firm system requirement, it is the recent practice to take advantage of existing fiber to implement breaker failure transfer trip.
 - a. Install matching Inven transceiver at Madbury

All alternatives utilize the company standard 62.5 MVA top nameplate rated transformers. (LTE = 79 MVA, STE = 93 MVA typical)

New or different elements in each alternative description have been underlined.

Alternative 1 (This option is **no longer recommended**):

Distribution: Construct a greenfield distribution yard (61850) with two 62.5 MVA transformers, high side circuit switcher, 34.5kV switchgear with series bus tie breakers, two 7.2 MVAR capacitor banks, and new control house (for T & D).

Transmission: Construct a greenfield 115kV substation (61850), breaker and one-half configuration with four bays. Station will be constructed as a four breaker ring initially with expansion capability to a breaker and one-half with six bays.

An updated estimate for Alternative 1 is currently in development.

Cost Estimate: \$TBD million Total

Distribution: \$TBD million Substation \$TBD million Line

Transmission: \$TBD million Substation \$TBD million Line

Positives/Benefits:

- o A bus fault or stuck line breaker will not result in loss of both transformers.
- o Substation can be constructed, tested, and commissioned prior to cutovers from old station. This minimizes testing and commissioning costs and significantly reduces outage planning and impacts to reliability during construction.



- Both T&D yards will be 61850 design which is the company greenfield design standard providing long term operational and reliability benefits.
- This option provides the capability of a 115kV bay position to terminate a future Cocheco to Eastport 115kV Line.
- Moves S/S further back from road and water front (may be preferred during siting)
- Switchgear is more resistant to animal contact while cost competitive with open air design.

Challenges/Risks:

- Greenfield construction will require greater siting/permitting. The greenfield site will be slightly closer to a residential area.

Alternative 2: (This option is the new preferred alternative)

Distribution: Construct a greenfield distribution yard (61850) with two 62.5 MVA transformers, high side circuit switcher, 34.5kV double-bus switchgear with normally open bus-tie breakers, two 7.2 MVAR capacitor banks, and new control house (for T & D).

Transmission: Construct a greenfield 115kV substation (61850), ring configuration with four bays.

An estimate for Alternative 2 is currently in development.

Cost Estimate: \$TBD million Total

Distribution: \$TBD million Substation \$TBD million Line

Transmission: \$TBD million Substation \$TBD million Line

Positives/Benefits:

- Meets standard design for the distribution equipment utilizing double-bus switchgear as identified by the Distribution System Planning Guide.

Additional Challenges/Risks:

- Same risks as identified for Alternative 1.

Project Scope (Preferred Solution – Alternative 2)

This alternative was selected as the preferred solution for the following reasons:

- This solution addresses all Distribution System Planning Guide violations. This includes adding transformer capacity to 1) substation STE capacity meets peak load demands and 2) increase the LCC capacity of the substation such that for the loss of a bus section all load can be restored via the remaining transformer and available circuit ties.
- The new distribution configuration will allow a normally open bus-tie breakers with an automatic bus restoral scheme.
- The distribution cost was competitive with other solutions while the switchgear provides a reliable design, less susceptible to animal contact.
- Substation can be constructed, tested, and commissioned prior to cutovers from old station. This minimizes testing and commissioning costs and significantly reduces outage planning and impacts to reliability during construction.
- Both T&D yards will be 61850 design which is the company greenfield design standard providing long term operational and reliability benefits.
- The transmission ring with proposed P&C upgrades provides a long-term solution resulting in a higher level of reliability and providing a configuration where maintenance activities can be performed without sacrificing system reliability.

Major Transmission-Level Yard Equipment - Removals

Remove all Transmission yard equipment.



Major Distribution-Level Yard Equipment - Removals

Remove all Distribution yard equipment.

Major Distribution Control House Equipment - Removals

1 Battery System 125 V Cells and chargers – 125 volt
1 Battery System 48 V CIP system – cell & charger – 48V

Major Transmission-Level Yard Equipment - Additions

4 Breakers 115 kV, 2000 A New vacuum breakers for breaker-and-a-half scheme.
12 Disconnect Switches 2,000 A Manually operated, bus-tie, with auxiliary contact switch
12 CCVTs 115 kV Six (6) located between the 115kV high-side of the transformer and the circuit switcher. Six (6) on the lines.
4 RIO Boxes Remote input/output boxes shall be placed adjacent to all 115 kV circuit breakers
700' Bus 115 kV Bus #2, 4" with 10 new stands
2 Bay Structures For transmission lines
120 Disc Insulators 115 kV 10 inch 115kV disc insulators
400' 1590 ACSR 45/7 strd, parallel 115kV Bus #1 and #2
300'x300' New Yard N/A With fencing, ground grid, and surfacing

Major Distribution-Level Yard Equipment - Additions

2 Power Transformers 62.5 MVA 115-34kV – TB22 (now TX22) and TB55 (now TX55) positions with associated foundations and oil containment
2 Circuit Switchers 1,200 A 115 kV, candlestick with associated foundations
2 Capacitor Banks 7.2 MVAR 34.5 kV, 7.2 MVAR banks
2 Cap Switchers 1,200 A 34.5 kV, off cap banks
2 Disconnect Switches 1,200 A 34.5 kV, off cap banks
2 Disconnect Switches 1,200 A 34.5 kV Circuit Breaker disconnects 1 Switchgear Unit
1 Switchgear Unit relay and control room - 11 breaker cubicles (4 Line with 2 spares, 2 Transformer, 2 Capacitor, 1 Bus-tie), 2 auxiliary cubicles, and 2 mobile connection cubicles.

Misc. Distribution Costs

1 Mobile XFMR Cost for a mobile transformer. Assumed \$30,000.
1 Sound Studies Cost for initial and final sound studies. Assumed to be \$25,000.

Major Transmission Control House Equipment - Additions

2 Telecommunications and SCADA system cabinets
1 COMM Cabinet for new Madbury comm channel
1 COMM Cabinet for new Three Rivers comm channel
1 CIP security cabinet, new, with control house and yard security equipment 250' Cable Trench
8 General Relay cabinets

Cost Estimate Backup Details

An updated estimate for Alternative 1 and a new estimate for Alternative 2 are currently in development.

Attachments (maps, images, one-line diagrams, MS PowerPoint presentations, MS Excel cost estimate files, etc.)

Existing Cocheco St (Dover) One-line
Transmission One-line
Cocheco Aerial with Property Lines
Cocheco Substation Aerial



Solution Selection Form

Date Prepared: 3/16/2021	Project Title: Monadnock Substation Rebuild
Company/ies: Eversource NH	Project ID Number: T1402A (T SS & Line), A18W06 (D SS), A19W49 (D Line)
Organization: System Planning	Class(es) of Plant: T&D Substation and Line
Project Initiator: Matt Cosgro	Project Category: Reliability/Asset Condition
Project Manager: Matt Cosgro	Project Type: Specific
Project Sponsor: Lavelle Freeman	Project Purpose: Address substation capacity and substation design deficiencies.
Estimated in service date: 12/31/2023	If Transmission Project: PTF? Yes

Project Need Statement:

The size of the existing transformers limit customer restoration capabilities for loss of one of the transformers or for loss of a bus section. The existing distribution arrangement combined with a limited capacity circuit tie severely restricts restoration capabilities for the contingency of a bus tie breaker failure. The 2020 forecast projects 2021 load levels on the station to be at 37.8 MVA, which with a load carrying capacity (LCC) of 34.8 MVA means that about 450 customers would experience a permanent outage following loss of transformer TB80. This load level also exceeds the station's short-term emergency (STE) rating of 30.0 MVA. Since there are no low-side transformer breakers, the outcome of a bus fault contingency is the exactly the same as loss of a transformer. For a bus tie breaker failure, both buses are affected causing loss of supply from Monadnock. During this contingency, 9,300 of the 12,900 customers would experience a permanent outage. Replacing the existing transformers with larger units will increase contingent capacity and equipment upgrades will increase station reliability so that all customers can be restored for an N-1 transformer, bus, or bus tie breaker contingency as required by the Distribution System Planning Guide design criteria.

A condition assessment has been conducted on TB40. The oil test data suggests signs of thermal fault or electrical discharge over past 1.5 years (5 oil samples in last 1.5 years). Spikes in H₂, C₂H₆ and C₂H₂ found on 5/23/18 indicate high energy electrical discharge. Another notable observation is a trending increase of C₂H₆ since 5/23/18. As of March 2021, transformer TB40 has a Long Term Health Index of 0.64 calculated by the PTX tool, indicating replacement is required.

Additional substation deficiencies include: No transformer low side breakers, no transformer high side circuit switchers, no automatic bus restoral scheme, and no space in distribution control house for additional relays. For an N-1 transformer contingency, all three 115 kV line circuit breakers and all three 34.5 kV line circuit breakers will automatically operate deenergizing the substation, interrupting transmission flows, and isolating 12,900 customers.

Substation personnel state that switching to remove a transformer from service requires switching in excess of 100 steps. The existing distribution strain bus is so low that movement of equipment requires a qualified spotter to simply traverse the yard. There is physically no way to position a line truck for maintenance on the J80 switch, TB80 transformer and other miscellaneous equipment.

The substation has only one circuit tie which is very limited due to the length (24 miles) and conductor size (4/0 ACSR). The 115kV bus is a simple straight bus. This design combined with the limited circuit tie



capability makes the substation especially susceptible to a 115kV bus fault or 115kV stuck line breaker which would cause the loss of both transformers and loss of nearly all customer load. Enhancement to the 115kV configuration is needed to address this risk.

Project Objectives:

Address violations of the Distribution System Planning Guide criteria. This includes 1) adding LCC capacity and equipment upgrades to increase reliability to customers supplied by Monadnock and 2) add high side circuit switchers and low side breakers to allow an automatic bus restoral scheme.

Guidance from Transmission Planning recommends a transmission ring design for a three-transmission line, two bulk transformer substation.

Address the transformer TB40 condition assessment by replacing the transformer.

Address substation deficiencies to prevent a distribution or transmission bus fault from isolating 12,900 customers at peak and allow maintenance activities to be performed without sacrificing system reliability. Add new 34.5 kV circuit breakers on the low side of each transformer and replacing the existing motor operated switches on the high side of each transformer with 115 kV circuit switchers. This will allow for the clearing of a faulted transformer without de-energizing the 115kV bus which results in loss of the second transformer and interrupting the 115kV transmission path. An automatic bus restoral scheme on the low side will restore all customers for an N-1 transformer contingency.

Alternatives Considered with Cost Estimates:

Non-wires alternatives (NWAs) are not a viable solution to this project, as no NWA is capable of addressing the asset condition issues and station design not to current standards, including the solid straight bus T configuration, the deteriorating condition of transformer TB40, the lack of high and low side transformer protection, two oil circuit breakers, condition of the distribution control house, electromechanical relays, and the oil circuit breakers.

All alternatives utilize the company standard 62.5 MVA top nameplate rated transformers. (LTE = 79 MVA, STE = 93 MVA typical)

Additional or changes in proposed design components are underlined in the alternative descriptions.

Alternative 1: (This option is no longer recommended)

Distribution: Rebuild the substation in a shared greenfield T&D yard (61850) with two 62.5 MVA transformers with transformer high side circuit switchers, transformer low side circuit breakers, 34.5 kV switchgear with normally open bus-tie breaker (which includes one spare line breaker cubicle and two mobile connection cubicles), an automatic bus restoral scheme, and a 5.4 MVAR capacitor bank (to supplement the existing 4.8 MVAR). Construct a new control house to be used by both transmission and distribution.

Transmission: Construct a greenfield T & D yard (61850) on property purchased adjacent to the existing site. The transmission yard would be a breaker and one-half design consisting five terminal bays (8 breakers) with a future breaker position for sixth terminal.

An updated estimate for Alternative 1 is currently in development.

Cost Estimate: \$TBD million Total



Distribution: \$TBD million Substation \$TBD million Line
Transmission: \$TBD million Substation \$TBD million Line

Positives/Benefits:

- Addresses bulk transformer and distribution bus failure contingencies.
- Prevents a 115kV bus fault or stuck 115kV line breaker from resulting in an outage to both transformers or interrupting the transmission path.
- Locates the control house on the same side of the street as the substation.
- Both T&D yards will be 61850 design which is the company greenfield design standard providing long term operational and reliability benefits.
- Creates space in the existing yard for a better distribution equipment layout addressing construction, clearance, and maintenance issues.
- Transmission breaker and one-half construction allows maintenance activities to take place without taking key elements out of service and negatively impacting system reliability.
- Switchgear is more resistant to animal contact while cost competitive with open air design.

Challenges/Risks:

- Greenfield transmission yard will require additional siting. Location is closer to a residential property.

Alternative 2: (This option is the new preferred alternative)

Distribution: Rebuild the substation in a shared greenfield T&D yard (61850) with two 62.5 MVA transformers with transformer high side circuit switchers, transformer low side circuit breakers, 34.5 kV double-bus switchgear with normally open bus-tie breaker (which includes one spare line breaker cubicle and two mobile connection cubicles), an automatic bus restoral scheme, and a 5.4 MVAR capacitor bank (to supplement the existing 4.8 MVAR). Construct a new control house to be used by both transmission and distribution.

Transmission: Construct a greenfield T & D yard (61850) on property purchased adjacent to the existing site. The transmission yard would be a ring design consisting three terminal bays (5 breakers) with a future breaker position for fourth terminal.

An estimate for Alternative 2 is currently in development.

Cost Estimate: \$TBD million Total

Distribution: \$TBD million Substation \$TBD million Line

Transmission: \$TBD million Substation \$TBD million Line

Additional Positives/Benefits:

- Addresses reliability for loss of the bus tie breaker failure.
- Reduces the number of breakers required for the transmission yard.

Additional Challenges/Risks:

- Same risks as identified in Alternative 1.



Project Scope (Preferred Solution – Alternative 2)

This alternative was selected as the preferred solution for the following reasons:

- Address violations of the Distribution System Planning Guide criteria. This includes 1) increasing LCC capacity and perform equipment upgrades to increase reliability to customers supplied by Monadnock and 2) add high side circuit switchers and low side breakers to allow an automatic bus restoral scheme.
- Prevents a 115kV bus fault or stuck 115kV breaker from interrupting the transmission path or causing an outage to both bulk transformers.
- Locates the control house on the same side of the street as the substation.
- Both T&D yards will be 61850 design which is the company greenfield design standard providing long term operational and reliability benefits.
- The distribution cost was competitive with other solutions while the switchgear provides a reliable design less susceptible to animal contact.
- The transmission breaker and a half configuration provides a long-term solution resulting in a higher level of reliability and providing a configuration where maintenance activities can be performed without sacrificing system reliability.
- The construction will be performed on a greenfield site which will facilitate construction and outage planning activities.

Major Transmission-Level Yard Equipment - Removals

Qty. Name Rating Description

7 Line Takeoff Structures N/A Line Takeoff removals
 3 Circuit Breakers 1,200 A Breaker removals
 18 Potential Transformers 115 kV Removals
 15 Surge Arresters 115 kV Removals
 7 Disconnect Switches 1,200 A 115 kV, motor operated
 3 SSVTs 50 kVA 120/208V
 1 Fused Disconnect Switch 200 A Fused
 1 Wave Trap 1,200 A Removals

Major Distribution-Level Yard Equipment - Removals

Qty. Name Rating Description

4 Circuit Breaker 1,200 A All low-side breakers
 3 Circuit Breaker Bays N/A
 All low-side breaker removals for switchgear installation, with associated structure-mounted equipment, including ten (10) 3φ disconnect switches, three (3) 1φ cap bank fused disconnect switches, nine (9) surge arresters, three (3) potential transformers, six (6) 1φ SSVT fused disconnect switches (relocated), six (6) 25 kVA SSVTs (relocated),
 1 Power Transformer 12/15/20 MVA 115 / 34.5 kV and foundation
 1 Power Transformer 15/20/28 MVA 115 / 34.5 kV and foundation
 2 Disconnect Switches 115 kV 2,000 A 115 kV Power transformer switches J40 and J80 removal, motor operated
 5 Potential Transformers 34.5 kV Two (2) to power transformer (PT) and three (3) line PTs
 Remaining removed equipment same as Option 1.

Major Transmission Control House Equipment - Removals

Qty. Description

1 Transmission Control House, removal (40'x40') w/ 20 panels
 1,000' Transmission trench removal

Major Distribution Control House Equipment - Removals

Qty. Description

1 Distribution Control House, removal (20'x20') w/ 10 panels



Major Transmission-Level Yard Equipment - Additions

Qty. Name Rating Description

- 1 New Yard N/A New Yard, 300'x300' with new fence, grounding, grading, and finish
- 4 Bay Structures 115 kV New bay structures
- 8 Circuit Breakers 115 kV 2,000 A, new foundations
- 16 Disconnect Switches 115 kV 2,000 A Structure mounted for new breaker-and-a-half scheme
- 21 Surge Arresters 115 kV Structure mounted
- 15 CCVTs 115 kV Nine (9) on line terminals and six (6) on the buses (w/ new structure)
- 1 Wave Trap 2,000 A 115 kV, Structure mounted
- 11 RIO Boxes

Remote input/output boxes shall be placed adjacent to the following:

- Three (3) for each motor-operated disconnect switch
- Eight (8) for each 115 kV circuit breaker

Major Distribution-Level Yard Equipment - Additions

Qty. Name Rating Description

- 2 Circuit Switchers 2,000 A 115 kV, with new steel and foundations
- 2 Transformer Switcher
- Disconnect Switch 115 kV For the transformers, motor operated
- 2 Power Transformers 62.5 MVA 115 / 34.5 kV, with new foundations
- 6 CCVTs 115 kV Power transformer CCVTs
- 9 RIO Boxes N/A

Remote input/output boxes shall be placed adjacent to the following:

Three (3) for the circuit switchers (115 kV and 34.5 kV) shared with their respective motor-operated switches

- Two (2) for both power transformers
- Four (4) for each 34.5 kV circuit breaker

- 1 Circuit Switcher 2,000 A 34.5 kV, with new steel and foundation, Cap Bank switcher
- 1 Cap Bank Switcher
- Disconnect Switch 34.5 kV C51J1 switch for the cap bank, motor operated
- 1 Cap Bank 5.4 MVAR 34.5 kV with reactors, new foundation
- 1 Switchgear Unit relay and control room (10 breaker cubicles (4 feeder with 1 spare, 2 transformer, 1 tie, 2 cap banks) and 2 auxiliary cubicles (PTs), and 2 mobile switch cubicles.
- 6 Voltage Transformers 25 kVA 34.5 kV - 120/208 V Station service XFMRs, relocated
- 6 Fused Disconnect
- Switches 100 A 1 ϕ fused disconnect switches for the station service transformers, relocated

Major Transmission Control House Equipment - Additions

Qty. Description

- 1,000' Transmission trench addition (for new yard cutover)
- 8 Breaker Control Cabinets
- 1 Bus Restoration Relay Cabinet
- 4 Disconnect Switch Cabinets
- 2 Line Protection Cabinets
- 2 Comm/Security Cabinets

Major Distribution Control House Equipment - Additions

Qty. Description

- 1 New Control House, for Distribution and Transmission, with panels, batteries, interior lighting and protection, HVAC and Hydrogen systems
- 1 HMI
- 1 RTU
- 2 Transformer Protection Cabinets
- 3 Circuit Switcher Control Cabinets
- 1 Cap Bank Control Cabinet
- 2 Disconnect Switch Cabinet



4 34.5 kV Breaker Control Cabinets
2 Line Protection Cabinets

Cost Estimate Backup Details

An updated estimate for Alternative 1 and a new estimate for Alternative 2 are currently in development.

Attachments (maps, images, one-line diagrams, MS PowerPoint presentations, MS Excel cost estimate files, etc.)

Existing Monadnock One-line
Monadnock Geographic One-line
Monadnock Substation Aerial
Aerial – Property Acquired
TB40 Condition Assessment



Appendix F – Project Authorization Forms

The information provided in this section is for approved project authorization forms for specific distribution line projects that are identified in the 2021 capital plan. Project authorization forms for annual projects (consisting of work orders less than \$100,000) such as Repairs and Obsolescence, NHDOT Line Relocations, Reliability, New Customer Services, and Tools and Equipment are not included. A list of the project titles is provided, followed by PDF's of the project authorization forms.

A17C30 - Pack Monadnock Rebuild	A21E09 3191X3 - 3191 Circuit Tie
A20C16 Bouchard St Replace Cable and MOST Switchgear	A21E21 63W1 Reconductor Drake Hill Rd
A20C24 Pad Step RTE 13	A21E22 3191X1A Piscassic Rd Conversion
A20C40 Replace Manchester Network Cables	A21E23 Fogg Rd Conversion
A20C46 317 Line Section Rebuild Warner	A21E24 Beauty Hill Road Conversion
A20E47 Codfish Corner Rd	A21LS Distribution Line Sensors
A20E48 Foundry Place Switchgear	A21N28 Route 16 Line Relocation NHDOT (needs Revisions)
A20N50 Line Relocation Route 106 Loudon	A21N46 IRU Fiber IFR
A20W33 - Pack Monadnock Summit Rebuild	A21S12 Apple Tree Cinema URD Rebuild
A21C05 Reconductor Academy Rd	A21S13 Pine Isle Drive URD Rebuild
A21C19 Meetinghouse Rd Substation Offload	A21S27 Damren Rd. Conversion
A21C20 322X14 Off-load	A21W36 Remove Lattice Steel Towers
A21C25 360X5 Reconductor New Boston Rd	A21W37 Extend Three Phase Route 202 Rindge
A21C42 Westland Ave Conversion	CO1PCB 2021 PCB Transformer Removals
A21E08 3191X1B-377X2 Circuit tie	



APS 1 - Project Authorization Policy

Appendix 2
Operations Project Authorization Form

Operations Project Authorization Form

Date Prepared: 4/15/2020	Project Title: Rebuild Pack Monadnock Distribution Line
Company/ies: Eversource NH	Project ID Number: A17C30
Organization: Electric Field Operations	Class(es) of Plant: Distribution Line
Project Initiator: Julie Walsh/ Mark Fraser	Project Category: Reliability -Obsolete Equipment Line
Project Manager: Tom Davis	Project Type: Specific
Project Sponsor: Mark Sandler	Project Purpose: Replace aged and unsafe facilities
Estimated in service date: 11/1/2020	If Transmission Project: N/A
Eng. /Constr. Resources Budgeted? Yes	Capital Investment Part of Original Operating Plan? Yes
Authorization Type: Full Funding	O&M Expenses Part of the Original Operating Plan? Yes
Total Request: \$3,900,000	

Financial Requirements:

Executive Summary

Approximately three years ago, SegTel, Inc. d/b/a FIRSTLIGHT FIBER, a third-party telecommunication company, requested pole attachments on the utility line running from Highway Route 101 up to the top of Pack Monadnock. This line is approximately 5,200 feet long. The line was originally installed in the 1930's by Greenville Electric Light Company and New England Telephone and Telegraph Company. The initial review of this project showed the need for significant facility upgrades. The project caught the attention of the New Hampshire Public Utilities Commission, the New Hampshire Division of Parks and Recreation, local and State elected officials and members of the public who use the park. In April of 2017, the NH PUC Director of Safety and Security visited the location and cited many safety violations on both the electric and communication facilities.

Because of the sensitive nature of this project and our desire to meet the safety, reliability, aesthetic, and community needs and expectations, a collaborative process was established involving the public, State, and Eversource. Over the last three years, numerous public sessions and site meetings were held. Multiple options were explored, reviewed, modified, and, eventually, a mutually agreed upon plan was selected. Eversource will construct a new 5,200 foot overhead line to the summit utilizing 30 poles. This line will be in agreed upon ROW. The existing pole line and primary cable in conduit laying on the ground will be removed. The electric facilities at the summit of the mountain will be addressed under a separate project.



APS 1 - Project Authorization Policy

Appendix 2
Operations Project Authorization Form

Project Costs Summary

Note: Dollar values are in thousands

	Prior Authorized	20__	20__	20__+	Totals
Capital Additions - Direct	\$ 25	\$ 2,240	\$ -	\$ -	\$ 2,265
Less Customer Contribution	-	-	-	-	-
Removals net of Salvage ____ %	-	-	-	-	-
Total - Direct Spending	\$ 25	\$ 2,240	\$ -	\$ -	\$ 2,265
Capital Additions - Indirect	-	1,620	-	-	1,620
Subtotal Request	\$ 25	\$ 3,860	\$ -	\$ -	\$ 3,885
AFUDC	-	15	-	-	15
Total Capital Request	\$ 25	\$ 3,875	\$ -	\$ -	\$ 3,900
O&M	-	-	-	-	-
Total Request	\$ 25	\$ 3,875	\$ -	\$ -	\$ 3,900

Financial Evaluation

Note: Dollar values are in thousands

Direct Capital Costs	Year 1	Year 2	Year 3+	Total
Straight Time Labor	435			435
Overtime Labor	0			0
Outside Services	1760			1760
Materials	70			70
Other, including contingency amounts (describe)				
Total	2,265			2,265

Indirect Capital Costs	Year 1	Year 2	Year 3+	Total
Indirects/Overheads (including benefits)	1,620			1,620
Capitalized interest or AFUDC, if any	15			15
Total	1,635			1,635

Total Capital Costs	3,900			3,900
----------------------------	--------------	--	--	--------------

Less Total Customer Contribution				
----------------------------------	--	--	--	--

Total Capital Project Costs	3,900			3,900
------------------------------------	--------------	--	--	--------------

Total O&M Project Costs				
------------------------------------	--	--	--	--

Note: Explain unique payment provisions, if applicable



APS 1 - Project Authorization Policy

Appendix 2
 Operations Project Authorization Form

Future Financial Impacts:

Provide below the estimated future costs that will result from the project:

Note: Dollar values are in thousands:

Future Costs	Year 20__	Year 20__	Year20__	Year 20__+	Total Future Project Costs
Capital	\$ -	\$ -	\$ -	\$ -	\$ -
O&M	-	-	-	-	-
Other	-	-	-	-	-
TOTAL	\$ -	\$ -	\$ -	\$ -	\$ -

Describe the estimated future Capital, O&M and/or Other costs noted above:

What functional area(s) will these future costs be funded in? _____

A representative from the respective functional area is required to be included as a project approver.

If this is other than a Reliability Project, please complete the section below:

Provide below the estimated financial benefits that will result from the project:

Note: Dollar values are in thousands:

Future Benefits	Year 20__	Year 20__	Year20__	Year 20__+	Total Future Project Benefits
Capital	\$ -	\$ -	\$ -	\$ -	\$ -
O&M	-	-	-	-	-
Other	-	-	-	-	-
TOTAL	\$ -	\$ -	\$ -	\$ -	\$ -

Describe the estimated future Capital, O&M and/or Other benefits noted above:

What functional area(s) will these benefits be reflected in? _____

A representative from the respective functional area is required to be included as a project approver.

Asset Retirement Obligation (ARO) and/ or Environmental Cleanup Costs (Environmental Liabilities):

An ARO is a current legal obligation to remove or retire property, plant or equipment at some point in the future. Please refer to APS8 or contact Plant Accounting for further detail.

Is there an ARO associated with this project? No

Are there other environmental cleanup costs associated with this project? No.



APS 1 - Project Authorization Policy

 Appendix 2
 Operations Project Authorization Form

Technical Justification

Project Need Statement

An off-road single-phase primary electric power line was constructed up the side of Pack Monadnock Mountain over 90 years ago to service buildings, observatories, and communication equipment located at the top. The feed begins as overhead pole line construction and transitions to above ground cable in conduit halfway up the mountain. The pole plant and conductors are in poor condition and not accessible for repair because of the extremely rugged terrain. The conduit system along the ground is also in poor condition. Some of the conduit is suspended high in the air due to the uneven terrain of the mountainside. This existing construction poses a safety risk to the public, accessibility issues for line crews, and has had numerous safety violations cited by the NH PUC Director of Safety and Security (see References section below).

Project Objectives

The objective of this project is to provide safe and reliable power to the services at the summit of the mountain. All safety issues associated with the existing line will be addressed and reasonable access will be obtained for maintenance and restoration. It is also important that we work closely with local and State stakeholders to minimize impacts to the State Park and its guests.

Project Scope

The scope of this project is to construct a new 5,200 foot of primary single-phase line with covered primary conductor. Thirty new poles will be installed. All of the existing line and equipment up to the summit will be removed. A new service will be run to the MIT building, located approximately halfway up the mountain. Work associated with the summit will be addressed under a separate Project Authorization.

Background / Justification

The existing electric facilities are in disrepair and pose a potential safety hazard to the public. On April 21, 2017, an inspection by New Hampshire Public Utilities Commission Director of Safety and Security Randy Knepper found multiple safety and code violations on both utility and the customer owned equipment. Eversource was directed to rebuild the line to today's codes and standards, thereby resolving the identified code violations.

Also, communications companies segTEL Inc., and Comcast is requesting attachment to facilities to connect their services to the mountain summit.

Business Process and / or Technical Improvements

The new line is be constructed overhead with covered conductor. The covered wire should improve resiliency of the line and improve protection from tree contact. The new poles will be stronger and able to withstand greater tree contact and weather conditions. Also, this line is being constructed with guidance from Hendrix Cable, a New Hampshire company that is the leader in spacer cable and tree wire installations. Better line clearing and access are being created through this upgrade.

Cost Estimate and Assumptions

This project has been fully written in STORMS. Costs have been derived from closely working with Engineering, Operations, Vegetation Management, Surveying, Transmission Construction and Maintenance, Scheduling and Planning, preferred contractors, preferred vendors, and our regulatory group.



APS 1 - Project Authorization Policy

Appendix 2 Operations Project Authorization Form

Alternatives Considered with Cost Estimates

Multiple alternatives have been considered including various overhead and underground options. All were reviewed internally and with external stakeholders. The final solution for this upgraded line was the result of three years of negotiations, public forums, site meetings, constructability reviews, and buy-in from our State partners.

Project Schedule

Milestone/Phase Name	Estimated Completion Date
Construction Start	
Construction completion	11/1/20

Regulatory Approvals

There were many State permits required by New Hampshire's Department of Natural and Cultural Resources, New Hampshire DOT, New Hampshire PUC, and other State requirements. These are all in progress and expected to be approved.

Risks and Risk Mitigation Plans

We have been working through these issues for the last three years. We need to continue our strong communication with our State partners and other stakeholders to ensure a positive result and response to this project.

References

Preliminary funding PAF dated 5/9/2017 is attached.

One-Line Diagrams, Attachments, and Images

Included in Preliminary Funding PAF, attached.



APS 1 - Project Authorization Policy

Appendix 2
Operations Project Authorization Form

Operations Technical Authorization Form

TAF # NH-170037-D

Date Prepared: 5/9/2017	Project Title: Rebuild Single-Phase Line Servicing Pack Monadnock Summit
Company/ies: Eversource NH	Project ID Number: A17C30
Organization: Electric Field Operations	Class(es) of Plant: Distribution Line
Project Initiator: Julie Walsh	Project Category: Reliability - Obsolete Equipment - Line
Project Owner/Manager: Marc Pilotte	Project Type: Specific
Project Sponsor: Jim Eilenberger	Project Purpose: PUC Requirement to replace unsafe line
Estimated in service date: 11/1/17	If Transmission Project: NA
Authorization Type: Detailed Engineering	Authorization Amount: \$22,500

Project Need Statement

This request is for \$22,500 to design this project in the Storms work management system. This figure is based on 10% of the estimated cost of \$225,000.

Single-phase service to several communications towers and other services atop Pack Monadnock was constructed many years ago using above-ground cable in conduit. In places, this conduit is suspended high in the air, due to the uneven terrain of the mountainside. This existing construction poses a safety risk to the public, accessibility issues for line crews, and has had numerous safety violations cited by the NH PUC Director of Safety and Security (see References section below).

Project description

Rebuild second half of line from the end of the existing overhead section to the top of the mountain with single-phase spacer cable along the access road. Remove old above-ground facilities in conduit and vault.

Project Objectives

Comply with PUC request by removing unsafe and obsolete primary line construction and replacing with new overhead construction. Project also facilitates a current Segtel request for third party attachment.

Project Scope

Rebuild approximately 3000 feet of primary line with single phase 1/0 spacer cable. Install 20 new Class 2 poles. Remove approximately 2400 feet of old above-ground cable in conduit, one vault containing a cutout, and several risers. Add one service transformer at the end of primary to split load and shorten secondary runs.

It is anticipated that initial tree clearing to be completed by NH State Parks Department, however, there is no firm commitment as of the date of this document.



APS 1 - Project Authorization Policy

Appendix 2

Operations Project Authorization Form

Background / Justification

Electric facilities are now obsolete as constructed. They are unsightly and a potential safety hazard to the public. An inspection by PUC Director of Safety and Security Randy Knepper on April 21, 2017 found multiple violations on both the utility and the customer equipment, for both electric power and telecommunications. Eversource was requested to propose an overhead solution to address the electric utility violations since the amount of ledge and outcroppings in the terrain prohibit an underground solution. Segtel is requesting attachment to facilities to connect their services to the mountain summit.

Business Process and / or Technical Improvements:

Regulatory Requirement, System renewal.

Cost Estimate and Assumptions

\$225,000 –This cost estimate assumes 18 overhead spans at \$10,000 per pole span (\$7000 for pole, wire, and other hardware, plus \$3000 extra to cover tree removals and ledge pole sets). An additional \$45,000 is included for removals.

Alternatives Considered with Cost Estimates

Replace above-ground conduit with direct-buried cable in conduit. Due to the rugged mountain terrain, this was not considered a viable option. Randy Knepper, PUC Director of Safety & Security, proposes an overhead solution as the current terrain prohibits an underground solution.

Project Schedule

Describe the project schedule and milestones. Include estimated start and end dates.

Milestone/Phase Name	Estimated Completion Date
Tree clearing	8/1/17
Poles set	9/1/17
Line work complete	11/1/17

Regulatory Approvals

None

Risks and Risk Mitigation Plans

The State (DRED) is indicating a willingness to pay for the initial tree removals. However, there is no obligation for them to do so yet, and therefore removals have been included in the cost estimate.



APS 1 - Project Authorization Policy

Appendix 2
Operations Project Authorization Form

References

Email from PUC Director of Safety and Security from 4/24/17:

From: "Knepper, Randy" <Randy.Knepper@puc.nh.gov>
 To: "Spoerl, Robert" <Robert.Spoerl@dred.nh.gov>, Ronald L. Pepin/NUS@NU,
 Cc: James C. Eilenberger/NUS@NU, Marc W. Pilotte/NUS@NU, Karen T. Mackey/NUS@NU,
 PSNHPUCLiaison@NU, "Linnenbringer, Frank" <Frank.Linnenbringer@dot.nh.gov>, "Lyons,
 Johanna" <Johanna.Lyons@dred.nh.gov>
 Date: 04/24/2017 10:28 AM
 Subject: RE: Pack Monadnock utility relocation

Yes, my inspection on April 21, 2017 found numerous safety violations both on the customer side and utility. This includes electric power and telecommunications. I am less concerned on how and why but more concerned on reinstalling the utilities and private service connections in a manner that is safe, legal, documented, properly placed, well coordinated and can last into the future. The present situation was created over time in a haphazard manner but can be rectified. This will involve coordination between the end users, multiple state agencies, private land owners, power and telecommunications providers and requires a collaborative approach. The PUC can act as a co-facilitator. I envision multiple meetings to get things moving. At this point I have informed our general counsel and she will be reaching out to AG's office to help coordinate. Here are my initial thoughts:

- 1) Legal Research – which statutes and rules apply including licensing
- 2) Land and Parcel Research – build a historical record of each segment
- 3) Survey/ GPS/ GEOcoding –any existing portion that will be reused, new proposals, and new installation
- 4) Define current and future needs of end users
- 5) Design and Layout – Eversource needs to propose an **overhead solution** – the amount of ledge and outcroppings prohibit an underground solution
- 6) Coordination with attachees
- 7) Cost considerations and scheduling considerations
- 8) View, Park needs, end user needs and ROW considerations

My suggestion is for Eversource to propose a preliminary solution with any potential options to get us rolling.

Randy Knepper
 Director of Safety and Security
 New Hampshire Public Utilities Commission
 21 South Fruit St
 Concord NH 03301
 603-271-6026



APS 1 - Project Authorization Policy

Appendix 2
Operations Project Authorization Form

One-Line Diagrams, Attachments, and Images

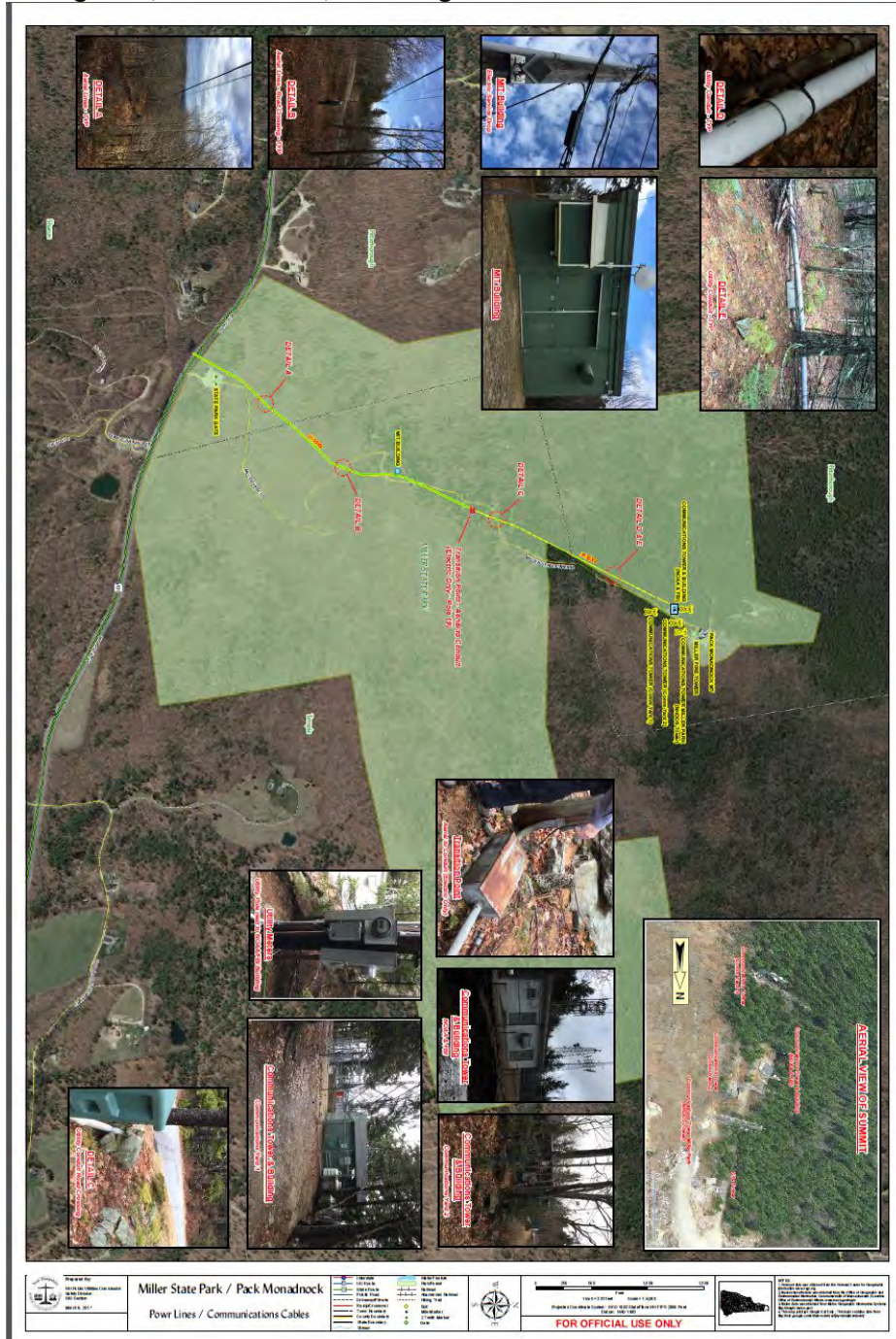



APS 1 - Project Authorization Policy

Appendix 2
Operations Project Authorization Form





APS 1 - Project Authorization Policy

Appendix 2
Operations Project Authorization Form





APS 1 - Project Authorization Policy

Appendix 2
Operations Project Authorization Form



EVERSOURCE

Project Authorization Form

Operations Project Authorization Form

Date Prepared: 4/21/20	Project Title: Bouchard St Cable/Swgr Replacement
Company: Eversource NH	Project ID Number: A20C16
Organization: Electric Field Operations	Class of Plant: Distribution Line
Project Initiator: Robert Krewson	Project Category: Reliability – Distribution Lines
Project Manager: Marc Pilotte	Project Type: Specific
Project Sponsor: Russel Johnson	Project Purpose: Replace Cable and Switchgear
Estimated in service date: 10/1/20	If Transmission Project: PTF? N/A
Eng. /Constr. Resources Budgeted? Yes	Capital Investment Part of Original Operating Plan? Yes
Authorization Type: Full Funding	O&M Expenses Part of the Original Operating Plan? Yes
Total Request: \$544,000	

Financial Requirements:

Project Authorization

ERM: _____

FP&A: _____

Executive Summary

This project is to install approximately 1,100 feet of three phase spacer cable to eliminate 2,500 feet of direct buried cable on Bouchard Street in Manchester, NH. This 1970s vintage cable, which has failed several times in the recent past, is at the end of its expected life-span. Customer pad-mounted transformers will be re-fed by risers and new cable in conduit.

An RTE M.O.S.T. switchgear (oil filled) and a sector cabinet will also be retired. The switchgear removal is consistent with ESNH efforts to retire oil-filled switchgear. ESNH has made elimination of such equipment a priority.

Additionally, two live front transformers will be replaced. A dead front unit will be relocated to a more optimum spot next to the building it serves.

EVERSOURCE

Project Authorization Form

Project Costs Summary

Note: Dollar values are in thousands

	Prior Authorized	2020	20__	20__+	Totals
Capital Additions - Direct	\$ -	\$ 251	\$ -	\$ -	\$ 251
Less Customer Contribution	-	-	-	-	-
Removals net of Salvage %	-	41	-	-	41
Total - Direct Spending	\$ -	\$ 292	\$ -	\$ -	\$ 292
Capital Additions - Indirect	-	250	-	-	250
Subtotal Request	\$ -	\$ 542	\$ -	\$ -	\$ 542
AFUDC	-	2	-	-	2
Total Capital Request	\$ -	\$ 544	\$ -	\$ -	\$ 544
O&M	-	-	-	-	-
Total Request	\$ -	\$ 544	\$ -	\$ -	\$ 544

Financial Evaluation

Note: Dollar values are in thousands

Direct Capital Costs	Year 1	Year 2	Year 3+	Total
Straight Time Labor	32			32
Overtime Labor	14			14
Outside Services	200			200
Materials	34			34
Other, including contingency amounts (describe)	12			12
Total Direct Costs	292			292
Indirect Capital Costs	Year 1	Year 2	Year 3+	Total
Indirects/Overheads (including benefits)	250			250
Capitalized interest or AFUDC, if any	2			2
Total Indirect Costs	252			252
Total Capital Costs	544			544
Less Total Customer Contribution	0			0
Total Capital Project Costs	544			544
Total O&M Project Costs	0			0

Note: The "Other, including contingency amounts" cost is for Eversource vehicle and equipment per the Storms estimate.

Estimate includes costs for overtime labor and civil work to cutover four customer locations on four separate Saturdays (conduit extension, installation of primary/secondary conductors).



Future Financial Impacts:

Provide below the estimated future costs that will result from the project:

Note: Dollar values are in thousands:

Future Costs	Year 20__	Year 20__	Year20__	Year 20__ +	Total Future Project Costs
Capital	\$ -	\$ -	\$ -	\$ -	\$ -
O&M	-	-	-	-	-
Other	-	-	-	-	-
TOTAL	\$ -	\$ -	\$ -	\$ -	\$ -

Describe the estimated future Capital, O&M and/or Other costs noted above:

What functional area(s) will these future costs be funded in? _____

A representative from the respective functional area is required to be included as a project approver.

If this is other than a Reliability Project, please complete the section below:

Provide below the estimated financial benefits that will result from the project:

Note: Dollar values are in thousands:

Future Benefits	Year 20__	Year 20__	Year20__	Year 20__ +	Total Future Project Benefits
Capital	\$ -	\$ -	\$ -	\$ -	\$ -
O&M	-	-	-	-	-
Other	-	-	-	-	-
TOTAL	\$ -	\$ -	\$ -	\$ -	\$ -

Describe the estimated future Capital, O&M and/or Other benefits noted above:

What functional area(s) will these benefits be reflected in? _____

A representative from the respective functional area is required to be included as a project approver.

Asset Retirement Obligation (ARO) and/ or Environmental Cleanup Costs (Environmental Liabilities):

Is there an ARO associated with this project? If yes, please provide details: No

Are there other environmental cleanup costs associated with this project? No

EVERSOURCE

Project Authorization Form

Technical Justification

Project Need Statement

This project installs a combination of overhead spacer and new riser cables to supply large industrial and commercial customers on Bouchard St. It replaces 1973 vintage, 34kv direct buried cables which have become increasingly vulnerable to failure. It will also remove a M.O.S.T. switchgear as part of Eversource's efforts to retire such oil filled equipment.

Project Objectives

Replace the distribution cable feeding five customers in the Bouchard St industrial park area. In addition, an oil filled M.O.S.T. switchgear will be eliminated.

Project Scope

The current three phase 1/0 underground cable feeding the Bouchard St tap will be replaced by approximately 1,100 feet of three phase 1/0 AAC spacer cable. Six poles will be installed and nine poles will be replaced. Elimination of the M.O.S.T switchgear and a sector cabinet will be accomplished by the construction of three risers. Two live front transformers will be replaced, with another unit relocated to a more optimum spot next to the building it serves. Approximately 1,800 feet of 5" conduit will be needed for the civil portion of the job.

Background / Justification

This project replaces 1,100 feet of direct buried 34 kV cable which was installed in 1973 and has experienced several failers in the recent past. I also eliminates a piece M.O.S.T. switchgear, which aligns with Company efforts to retire all oil insulated switchgear. Design work for the project has been completed in STORMS by Leidos.

Business Process and / or Technical Improvements:

The DB cable retirement would improve area reliability since there have been several cable failures in past years. This project would also retire a piece of oil-filled switchgear. ESNH has made retirement of such equipment a priority.

Alternatives Considered with Cost Estimates

- 1) Leave the existing cable system as is. However, a good portion of this cable tested in 2013 yielded marginal results (neutral deterioration of < 50% capacity), and there have been several cable failures over the past years. Therefore, it is advisable to replace the existing cable.

Replacement of all direct buried cable on Bouchard St with cable in conduit was considered too expensive (\$654,000 total job cost). So while customers will continue to have underground cable feeds to their pad-mounted transformers, the main line cable on Bouchard is proposed to be replaced with overhead spacer cable.

- 2) A cost reducing measure would be to remove Gentex Corporation at 645 Harvey Rd from the project. This facility is fed from a separate riser pole and cable. It was included in the original project because the cable is also of 1970's vintage and its transformer is live-front. The estimated cost savings for removing this work from the project is \$95,000.

Project Schedule

Milestone/Phase Name	Estimated Completion Date
Design work by Leidos	Completed
Installation of overhead spacer cable on Bouchard St	7/30/2020
Install three risers to cable feeding five pad-mounted transformers	9/30/2020
Project in Service	10/1/2020

REDACTED
EVERSOURCE
Project Authorization Form

Regulatory Approvals

The FAA originally granted approval for the Bouchard St poles. Since the licensing period has expired, reapplication will need to be made. This approval is necessary due to the proximity of the new OH line to Manchester airport.

Risks and Risk Mitigation Plans

There are several easements which must be obtained for the pole line work. There have been some negotiations with customers at 140/160 Bouchard St in which minor site improvements will be made in exchange for permission to install equipment/anchors.

Outages will be required for all customers since riser cables, and in some cases transformers, are being replaced. The pole sets occur in the Eversource custodial area (East Manchester).

The cost for both of these items is included in the requested amount.

Permission has been obtained for tree trimming work required for the spacer cable installation.

References

None.

Attachments (One-Line Diagrams, Images, etc.)

Proposed Construction

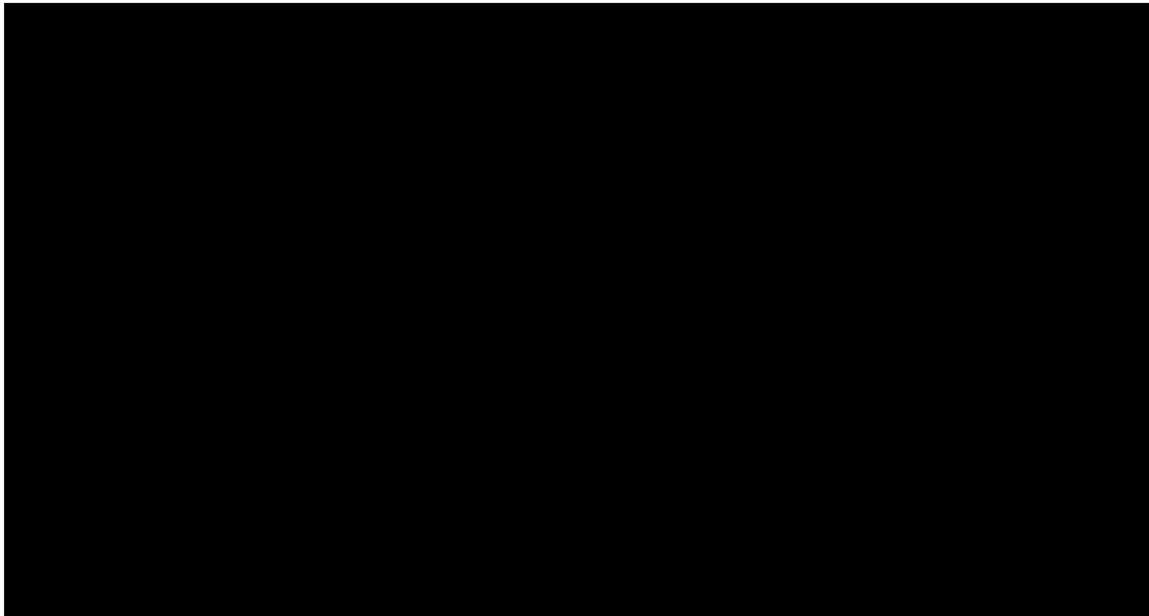

REDACTED
EVERSOURCE
Project Authorization Form

PSNH dba Eversource Energy
Docket No. DE 20-161
Least Cost Integrated Resource Plan
March 31, 2021 Supplement
Appendix F-2
Page 6 of 6

Existing Conditions

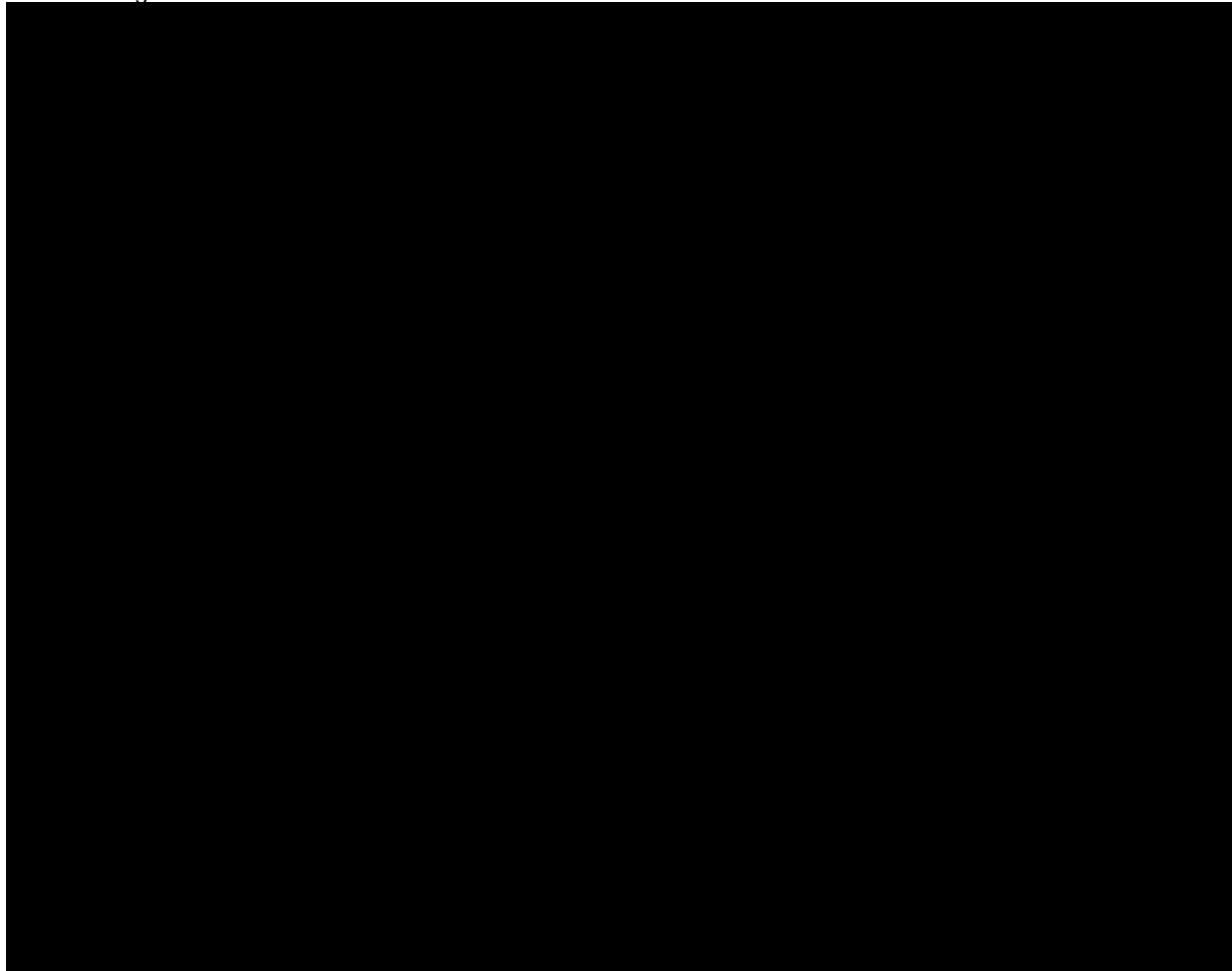



EVERSOURCE
Project Authorization Form

Operations Project Authorization Form

Date Prepared: 06/02/2020	Project Title: Install Pad Mount Step Route 13, Dunbarton
Company/ies: NH	Project ID Number: A20C24
Organization: Field Engineering	Class(es) of Plant: Distribution Line
Project Initiator: Michael Warren	Project Category: Peak Load/Capacity – Distribution Lines
Project Manager: Marc Pilotte	Project Type: Specific
Project Sponsor: Marc Pilotte	Project Purpose: Overloaded Parallel 500 kVA Steps
Estimated in service date: 12/15/2020	If Transmission Project: PTF? N/A
Eng. /Constr. Resources Budgeted? Y	Capital Investment Part of Original Operating Plan? Y
Authorization Type: Full Funding	O&M Expenses Part of the Original Operating Plan? Y
Total Request: \$407,000	

Financial Requirements:

Project Authorization

ERM: _____

FP&A: _____

Executive Summary

This project is to install a 5 MVA pad-mounted step transformer to off-load the parallel step transformers feeding the 3271X1 circuit at Route 13 in Goffstown. Two of the three parallel 500 kVA step banks exceeded nameplate loading reaching 105% and 114% for summer 2019. This project was approved by CPAC in 2019 with an initial budget of \$75K for engineering, site evaluation and easement work. This request is for full financial approval.

EVERSOURCE

Project Authorization Form

Project Costs Summary

Note: Dollar values are in thousands

	Prior Authorized	2019	2020	20__+	Totals
Capital Additions - Direct	\$ -	\$ -	\$ 273	\$ -	\$ 273
Less Customer Contribution	-	-	-	-	-
Removals net of Salvage ____%	-	-	-	-	-
Total - Direct Spending	\$ -	\$ -	\$ 273	\$ -	\$ 273
Capital Additions - Indirect	-	-	131	-	131
Subtotal Request	\$ -	\$ -	\$ 404	\$ -	\$ 404
AFUDC	-	-	3	-	3
Total Capital Request	\$ -	\$ -	\$ 407	\$ -	\$ 407
O&M	-	-	-	-	-
Total Request	\$ -	\$ -	\$ 407	\$ -	\$ 407

Financial Evaluation

Note: Dollar values are in thousands

Direct Capital Costs	Year 1	Year 2	Year 3+	Total
Straight Time Labor	26			
Overtime Labor				
Outside Services	104			
Materials	105			
Other, including contingency amounts (describe)	38			
Total Direct Costs	273			
Indirect Capital Costs	Year 1	Year 2	Year 3+	Total
Indirects/Overheads (including benefits)	131			
Capitalized interest or AFUDC, if any	3			
Total Indirect Costs	134			
Total Capital Costs	407			
Less Total Customer Contribution				
Total Capital Project Costs	407			
Total O&M Project Costs				

Note: "Other" category consists of easement costs as well as contingency cost for various additional costs for installing pad-mount step transformer (oil retention and or site work). The above evaluation does not include \$66K for the actual purchase of the pad-mount step transformer because it is a precapitalized item.

EVERSOURCE
 Project Authorization Form

Future Financial Impacts:

Provide below the estimated future costs that will result from the project:

Note: Dollar values are in thousands:

Future Costs	Year 20__	Year 20__	Year20__	Year 20__ +	Total Future Project Costs
Capital	\$ -	\$ -	\$ -	\$ -	\$ -
O&M	-	-	-	-	-
Other	-	-	-	-	-
TOTAL	\$ -	\$ -	\$ -	\$ -	\$ -

Describe the estimated future Capital, O&M and/or Other costs noted above:

What functional area(s) will these future costs be funded in? _____

A representative from the respective functional area is required to be included as a project approver.

If this is other than a Reliability Project, please complete the section below:

Provide below the estimated financial benefits that will result from the project:

Note: Dollar values are in thousands:

Future Benefits	Year 20__	Year 20__	Year20__	Year 20__ +	Total Future Project Benefits
Capital	\$ -	\$ -	\$ -	\$ -	\$ -
O&M	-	-	-	-	-
Other	-	-	-	-	-
TOTAL	\$ -	\$ -	\$ -	\$ -	\$ -

Describe the estimated future Capital, O&M and/or Other benefits noted above:

What functional area(s) will these benefits be reflected in? _____

A representative from the respective functional area is required to be included as a project approver.

Asset Retirement Obligation (ARO) and/ or Environmental Cleanup Costs (Environmental Liabilities):

Is there an ARO associated with this project? No

Are there other environmental cleanup costs associated with this project? No

EVERSOURCE

Project Authorization Form

Technical Justification

Project Need Statement

This project installs a 5 MVA pad-mounted step transformer to replace the parallel step transformers on the 3271X1 circuit at Route 13 (Pattee Hill Road) in Goffstown. Two of the three parallel banks exceeded nameplate value during the summer of 2019. Phase A reached 105% and Phase C reached 114% of nameplate value.

Project Objectives

Off-load overloaded step transformers on Pattee Hill Road by replacing the steps with a 5 MVA pad-mounted step. Solution addresses over loaded step transformers, bringing all phases to less than 70% of nameplate value rating of the padmounted step. This solution addresses loading on the circuit for approximately 7 years when the #2 main line conductor is projected to reach 100% normal rating, using a 2% growth rate.

Project Scope

Install one 19.9/34.5 kV to 7.2/12.47 kV, 5 MVA three phase pad-mounted step transformer and remove the six existing 500 KVA steps. Utilize existing load side 12.47 kV DA SCADA device. An easement or land purchase of \$30K to place the new transformer has been included in the cost estimate.

Background / Justification

Eliminate overloaded step transformers on the 3271X1 circuit and attempt to load balance circuit off Route 13 Pattee Hill Road in Goffstown and Dunbarton. Two sets of parallel 500 KVA step transformers exceeded nameplate loading reaching 105% and 114% during summer of 2019. A new DA device installed prior to summer load showed loading as 105%, 72%, 114%. Load balancing to bring the other two phases under 100% was investigated, but loading is sparse along the main line except for a few large side taps. Moving these side taps will simply swap the over load from one phase to another.

The north end of the 3271X1 is single phase (phase B) which is the lowest loaded phase, so pulling off load to the north via an abutting circuit will not aid in off loading the step transformers. To the east is another utility.

Business Process and / or Technical Improvements:

- Addresses overloaded parallel 500 KVA step transformers.
- Addresses future load growth of 2% for 15.5 years based on the step transformers, and 6.5 years based on the existing #2 ACSR main line conductor normal summer ratings (190 amps).
- Leaves capacity for a potential 12 kV tie to the 37W1 circuit to the north.

Alternatives Considered with Cost Estimates

Alternative 1: Reconductor and convert up Route 13 for 3.88 miles just beyond Gorham Pond Road (pole 13/217). Initial assessment by Designer shows having to replace or work on almost half the poles in this section. In addition, current standard is covered wire so the existing #2 ACSR would be replaced with 477 spacer cable. Addresses future loading on 1000 KVA steps for 8 years based on 2% load growth. Step loading (60%,35%,84%). No simple load balancing available. Estimated at \$2,412,000

Alternative 2: Reconductor and convert up Route 13 for 2 miles just beyond Paige Hill Road (pole 13/116). Initial assessment by Designer shows having to replace or work on almost half the poles in this section. In addition, current standard is covered wire so the existing #2 ACSR would be replaced with 477 spacer cable. Addresses future loading on 1000 KVA steps for 3 years based on 2% load growth. Step loading (94%, 94%,68%). All simple load balancing taken into account. Estimated at \$1,382,000

Project Schedule

Milestone/Phase Name	Estimated Completion Date
Easement Process	07/01/2020
Engineering/Writing Complete	04/01/2020
Construction Begins	08/15/2020
Estimated In-Service Date	12/15/2020

Regulatory Approvals

None.

Risks and Risk Mitigation Plans

Padmount step lead time – Anything beyond 7 months normal lead time may push completion time into winter of 2021. This is acceptable as 3271X1 circuit is a summer peaking circuit.

Easement rights – Failure to secure easement rights at the circuit tap will mean looking further down the circuit for potential locations or implementing an alternative solution. The customer has verbally agreed to the easement and the company is preparing the necessary paperwork.

References

Project Overview, 3271X1 pad-mounted step plan

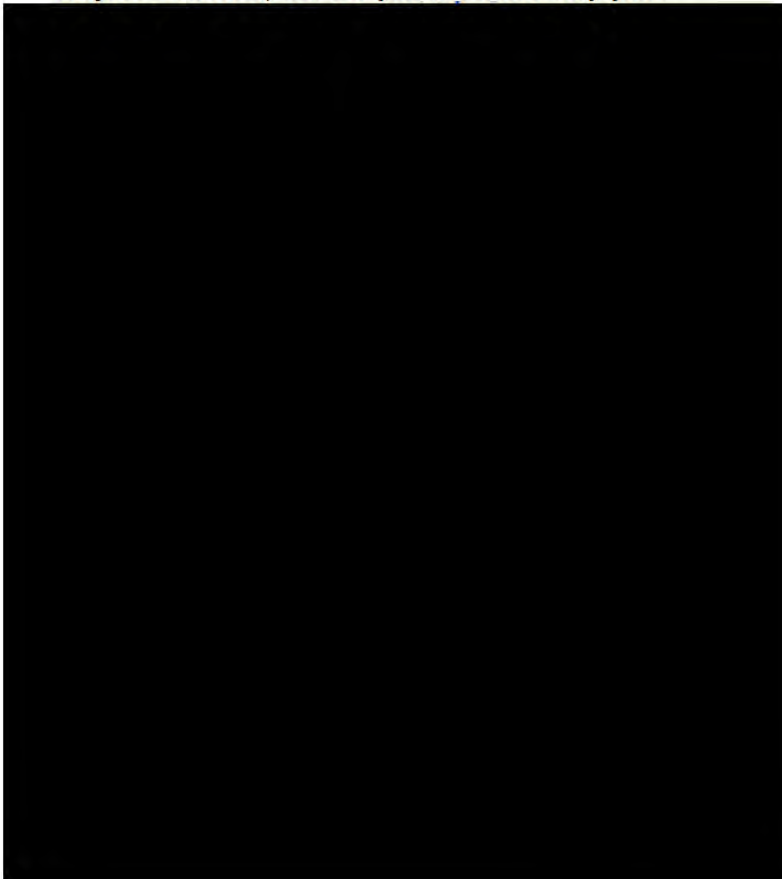

EVERSOURCE
Project Authorization Form**Map of pad mount site****Cost Estimate Backup Details**

Cost is based on STORMS estimate, WR number 3399076

Install pad-mounted step transformer – \$407K per site per Work Request estimate, which includes:

- Easement Purchase - \$30K
- Site Work - \$58K
- Environmental Permits - \$26K
- Crane - \$1300
- Flat Bed Truck - \$700

The estimate does not include the 5 MVA padmounted step transformer (\$66K) as this is precapitalized material.

EVERSOURCE
Project Authorization Form

Operations Project Authorization Form

Date Prepared: July 2, 2020	Project Title: Manchester Network Cable Replacement
Company: Eversource NH	Project ID Number: A20C40
Organization: Electric Field Operations	Class(es) of Plant: Distribution
Project Initiator: Robert Krewson	Project Category: Reliability- Network Reliability
Project Manager: Marc Pilotte	Project Type: Specific
Project Sponsor: Russel Johnson	Project Purpose: Replace primary cables in Manchester network
Estimated in service date: 12-31-20	If Transmission Project: PTF? N/A
Eng. /Constr. Resources Budgeted? No	Capital Investment Part of Original Operating Plan? No
Authorization Type: Preliminary Funding	O&M Expenses Part of the Original Operating Plan? No
Total Request: \$148,000	

Financial Requirements:

Project Authorization

ERM: _____

FP&A: _____

Executive Summary

While the network has historically been a highly reliable distribution system due to its inherent redundancy, it has recently experienced a significant number of primary circuit outages. Since December 2018, there have been ten instances of cable or splice failures. The cabling on the four 13.8 kv circuits is primarily PILC (paper insulated, lead covered) cable, and dates to the 1950s.

This initial PAF requests funding for surveying the first of four zones identified for the replacement of primary conductor on all four network circuits. The survey is intended to create a pull plan for circuit cable routing as well as identify in advance issues needing to be addressed during construction.

Additional PAFs will be submitted for subsequent surveys and cable replacement projects.

Full cost of the project is not known at this time but is estimated at approximately \$8 million, and is to be completed over a four year time frame. Total estimated project cost will be revised based on experience as the project proceeds.

EVERSOURCE

Project Authorization Form

Project Costs Summary

Note: Dollar values are in thousands

	Prior Authorized	2020	20__	20__+	Totals
Capital Additions - Direct	\$ -	\$ 117	\$ -	\$ -	\$ 117
Less Customer Contribution	-	-	-	-	-
Removals net of Salvage %	-	-	-	-	-
Total - Direct Spending	\$ -	\$ 117	\$ -	\$ -	\$ 117
Capital Additions - Indirect	-	31	-	-	31
Subtotal Request	\$ -	\$ 148	\$ -	\$ -	\$ 148
AFUDC	-	-	-	-	-
Total Capital Request	\$ -	\$ 148	\$ -	\$ -	\$ 148
O&M	-	-	-	-	-
Total Request	\$ -	\$ 148	\$ -	\$ -	\$ 148

Financial Evaluation

Note: Dollar values are in thousands

Direct Capital Costs	Year 1	Year 2	Year 3+	Total
Straight Time Labor	72			72
Overtime Labor				
Outside Services	45			45
Materials				
Other, including contingency amounts (describe)				
Total Direct Costs	117			117
Indirect Capital Costs	Year 1	Year 2	Year 3+	Total
Indirects/Overheads (including benefits)	31			31
Capitalized interest or AFUDC, if any				
Total Indirect Costs	31			31
Total Capital Costs	148			148
Less Total Customer Contribution				
Total Capital Project Costs	148			148
Total O&M Project Costs				

Note: Explain unique payment provisions, if applicable



Future Financial Impacts:

Provide below the estimated future costs that will result from the project:

Note: Dollar values are in thousands:

Future Costs	Year 20__	Year 20__	Year20__	Year 20__ +	Total Future Project Costs
Capital	\$ -	\$ -	\$ -	\$ -	\$ -
O&M	-	-	-	-	-
Other	-	-	-	-	-
TOTAL	\$ -	\$ -	\$ -	\$ -	\$ -

Describe the estimated future Capital, O&M and/or Other costs noted above:

What functional area(s) will these future costs be funded in? _____

A representative from the respective functional area is required to be included as a project approver.

If this is other than a Reliability Project, please complete the section below:

Provide below the estimated financial benefits that will result from the project:

Note: Dollar values are in thousands:

Future Benefits	Year 20__	Year 20__	Year20__	Year 20__ +	Total Future Project Benefits
Capital	\$ -	\$ -	\$ -	\$ -	\$ -
O&M	-	-	-	-	-
Other	-	-	-	-	-
TOTAL	\$ -	\$ -	\$ -	\$ -	\$ -

Describe the estimated future Capital, O&M and/or Other benefits noted above:

What functional area(s) will these benefits be reflected in? _____

A representative from the respective functional area is required to be included as a project approver.

Asset Retirement Obligation (ARO) and/ or Environmental Cleanup Costs (Environmental Liabilities):

Is there an ARO associated with this project?

Removal of PILC cable does not qualify as an ARO per ES letter from Legal dated January 15, 2020. Footage of removed cable will be tracked (see page 7).

Are there other environmental cleanup costs associated with this project? If yes, please provide details:

None

EVERSOURCE

Project Authorization Form

Technical Justification

Project Need Statement

While the network has historically been a highly reliable distribution system due to its inherent redundancy, it has recently experienced a significant number of primary circuit outages. Since December 2018, there have been ten instances of cable or splice failures. The cabling on the four 13.8 kV circuits is primarily Paper Insulated Lead-sheathed Cable (PILC), and dates to the 1950s.

Hooksett Field Engineering is proposing the replacement of the four network primary circuits due to the poor reliability experienced recently. Construction work is expected to take place over a period of four years. Cable sections recently installed as replacements due to failures will not be replaced.

Project Objectives

Replace the 13A, 13B, 13C, and 13D network primary cables over a four-year period. The project will be broken up into four zones, one per year for the duration of the project, with cable replacements of all four circuits undertaken within each particular zone.

Project Scope

This PAF is to provide funding for a survey of the first of four zones identified for the replacement of primary conductor on all four network circuits. The survey is intended to create a pull plan for circuit cable routing as well as identify in advance issues needing to be addressed during construction. Additional PAFs will be submitted for subsequent surveys and cable replacement projects.

The total project will be to replace approximately 9,000 feet of 13.8 kV 350 mcm PILC mainline network cable circuiting per year for four years.

Additionally, replace approximately 750 feet of 1/0 PILC tap cable feeding the thirty-three network transformers (approximately eight per circuit) as required. It should be noted that some taps were already replaced as part of the network transformer work over the past 15 years.

It is proposed that four modular, disconnectible H-body splices be installed in MH 32A on Elm St. This would allow for a Nutfield Lane circuit to be de-energized for re-conductoring while the remainder of the circuit remains energized from Brook St. This approach could also be adopted while working on Zone 4 by using these same type of splices.

Background / Justification

The network primary cables are 15 KV oil impregnated PILC cables which were installed approximately 60-65 years ago. There are two cable sizes: 350 MCM copper for the mainline, and 1/0 copper for the transformer taps. The original lead cables require specialized lead (transition) splicing to plastic replacement cables. The PILC type cable is very reliable, with failures occurring only when the lead sheath is compromised, which allows water ingress. Historically there have been a limited number of cable failures, and a system of five fault indicators per circuit (designed specifically for PILC application) has enabled quick fault location. Recently there has been an increased rate of primary cable failure, with ten failures since December 2018.

An n-2 contingency during a peak loading period could conceivably require de-energization of the network system to prevent overloading of secondary conductors. Many downtown Manchester customers along Elm St would lose power in this event.

EVERSOURCE

Project Authorization Form

Business Process and / or Technical Improvements:

All network transformers and protectors have been replaced within the last 10-15 years, and major vault restoration has been done as well. Replacement of the aging, increasingly vulnerable primary cables would bring the network system into the 21st century.

Re-racking of primary and secondary cables within the vaults, replacement of broken racks, and other housekeeping needs due to general deterioration would also be accomplished as a result of the primary re-cabling efforts.

Alternatives Considered with Cost Estimates

Address cable failures one at a time as they occur. This increases the overall cost of replacements due to the need to mobilize to respond to a failure and demobilize after replacing that section, until the next failure occurs. This alternative also depends on outages not cascading, which cannot be guaranteed.

Project Schedule

Milestone/Phase Name	Estimated Completion Date
Perform survey of Zone 1 (Nutfield Lane)	8/1/2020
Design Complete for Zone 1	9/15/2020
Start of Zone 1 construction	10/15/2020
Zone 2-4 details to be submitted in a future PAF	

Regulatory Approvals

If necessary, repair of manholes may require permitting by the City of Manchester. There is a moratorium on such construction in the cold weather months and on certain recently repaved streets. All previous "F" manholes (2008 survey) have been repaired except MH 18, which is scheduled for repair in July 2020.

Risks and Risk Mitigation Plans

Certain peak loading periods during the summer may need to be avoided if re-conductoring work requires de-energization of a circuit.

The manhole and duct system in Manchester is quite dated, and there will undoubtedly be issues with plugged conduits and failed racking systems. An additional challenge will be removing and installing circuiting in an environment of tangled cables, which exists in some manholes. Such conditions could certainly escalate the project cost. This risk is being mitigated by performing surveys of each section before beginning work so that these difficulties can be anticipated in advance of actual construction work.

References

None.



Attachments (One-Line Diagrams, Images, etc.)

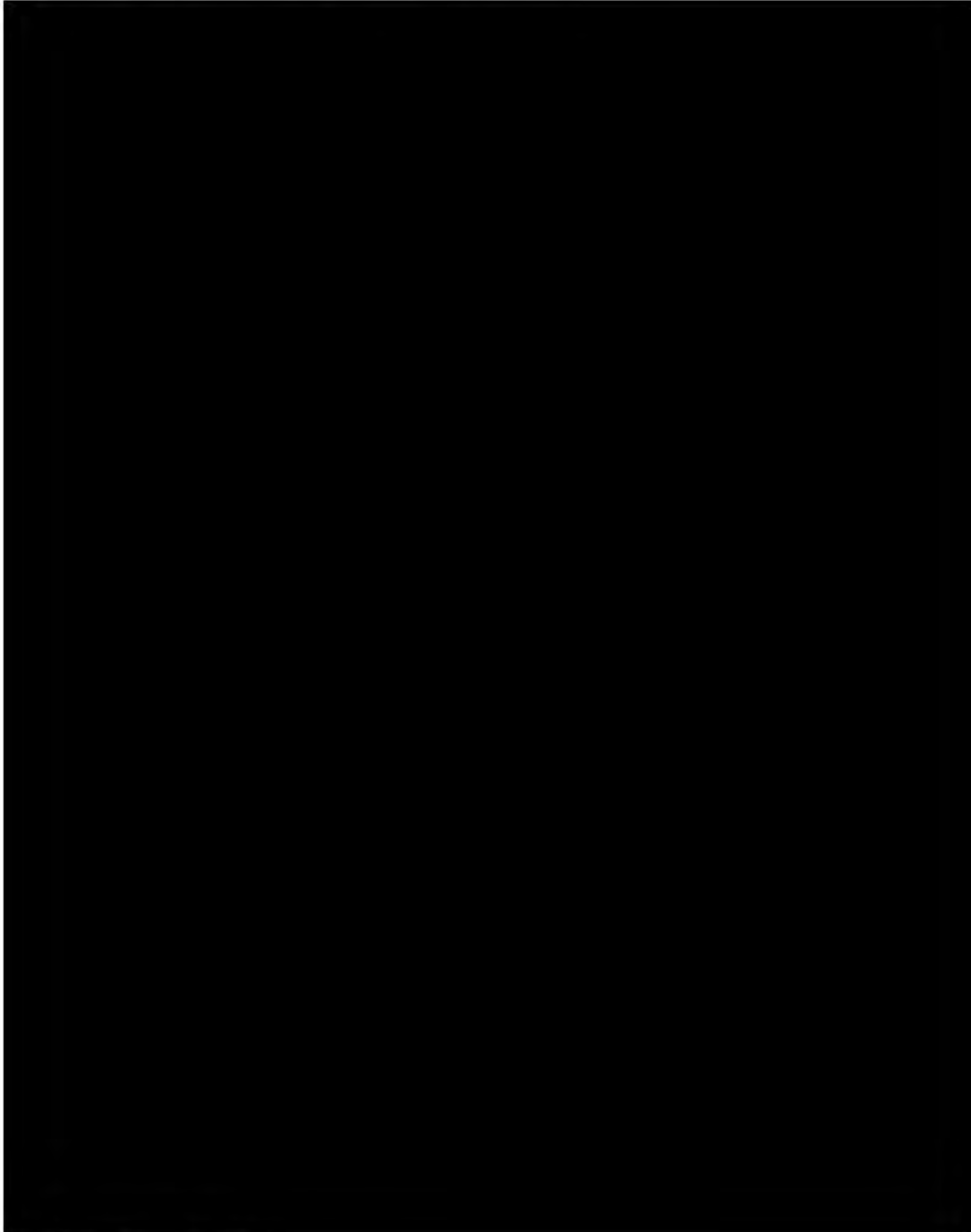

Construction Zones

EVERSOURCE
Project Authorization Form

To: Accounting Files

From: Plant Accounting

Date: 01-15-2020

Subject: Re-examination of whether there is a legal retirement obligation related to the Lead Cable (i.e. PSNH Distribution)

Background: During 2019 Annual ARO review PSNH Distribution engineering team identified replacement of existing lead cable as a potential ARO. According to the PSNH engineering, the full underground network in Manchester is lead cable and it wasn't in the previous versions of ARO review. The cable is not new, and it's been in place for decades.

Upon follow up with our legal department (meeting 12/12/2019) and further discussions - Mike DiPietro, Bob Bersak, Duncan MacKay, it has been determined that there is no legal obligation related to the replacement of the existing lead cable in PSNH as it falls under our regular cable replacement practice.

Historical Treatment: During the original ARO implementation (2005) the lead cable was identified as no ARO.

Conclusion: Lead Cable does not qualify as an ARO.



Operations Project Authorization Form

Date Prepared: 08/31/2020	Project Title: 317 Line ROW section rebuild
Company: Eversource NH	Project Number: A20C46
Organization: Distribution Engineering	Class(es) of Plant: D Line
Project Initiator: Josh Letourneau	Project Category: Lines - ROW
Project Manager: Tom Davis	Project Type: Specific
Project Sponsor: Mark Sandler	Project Purpose: Replace 5000' of ROW line and structures
Estimated in service date: 12-31-2020	Capital Investment part of original Oper. Plan: No
Eng./Constr. Resources Budgeted? Yes	O&M Expenses part of original Oper. Plan: No
Authorization Type: Full Funding	Facility Type (check all that apply): <input type="checkbox"/> PTF <input type="checkbox"/> non-PTF <input checked="" type="checkbox"/> Distribution
Total Request: \$944,000	

Financial Requirements:

Project Authorization

ERM: _____

FP&A: _____

Executive Summary

An approval of \$944K is requested for the line reconstruction of 317 line in right of way between Warner SS and the line crossing at Route 103, approximately 5,000'. Twenty-seven (27) aged wooden poles and deteriorated crossarms will be replaced with new steel structures. In addition to the pole replacements, this project proposes the replacement of 5,000' of 83-year-old #2 copper conductor with 477 MCM spacer cable.

This replacement project will harden the system and provide for future load transfer capabilities. The long-term objective of this project is to complete the 317-line reconstruction in order to provide a backup source to the 316 and 3410 circuits out of North Road Substation. The 316-line feeds 8,757 customers and the 3410 feeds 3,854 customers. Due to the existing limitations on the 317 line, loss of normal feed to North Road Substation would result in approximately 9,000 customers stranded and without power.

This project will also add a neutral to an existing 3 wire system, providing improved fusing protective margins and the eventual removal of the Warner grounding bank.



Project Costs Summary

Note: Dollar values are in thousands

	Prior Authorized	2020	20__	20__+	Totals
Capital Additions - Direct	\$ -	\$590			\$590
Less Customer Contribution	\$ -	\$ -			\$0
Removals net of Salvage %	\$ -	\$ -			\$0
Total - Direct Spending	\$ -	\$590			\$590
Capital Additions - Indirect	\$ -	\$350			\$350
Subtotal Request	\$ -	\$940			\$940
AFUDC	\$ -	\$4			\$4
Total Capital Request	\$ -	\$944			\$944
O&M	\$ -	\$ -			\$ -
Total Request	\$ -	\$944			\$944

Financial Evaluation

Note: Dollar values are in thousands

Direct Capital Costs	Year 1	Year 2	Year 3+	Total
Straight Time Labor	\$20			\$20
Overtime Labor				\$0
Outside Services	\$450			\$450
Materials	\$100			\$100
Other, including contingency amounts (detailed below)	\$20			\$20
Total Direct Costs	\$590	\$0	\$0	\$590

Indirect Capital Costs	Year 1	Year 2	Year 3+	Total
Indirects/Overheads (including benefits)	\$350			\$350
Capitalized interest or AFUDC, if any	\$4			\$4
Total Indirect Costs	\$354	\$0	\$0	\$354

Total Capital Costs	\$944	\$0	\$0	\$944
----------------------------	-------	-----	-----	-------

Less Total Customer Contribution				
----------------------------------	--	--	--	--

Total Capital Project Costs	\$944	\$0	\$0	\$944
------------------------------------	-------	-----	-----	-------

Total O&M Project Costs				
------------------------------------	--	--	--	--

Note: "Other" includes a \$20k contingency for rock excavation for pole setting.



Project Costs Summary

Note: Dollar values are in thousands

Line item Category	Prior Authorized	Actuals to Date	2020 to Go	2021	2022	2023	2024	2025	Total
1. ROW / Easements / Land Acquisition	\$0	\$0	\$0	\$0	\$0	\$0	\$0	\$0	\$0
2. Environmental Approvals / Permits	\$0	\$0	\$2	\$0	\$0	\$0	\$0	\$0	\$2
3. Outreach	\$0	\$0	\$2	\$0	\$0	\$0	\$0	\$0	\$2
4. Siting Approvals / Permits	\$0	\$0	\$2	\$0	\$0	\$0	\$0	\$0	\$2
5. Engineering / Design	\$0	\$0	\$65	\$0	\$0	\$0	\$0	\$0	\$65
6. Materials (Eversource purchased)	\$0	\$0	\$100	\$0	\$0	\$0	\$0	\$0	\$100
7. Construction (incl mat'l's by contractors)	\$0	\$0	\$385	\$0	\$0	\$0	\$0	\$0	\$385
8. Testing / Commissioning	\$0	\$0	\$0	\$0	\$0	\$0	\$0	\$0	\$0
9. Project Mgmt Team	\$0	\$0	\$14	\$0	\$0	\$0	\$0	\$0	\$14
10. Removals	\$0	\$0	\$0	\$0	\$0	\$0	\$0	\$0	\$0
11. Other	\$0	\$0	\$0	\$0	\$0	\$0	\$0	\$0	\$0
12. Risks	\$0	\$0	\$0	\$0	\$0	\$0	\$0	\$0	\$0
SUBTOTAL DIRECTS W/ RISKS	\$0	\$0	\$570	\$0	\$0	\$0	\$0	\$0	\$570
13. Indirects/Overhead	\$0	\$0	\$350	\$0	\$0	\$0	\$0	\$0	\$350
14. AFUDC	\$0	\$0	\$350	\$0	\$0	\$0	\$0	\$0	\$350
PROJECT TOTAL - BASELINE BUDGET	\$0	\$0	\$4	\$0	\$0	\$0	\$0	\$0	\$4
15. Contingency	\$0	\$0	\$924	\$0	\$0	\$0	\$0	\$0	\$924
TOTAL CAPITAL REQUEST	\$0	\$0	\$20	\$0	\$0	\$0	\$0	\$0	\$20
16. Reimbursables/Customer Contribution									
	\$0	\$0	\$944	\$0	\$0	\$0	\$0	\$0	\$944
PROJECT TOTAL (LESS REIMBURSABLES)	\$0	\$0	\$0	\$0	\$0	\$0	\$0	\$0	\$0
O&M									
TOTAL REQUEST	\$0	\$0	\$944	\$0	\$0	\$0	\$0	\$0	\$944

Note: Explain unique payment provisions, if applicable: Provide a detailed breakdown of Other costs here.



Breakout Costs

Note: Dollar values are in thousands

Line item Category	Prior Authorized	Actuals to Date	2020 to Go	2021	2022	2023	2024	2025	Total
ST Labor	\$0	\$0	\$20	\$0	\$0	\$0	\$0	\$0	\$20
OT Labor	\$0	\$0	\$	\$0	\$0	\$0	\$0	\$0	\$
Outside Services Labor	\$0	\$0	\$450	\$0	\$0	\$0	\$0	\$0	\$450
Materials*	\$0	\$0	\$100	\$0	\$0	\$0	\$0	\$0	\$100
Removals	\$0	\$0	\$	\$0	\$0	\$0	\$0	\$0	\$
Other	\$0	\$0	\$20	\$0	\$0	\$0	\$0	\$0	\$20
Indirects	\$0	\$0	\$350	\$0	\$0	\$0	\$0	\$0	\$350
AFUDC	\$0	\$0	\$4	\$0	\$0	\$0	\$0	\$0	\$4
TOTAL CAPITAL REQUEST - W/O REIMBURSABLES	\$0	\$0	\$944	\$0	\$0	\$0	\$0	\$0	\$944

*All materials including Eversource purchased and outside service purchased. Note that outside service purchased material included in construction in project cost summary above.



Future Financial Impacts:

Provide below the estimated future costs that will result from the project:

Note: Dollar values are in thousands

Future Costs	Year 20__	Year 20__	Year 20__	Year 20__ +	Total Future Project Costs
Capital	\$ -	\$ -	\$ -	\$ -	\$ -
O&M	-	-	-	-	-
Other	-	-	-	-	-
TOTAL	\$ -	\$ -	\$ -	\$ -	\$ -

Describe the estimated future Capital, O&M, and/or Other costs noted above:

What functional area(s) will these future costs be funded in? _____

A representative from the respective functional area is required to be included as a project approver.

Provide below the estimated future financial benefits that will result from the project:

Note: Dollar values are in thousands

Future Benefits	Year 20__	Year 20__	Year 20__	Year 20__ +	Total Future Project Benefits
Capital	\$ -	\$ -	\$ -	\$ -	\$ -
O&M	-	-	-	-	-
Other	-	-	-	-	-
TOTAL	\$ -	\$ -	\$ -	\$ -	\$ -

Describe the estimated future Capital, O&M, and/or Other benefits noted above:

What functional area(s) will these benefits be reflected in? _____

A representative from the respective functional area is required to be included as a project approver.

Asset Retirement Obligation (ARO) and/ or Environmental Cleanup Costs (Environmental Liabilities):

Is there an ARO associated with this project? If yes, please provide details: No

Are there other environmental cleanup costs associated with this project? If yes, please provide details:

None.



Technical Justification

Project Need Statement

NH Operations, has identified structures on the 317 Line (Structure 317/971 and ending at structure 317/945, between West Main St. and School St., Warner, NH) that are in need of replacement through the use of foot and aerial patrols. Proposed is the replacement of twenty-seven (27) structures on this line which consist mostly of original wood structures in the town of Warner. All twenty-seven (27) structures will be replaced with light duty self-weathering steel. The majority of the structures proposed for replacement were constructed in 1937 and are therefore over 83 years old. The structures have one or more of the following deficiencies: deteriorated cross-arms, pole & shell deterioration & bent insulator pins.

In addition to the pole replacements, this project will replace approximately 5,000' of #2 copper conductor with 477 MCM spacer cable. This conductor was installed in 1937 and due to the age and service life is assumed to be annealed and brittle. It cannot be safely handled energized by line crews.

These issues noted above jeopardize the long-term integrity, electrical integrity and the continued reliability of the 317 line. To ensure the continued operability of this line, the structures on this line need to be replaced.

Project Objectives

- Proactive approach to system reliability
- Reduce the occurrence of unplanned outages which may require the need for emergency structure replacement
- Minimize impact to customers and ROW abutters under normal conditions and emergency conditions
- Minimize the duration of unforeseen outages due to establishing access roads.

Project Scope

27 poles to be replaced with self-weathering steel
 5,000' of conductor to be replaced with 477 MCM spacer cable
 5,000' of 127 AWA messenger to be installed which will add a neutral to an existing 3 wire system

Background / Justification

The 317 line was constructed in 1937 and is 34.5 kV. The line is of a three-wire system of #2 copper conductor with no neutral (See System Operations justification). The #2 copper conductor is original from when the line was constructed in 1937 (see first picture in Attachment A, showing date nail on an existing pole). This conductor has become annealed during its lifespan due to loading and fault currents. In some locations, the wire has been stretched from previous tree impacts and can present challenges when splicing. Much of the pole top construction consists of original build, including crossarms (see Attachment A) & insulators, many of which are the original pin and cap insulators. Recent field inspections show significant deterioration to above ground pole, crossarm, and insulator condition. High resolution photographs of some structures are provided in Attachment A.

The new structures will be light duty self-weathering steel which provides a much greater life expectancy than wood and a higher storm resiliency than wood.



Reliability

This replacement project will harden the system and provide for future load transfer capabilities. The long-term objective of this project is to complete the 317-line reconstruction to provide a backup source to the 316 and 3410 circuits out of North Road Substation. The 316-line feeds 8,757 customers. The 3410 feeds 3,854 customers. This project will also add a neutral to an existing 3 wire system, providing improved fusing protective margins and the eventual removal of the Warner grounding bank.

System operations

This section of 317 line is comprised of #2 solid copper with no system neutral. Engineering burndown curves show that a 30T fuse would be needed to clear the line to prevent conductor burndown. This fuse limitation restricts higher fuse sizes on side taps and eventually results in some P&C coordination issues. Additionally, there is a ground bank located in the Warner section of the line due to the lack of a system neutral. This also limits system protection for line to ground fault protection.

Load transfer capability on this section of line is limited to 16.7 MW in the summer and 20.6 MW in the winter. In reality, before the thermal limit is reached, voltage levels will fall below acceptable levels. Installing standard per phase line regulators and capacitor banks can't be accomplished due to the lack of a system neutral. Currently, we reach thermal and voltage limits when trying to reroute power from North Road 316 & 3140 circuits to the 317 line. The customer impact for these two lines is 12,631 customers.

The completed 317-line full line rebuild will allow for a greater transfer capability into the greater I-89 corridor of circuits and provide better reliability to Eversource customers on these circuits. Additionally, System protection will be enhanced by installing a system neutral which would allow additional protection coordination with larger protective settings and increased protective margins on the downstream circuitry.

Business Process and / or Technical Improvements

Replacement of aged structures and conductor with new materials.

Alternatives Considered with Cost Estimates

1. Do nothing

This alternative was not chosen because it does not address the condition deficiencies associated with this line portion and the impact on system reliability or resiliency.

2. Replace Only Deteriorated Components

This will address the concern of individual component reliability but will reuse remaining parts of the structure. Due to the age of these poles (approximately eighty-five years), it is likely that many of these poles will also have to be replaced in the near future. This would result in additional line outages, environmental impact, and repeating the work of removing / installing the crossarm. In addition, replacement of an entire structure is more efficient as the new structure is installed next to the existing, and wires transferred. This reduces the cost of having to temporarily support wires and can result in reduced restoral time. This would also not address the clearance issues. As a result, this alternative was not selected. This option also does not address the lack of a system-neutral or the brittle and annealed #2 copper primary conductor.



3. Replace Only Structures with Deteriorated Components

This alternative will address the concern of near-term reliability but not the line rating evaluation or future reliability. Addressing these issues with independent future projects would involve additional environmental and siting reviews and permitting. As a result, this alternative was not selected. This option also does not address the lack of a system-neutral or the brittle and annealed #2 primary conductor.

Project Schedule

Milestone/Phase Name	Estimated Date
100% Engineering Completion	Sep 22, 2020
Construction Start	Oct 1, 2020
In Service Date	Dec 1, 2020

Regulatory Approvals

None.

Risks and Risk Mitigation Plans

- Although preliminary walkdowns have been conducted, if the project bid prices are higher than anticipated, supplemental authorization will be sought.
- Wetlands mapping has been completed for this line in advance to ensure permitting approval for the start of the construction.
- The majority of this work will be completed in live line conditions minimizing the need for planned outages.
- The improved ROW access and roadways will increase public access to these locations. To minimize risk to the public, gates will be installed at access locations as required.

Contingency

Usage	Amount
Unanticipated rock excavation	\$20K
TOTAL	\$20K

References

None.

Attachments (One-Line Diagrams, Images, etc.)

Attachment A - 317 Line – Structure Pictures



Attachment A – Structure pictures and conditions

- **Date nail indicating pole install in 1937**





- Cross arm deteriorated, insulator pin bent





- Cross arm deterioration





- Cross arm, pole top, pin and cap insulators



EVERSOURCE
Project Authorization Form

- Pole, shell deteriorated





- Pole, shell deteriorated



EVERSOURCE
Project Authorization Form

- Pole deteriorated





Operations Project Authorization Form

Date Prepared: 10/23/2020	Project Title: Codfish Corner Road Loop
Company: Eversource NH	Project Number: A20E47
Organization: Distribution Engineering	Class(es) of Plant: D Line
Project Initiator: Paul Grace	Project Category: Lines - UG Cable
Project Manager: Michael Busby	Project Type: Specific
Project Sponsor: Paul Renaud	Project Purpose: Replace Live Front and Add Loop Feed
Estimated in service date: 3/31/2021	Capital Investment part of original Oper. Plan: No
Eng./Constr. Resources Budgeted? No	O&M Expenses part of original Oper. Plan: No
Authorization Type: Full Funding	Facility Type (check all that apply):
Total Request: \$469,000	<input type="checkbox"/> PTF <input type="checkbox"/> non-PTF <input checked="" type="checkbox"/> Distribution

Financial Requirements:

Project Authorization

ERM: _____

FP&A: _____

Executive Summary

This PAF requests \$469,000 to replace failed direct buried URD cable with new cable in conduit.

This project restores the failed direct buried loop on Codfish Corner Road in Portsmouth on the 3105X1 circuit. The current loop is not in service as it is direct buried and the cable between riser pole 169/9Y and T7 has failed. This project would also replace an existing 75 kVA live-front transformer with a new 100 kVA transformer and replaces a 25 kVA transformer with a 100 kVA transformer. The project installs approximately 1,850 feet of parallel 3" primary conduit and a 1/0 XLP single phase cable along with two splice boxes. This would bring an existing 107 customer underground loop back into service. It will also remove an abandoned primary overhead wire that currently passes directly over a customer's mobile home and one pole located in a customer's backyard.



Project Costs Summary

Note: Dollar values are in thousands

Line item Category	Prior Authorized	Actuals to Date	2020 to Go	2021	2022	2023	2024	2025	Total
1. ROW / Easements / Land Acquisition	\$0	\$0	\$0	\$0	\$0	\$0	\$0	\$0	\$0
2. Environmental Approvals / Permits	\$0	\$0	\$0	\$0	\$0	\$0	\$0	\$0	\$0
3. Outreach	\$0	\$0	\$0	\$0	\$0	\$0	\$0	\$0	\$0
4. Siting Approvals / Permits	\$0	\$0	\$0	\$0	\$0	\$0	\$0	\$0	\$0
5. Engineering / Design	\$0	\$0	\$0	\$0	\$0	\$0	\$0	\$0	\$0
6. Materials (Eversource purchased)	\$0	\$0	\$6	\$0	\$0	\$0	\$0	\$0	\$6
7. Construction (incl mat'l's by contractors)	\$0	\$0	\$246	\$0	\$0	\$0	\$0	\$0	\$246
8. Testing / Commissioning	\$0	\$0	\$0	\$0	\$0	\$0	\$0	\$0	\$0
9. Project Mgmt Team	\$0	\$0	\$0	\$0	\$0	\$0	\$0	\$0	\$0
10. Removals	\$0	\$0	\$13	\$0	\$0	\$0	\$0	\$0	\$13
11. Other	\$0	\$0	\$0	\$0	\$0	\$0	\$0	\$0	\$0
12. Risks	\$0	\$0	\$0	\$0	\$0	\$0	\$0	\$0	\$0
SUBTOTAL DIRECTS W/ RISKS	\$0	\$0	\$264	\$0	\$0	\$0	\$0	\$0	\$264
13. Indirects/Overhead	\$0	\$0	\$204	\$0	\$0	\$0	\$0	\$0	\$204
14. AFUDC	\$0	\$0	\$1	\$0	\$0	\$0	\$0	\$0	\$1
PROJECT TOTAL - BASELINE BUDGET	\$0	\$0	\$469	\$0	\$0	\$0	\$0	\$0	\$469
15. Contingency	\$0	\$0	\$0	\$0	\$0	\$0	\$0	\$0	\$0
TOTAL CAPITAL REQUEST	\$0	\$0	\$469	\$0	\$0	\$0	\$0	\$0	\$469
16. Reimbursables/Customer Contribution	\$0	\$0	\$0	\$0	\$0	\$0	\$0	\$0	\$0
PROJECT TOTAL (LESS REIMBURSABLES)	\$0	\$0	\$469	\$0	\$0	\$0	\$0	\$0	\$469
O&M	\$0	\$0	\$0	\$0	\$0	\$0	\$0	\$0	\$0
TOTAL REQUEST	\$0	\$0	\$469	\$0	\$0	\$0	\$0	\$0	\$469

Note: Explain unique payment provisions, if applicable: Provide a detailed breakdown of Other costs here.



Breakout Costs

Note: Dollar values are in thousands

Line item Category	Prior Authorized	Actuals to Date	2020 to Go	2021	2022	2023	2024	2025	Total
ST Labor	\$0	\$0	\$0	\$0	\$0	\$0	\$0	\$0	\$0
OT Labor	\$0	\$0	\$0	\$0	\$0	\$0	\$0	\$0	\$0
Outside Services Labor	\$0	\$0	\$246	\$0	\$0	\$0	\$0	\$0	\$246
Materials*	\$0	\$0	\$6	\$0	\$0	\$0	\$0	\$0	\$6
Removals	\$0	\$0	\$13	\$0	\$0	\$0	\$0	\$0	\$13
Other	\$0	\$0	\$0	\$0	\$0	\$0	\$0	\$0	\$0
Indirects	\$0	\$0	\$204	\$0	\$0	\$0	\$0	\$0	\$204
AFUDC	\$0	\$0	\$1	\$0	\$0	\$0	\$0	\$0	\$1
TOTAL CAPITAL REQUEST - W/O REIMBURSABLES	\$0	\$0	\$469	\$0	\$0	\$0	\$0	\$0	\$469

*All materials including Eversource purchased and outside service purchased. Note that outside service purchased material included in construction in project cost summary above.

Outside Services: \$215,000 for civil work plus \$82,000 for electrical work (includes installations and removals). \$38,000 of contractor cost is expense.

Bid Prices	
Civil work	\$215,000
Electrical Work	\$82,000
O&M	(\$38,000)
Total capital O.S.	\$259,000

Budgeted cost	
Outside Services	\$246,000
Removals	\$13,000
Total	\$259,000



Future Financial Impacts:

Provide below the estimated future costs that will result from the project:

Note: Dollar values are in thousands

Future Costs	Year 20__	Year 20__	Year 20__	Year 20__ +	Total Future Project Costs
Capital	\$ -	\$ -	\$ -	\$ -	\$ -
O&M	-	-	-	-	-
Other	-	-	-	-	-
TOTAL	\$ -	\$ -	\$ -	\$ -	\$ -

Describe the estimated future Capital, O&M, and/or Other costs noted above:

What functional area(s) will these future costs be funded in? _____
A representative from the respective functional area is required to be included as a project approver.

Provide below the estimated future financial benefits that will result from the project:

Note: Dollar values are in thousands

Future Benefits	Year 20__	Year 20__	Year 20__	Year 20__ +	Total Future Project Benefits
Capital	\$ -	\$ -	\$ -	\$ -	\$ -
O&M	-	-	-	-	-
Other	-	-	-	-	-
TOTAL	\$ -	\$ -	\$ -	\$ -	\$ -

Describe the estimated future Capital, O&M, and/or Other benefits noted above:

What functional area(s) will these benefits be reflected in? _____
A representative from the respective functional area is required to be included as a project approver.

Asset Retirement Obligation (ARO) and/ or Environmental Cleanup Costs (Environmental Liabilities):

Is there an ARO associated with this project? If yes, please provide details: No

Are there other environmental cleanup costs associated with this project? If yes, please provide details: No



Technical Justification

Project Need Statement

The 3105X1 at the Portsmouth Trailer Park has a failed section of direct buried cable on Codfish Corner Road. This project installs conduit and primary cable to restore loop feed of the 107 customers in this section of the trailer park. This loop will allow for the removal of overhead abandoned primary that spans directly over customers home. This project also replaces a 75 kVA live-front transformer with a new 100 kVA transformer and replaces a 25 kVA transformer with a 100 kVA transformer.

Project Objectives

- Eliminate obsolete live-front transformers.
- Restore a loop feed for 107 customers in the Portsmouth Trailer Park.
- Remove abandoned overhead line and backyard construction that spans over a customer's home.

Project Scope

Replace failed direct buried cable on the 3105X1 and put the Portsmouth Trailer Park loop back into service. Install 1,850 feet of underground single phase 1/0 XLP cable in conduit between transformers 146/134T2 and 146/134T7 and between transformers 146/134T2A and 146/134T3 to restore loop. Remove overhead out of service riser from customers backyard. Install a new dead-front transformer and removes 75 kVA live front transformer (146/134T2). It also replaces a second live-front transformer (146/134T3) to help complete loop and allow switching without having to de-energize customers.

Background / Justification

The Portsmouth Trailer Park is fed from the 3105X1. It was built with a direct buried loop that is out of service because of a cable failure. 107 customers are at risk with no loop to provide a backup should anything fail. This project would replace direct buried cable with cable in conduit and restore an out of service loop. It would also replace an obsolete live-front transformer.

Business Process and / or Technical Improvements

Replaces failed direct buried cable with cable in conduit to allow restoration of service should the existing radial feed fail. This also reduces the Company's inventory of direct buried cable.

Alternatives Considered with Cost Estimates

The alternate consideration would be to splice the failed direct buried cable and use existing out of service riser. This is not possible as the riser and direct buried cable are on private property with no easement and customer will not allow rebuild as wire spans over their home which is a violation of the NESC in its current state.

Project Schedule

Milestone/Phase Name	Estimated Date
100% Engineering Completion	9/11/2020
Construction Start	3/1/2021
In Service Date	5/1/2021

REDACTED

EVERSOURCE
Project Authorization Form

Regulatory Approvals

None.

Risks and Risk Mitigation Plans

None identified.

Contingency

None.

References

Attachments (One-Line Diagrams, Images, etc.)



Cost Estimate Backup Details

The cost estimate for this project came is based on a STORMS estimate (#2991789) and contractor bids for civil work (\$215,000) and electrical work (\$82,000).



Operations Project Authorization Form

Date Prepared: 09/14/2020	Project Title: Foundry Place Switchgear
Company: Eversource NH	Project Number: A20E48
Organization: Distribution Engineering	Class(es) of Plant: D Line
Project Initiator: Paul Grace	Project Category: Lines - UG Cable
Project Manager: Michael Busby	Project Type: Specific
Project Sponsor: Paul Renaud	Project Purpose: Extend Backbone by Adding a Switchgear
Estimated in service date: 12/31/2020	Capital Investment part of original Oper. Plan: No
Eng./Constr. Resources Budgeted? Yes	O&M Expenses part of original Oper. Plan: No
Authorization Type: Full Funding	Facility Type (check all that apply):
Total Request: \$290,400	<input type="checkbox"/> PTF <input type="checkbox"/> non-PTF <input checked="" type="checkbox"/> Distribution

Financial Requirements:

Project Authorization

ERM: _____

FP&A: _____

Executive Summary

This project installs a new switchgear and approximately 2,400 feet of new underground primary cable on Foundry Place in Portsmouth NH. In 2018, the City of Portsmouth created the street Foundry Place and built a new 5-story parking garage. The city also installed four electrical manholes and associated conduit at no cost to Eversource in order to extend underground electrical service to Foundry Place. This project will extend the 15W4 underground primary to the new switchgear to serve the new parking garage and several new multi-story residential/mix use buildings on Foundry place and Deer Street. The construction of the new buildings was delayed due to COVID-19, but the first building is now scheduled to break ground in November 2020. The new Switchgear will be utilized to create loops with the existing switchgear #2 and #12.

This PAF is based on a "Not To Exceed" (NTX) bid from contractors and replaces the previously approved PAF which was based on a STORMS estimate.



Project Costs Summary

Note: Dollar values are in thousands

Line item Category	Prior Authorized	Actuals to Date	2020 to Go	2021	2022	2023	2024	2025	Total
1. ROW / Easements / Land Acquisition	\$	\$	\$0	\$	\$	\$	\$	\$	\$0
2. Environmental Approvals / Permits	\$	\$	\$0	\$	\$	\$	\$	\$	\$0
3. Outreach	\$	\$	\$0	\$	\$	\$	\$	\$	\$0
4. Siting Approvals / Permits	\$	\$	\$0	\$	\$	\$	\$	\$	\$0
5. Engineering / Design	\$	\$	\$0	\$	\$	\$	\$	\$	\$0
6. Materials (Eversource purchased)	\$	\$	\$130.8	\$	\$	\$	\$	\$	\$130.8
7. Construction (incl mat's by contractors)	\$	\$	\$89.2	\$	\$	\$	\$	\$	\$89.2
8. Testing / Commissioning	\$	\$	\$0	\$	\$	\$	\$	\$	\$0
9. Project Mgmt Team	\$	\$	\$0	\$	\$	\$	\$	\$	\$0
10. Removals	\$	\$	\$0	\$	\$	\$	\$	\$	\$0
11. Other	\$	\$	\$0	\$	\$	\$	\$	\$	\$0
12. Risks	\$	\$	\$0	\$	\$	\$	\$	\$	\$0
SUBTOTAL DIRECTS W/ RISKS	\$	\$	\$220	\$	\$	\$	\$	\$	\$220
13. Indirects/Overhead	\$	\$	69.5	\$	\$	\$	\$	\$	69.5
14. AFUDC	\$	\$	\$0.9	\$	\$	\$	\$	\$	\$0.9
PROJECT TOTAL – BASELINE BUDGET	\$	\$	\$290.4	\$	\$	\$	\$	\$	\$290.4
15. Contingency	\$	\$	\$	\$	\$	\$	\$	\$	\$
TOTAL CAPITAL REQUEST	\$	\$	\$290.4	\$	\$	\$	\$	\$	\$290.4
16. Reimbursables/Customer Contribution	\$	\$	\$	\$	\$	\$	\$	\$	\$
PROJECT TOTAL (LESS REIMBURSABLES)	\$	\$	\$290.4	\$	\$	\$	\$	\$	\$290.4
O&M	\$	\$	\$	\$	\$	\$	\$	\$	\$
TOTAL REQUEST	\$	\$	\$290.4	\$	\$	\$	\$	\$	\$290.4

Note: Explain unique payment provisions, if applicable: Provide a detailed breakdown of Other costs here.



Breakout Costs

Note: Dollar values are in thousands

Line item Category	Prior Authorized	Actuals to Date	2020 to Go	2021	2022	2023	2024	2025	Total
ST Labor	\$	\$	\$	\$	\$	\$	\$	\$	\$
OT Labor	\$	\$	\$	\$	\$	\$	\$	\$	\$
Outside Services Labor	\$	\$	\$89.2	\$	\$	\$	\$	\$	\$89.2
Materials*	\$	\$	\$130.8	\$	\$	\$	\$	\$	\$130.8
Removals	\$	\$	\$	\$	\$	\$	\$	\$	\$
Other	\$	\$	\$	\$	\$	\$	\$	\$	\$
Indirects	\$	\$	\$69.5	\$	\$	\$	\$	\$	\$69.5
AFUDC	\$	\$	\$0.9	\$	\$	\$	\$	\$	\$0.9
TOTAL CAPITAL REQUEST - W/O REIMBURSABLES	\$	\$	\$290.4	\$	\$	\$	\$	\$	\$290.4

*All materials including Eversource purchased and outside service purchased. Note that outside service purchased material included in construction in project cost summary above.



Future Financial Impacts:

Provide below the estimated future costs that will result from the project:

Note: Dollar values are in thousands

Future Costs	Year 20__	Year 20__	Year 20__	Year 20__ +	Total Future Project Costs
Capital	\$ -	\$ -	\$ -	\$ -	\$ -
O&M	-	-	-	-	-
Other	-	-	-	-	-
TOTAL	\$ -	\$ -	\$ -	\$ -	\$ -

Describe the estimated future Capital, O&M, and/or Other costs noted above:

What functional area(s) will these future costs be funded in? _____
A representative from the respective functional area is required to be included as a project approver.

Provide below the estimated future financial benefits that will result from the project:

Note: Dollar values are in thousands

Future Benefits	Year 20__	Year 20__	Year 20__	Year 20__ +	Total Future Project Benefits
Capital	\$ -	\$ -	\$ -	\$ -	\$ -
O&M	-	-	-	-	-
Other	-	-	-	-	-
TOTAL	\$ -	\$ -	\$ -	\$ -	\$ -

Describe the estimated future Capital, O&M, and/or Other benefits noted above:

What functional area(s) will these benefits be reflected in? _____
A representative from the respective functional area is required to be included as a project approver.

Asset Retirement Obligation (ARO) and/ or Environmental Cleanup Costs (Environmental Liabilities):

Is there an ARO associated with this project? No

Are there other environmental cleanup costs associated with this project? No.



Technical Justification

Project Need Statement

In 2018 the city of Portsmouth created the road Foundry Place and built a 5-story parking garage. The city has approved plans for several new 5-story buildings on this street and installed 4 manholes, a duct bank between the manholes and pads for transformers for the expansion on the street. The new buildings have been delayed because of COVID-19, but one of the new buildings is expected to break ground in November 2020. The 15W4 has existing manholes and a duct bank ready for the switchgear and cable to be installed. This switchgear would add to the backbone of the underground 15W4 in downtown Portsmouth to connect Switchgear #12, Switchgear #2 and the new Switchgear #19. This will provide a backup for currently radially fed transformers and future additions by creating a loop between Switchgear #19 and #12 and adding a spare load port for the area.

Project Objectives

- Add 2400 feet of primary and a switchgear to the 15W4 backbone from Switchgear #12 to the new Switchgear #19 and to Switchgear #2.
- Create a loop for existing radially fed transformers and future additions between load ports on Switchgear #19 and #12.
- Install a Switchgear for load growth in downtown Portsmouth.

Project Scope

Install 2400 feet of backbone primary into the existing manhole and duct bank system in order to add another switchgear to the 15W4. The switchgear will cut in between Switchgear #2 and #12 and create a load port loop with Switchgear #12 and add a spare load port to downtown Portsmouth. To do this primary will be run through existing conduits that connect MH16, MH17, MH18 and MH19. It will create a loop for radially fed transformers and incoming customers, as well as adding another switching point for the downtown Portsmouth underground system.

Background / Justification

Foundry Place is a newly created road with a 5-story parking garage that was built in 2018 and plans were accepted for two additional 5-story buildings on the street. A manhole and duct bank system were installed along this street to add a switchgear into the underground system, but the cable and switchgear have not been installed yet. The switchgear would extend the backbone of the 15W4, add a switching point for the underground system, create a backup for existing radially fed customers and create a backup for the new buildings that are going to be built on this street.

Business Process and / or Technical Improvements

Provides improved switching capabilities to the downtown Portsmouth underground system.

Alternatives Considered with Cost Estimates

The alternative would be to tie in the new switchgear with switchgear 2. This project would require about 2600 feet of primary in the existing manhole and duct bank system. This project is less favorable because it would require an additional 200 feet of underground primary cable.

Project Schedule

Milestone/Phase Name	Estimated Date
100% Engineering Completion	9/14/2020
Construction Start	10/5/2020

REDACTED

EVERSOURCE
Project Authorization Form

Milestone/Phase Name	Estimated Date
Testing/Commissioning	
In Service Date	10/31/2020

Regulatory Approvals

None.

Risks and Risk Mitigation Plans

None identified.

Contingency

None.

References

Attachments (One-Line Diagrams, Images, etc.)

Downtown Portsmouth:

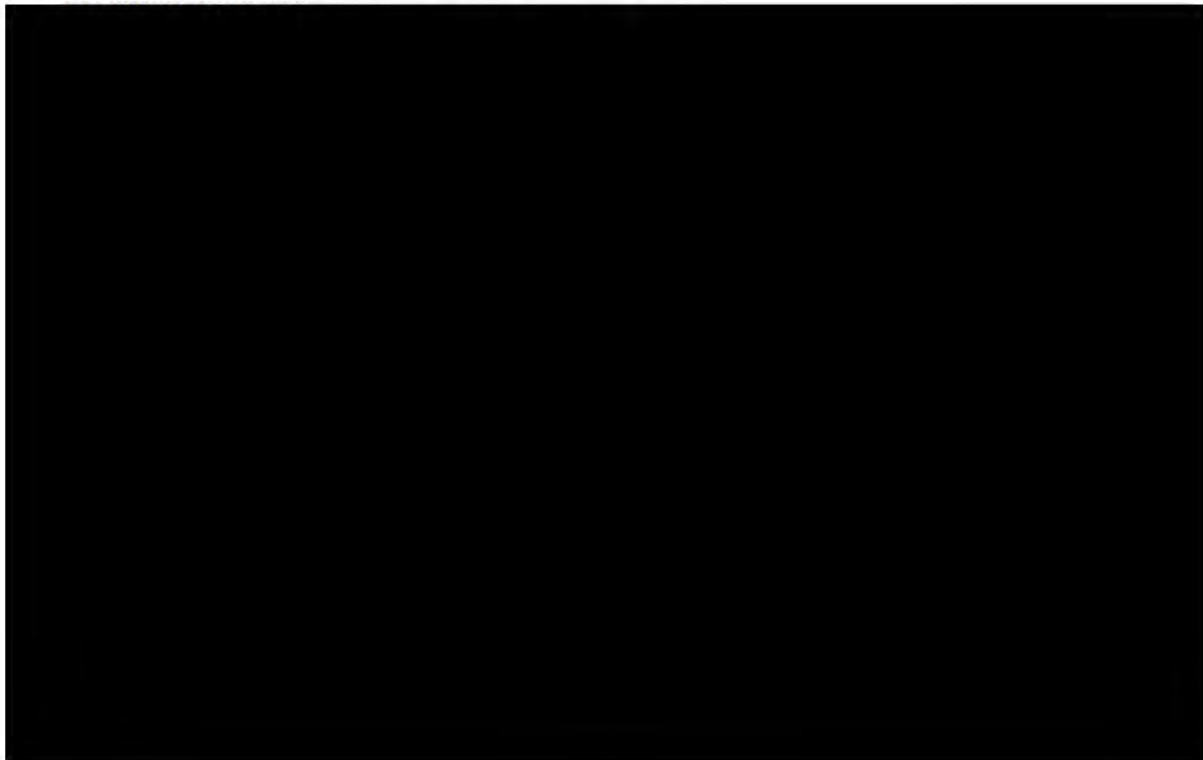

REDACTED

EVERSOURCE

Project Authorization Form

Foundry Place:

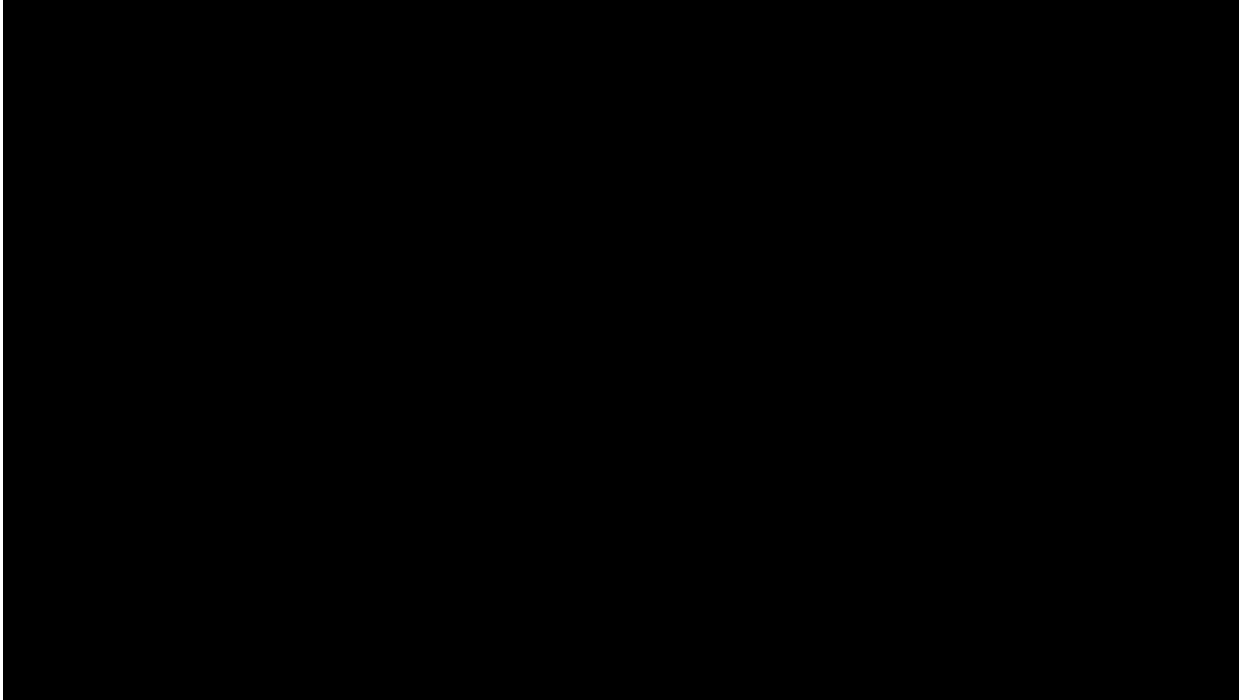

Proposed Switchgear Location:



Cost Estimate Backup Details

This project cost was estimated using STORMS and NTX contractor cost of \$89,180.



Operations Project Authorization Form

Date Prepared: 10/19/2020	Project Title: NHDOT Line Relocation, Route 106 Loudon
Company: Eversource NH	Project Number: A20N50
Organization: Distribution Engineering	Class(es) of Plant: D Line
Project Initiator: Dave Simkins	Project Category: Lines - General
Project Manager: Tom Kane	Project Type: Specific
Project Sponsor: Russel Johnson	Project Purpose: Relocate line for NHDOT
Estimated in service date: 12/30/2020	Capital Investment part of original Oper. Plan: No
Eng./Constr. Resources Budgeted? Yes	O&M Expenses part of original Oper. Plan: No
Authorization Type: Full Funding	Facility Type (check all that apply):
Total Request: \$366,000	<input type="checkbox"/> PTF <input type="checkbox"/> non-PTF <input checked="" type="checkbox"/> Distribution

Financial Requirements:

Project Authorization

ERM: _____

FP&A: _____

Executive Summary

This request is for \$366,000 to relocate exiting lines along Route 106 in Loudon, NH at the request of the NH Department of Transportation.

The NHDOT has a road widening project, #29613-A, along Route 106 in Loudon and Canterbury, NH. This requires Eversource to relocate approximately 6,900 feet of existing three phase overhead line in accordance with pole licensing requirements and State of NH RSAs.

Project Costs Summary *Note: Dollar values are in thousands*

Line item Category	Prior Authorized	Actuals to Date	2020 to Go	2021	2022	2023	2024	2025	Total
1. ROW / Easements / Land Acquisition	\$0	\$0	\$0	\$0	\$0	\$0	\$0	\$0	\$0
2. Environmental Approvals / Permits	\$0	\$0	\$0	\$0	\$0	\$0	\$0	\$0	\$0
3. Outreach	\$0	\$0	\$0	\$0	\$0	\$0	\$0	\$0	\$0
4. Siting Approvals / Permits	\$0	\$0	\$0	\$0	\$0	\$0	\$0	\$0	\$0
5. Engineering / Design	\$0	\$0	\$15	\$0	\$0	\$0	\$0	\$0	\$15
6. Materials (Eversource purchased)	\$0	\$0	\$58	\$0	\$0	\$0	\$0	\$0	\$58
7. Construction (incl matl's by contractors)	\$0	\$0	\$145	\$0	\$0	\$0	\$0	\$0	\$145
8. Testing / Commissioning	\$0	\$0	\$0	\$0	\$0	\$0	\$0	\$0	\$0
9. Project Mgmt Team	\$0	\$0	\$0	\$0	\$0	\$0	\$0	\$0	\$0
10. Removals	\$0	\$0	\$0	\$0	\$0	\$0	\$0	\$0	\$0
11. Other	\$0	\$0	\$0	\$0	\$0	\$0	\$0	\$0	\$0
12. Risks	\$0	\$0	\$0	\$0	\$0	\$0	\$0	\$0	\$0
SUBTOTAL DIRECTS W/ RISKS	\$0	\$0	\$218	\$0	\$0	\$0	\$0	\$0	\$218
13. Indirects/Overhead	\$0	\$0	\$138	\$0	\$0	\$0	\$0	\$0	\$138
14. AFUDC	\$0	\$0	\$0	\$0	\$0	\$0	\$0	\$0	\$0
PROJECT TOTAL - BASELINE BUDGET	\$0	\$0	\$356	\$0	\$0	\$0	\$0	\$0	\$356
15. Contingency	\$0	\$0	\$10	\$0	\$0	\$0	\$0	\$0	\$10
TOTAL CAPITAL REQUEST	\$0	\$0	\$366	\$0	\$0	\$0	\$0	\$0	\$366
16. Reimbursables/Customer Contribution	\$0	\$0	\$0	\$0	\$0	\$0	\$0	\$0	\$0
PROJECT TOTAL (LESS REIMBURSABLES)	\$0	\$0	\$366	\$0	\$0	\$0	\$0	\$0	\$366
O&M	\$0	\$0	\$0	\$0	\$0	\$0	\$0	\$0	\$0
TOTAL REQUEST	\$0	\$0	\$366	\$0	\$0	\$0	\$0	\$0	\$366

Note: Explain unique payment provisions, if applicable: *Provide a detailed breakdown of Other costs here.*



Breakout Costs

Note: Dollar values are in thousands

Line item Category	Prior Authorized	Actuals to Date	2020 to Go	2021	2022	2023	2024	2025	Total
ST Labor	\$0	\$0	\$30	\$0	\$0	\$0	\$0	\$0	\$30
OT Labor	\$0	\$0	\$0	\$0	\$0	\$0	\$0	\$0	\$0
Outside Services Labor	\$0	\$0	\$130	\$0	\$0	\$0	\$0	\$0	\$130
Materials*	\$0	\$0	\$58	\$0	\$0	\$0	\$0	\$0	\$58
Removals	\$0	\$0	\$0	\$0	\$0	\$0	\$0	\$0	\$0
Other	\$0	\$0	\$10	\$0	\$0	\$0	\$0	\$0	\$10
Indirects	\$0	\$0	\$138	\$0	\$0	\$0	\$0	\$0	\$138
AFUDC	\$0	\$0	\$0	\$0	\$0	\$0	\$0	\$0	\$0
TOTAL CAPITAL REQUEST - W/O REIMBURSABLES	\$0	\$0	\$366	\$0	\$0	\$0	\$0	\$0	\$366

*All materials including Eversource purchased and outside service purchased. Note that outside service purchased material included in construction in project cost summary above.

A contingency of \$10,000 is shown under "Other" and is to account for the possibility of ledge encountered during pole setting.



Future Financial Impacts:

Provide below the estimated future costs that will result from the project:

Note: Dollar values are in thousands

Future Costs	Year 20__	Year 20__	Year 20__	Year 20__ +	Total Future Project Costs
Capital	\$ -	\$ -	\$ -	\$ -	\$ -
O&M	-	-	-	-	-
Other	-	-	-	-	-
TOTAL \$	-	\$ -	\$ -	\$ -	\$ -

Describe the estimated future Capital, O&M, and/or Other costs noted above:

What functional area(s) will these future costs be funded in? _____

A representative from the respective functional area is required to be included as a project approver.

Provide below the estimated future financial benefits that will result from the project:

Note: Dollar values are in thousands

Future Benefits	Year 20__	Year 20__	Year 20__	Year 20__ +	Total Future Project Benefits
Capital	\$ -	\$ -	\$ -	\$ -	\$ -
O&M	-	-	-	-	-
Other	-	-	-	-	-
TOTAL \$	-	\$ -	\$ -	\$ -	\$ -

Describe the estimated future Capital, O&M, and/or Other benefits noted above:

What functional area(s) will these benefits be reflected in? _____

A representative from the respective functional area is required to be included as a project approver.

Asset Retirement Obligation (ARO) and/ or Environmental Cleanup Costs (Environmental Liabilities):

Is there an ARO associated with this project? No.

Are there other environmental cleanup costs associated with this project? No.



Technical Justification

Project Need Statement

This line relocation project is required in accordance with the State of NH Department of Transportation Utility Accommodation Manual and State of NH pole licensing requirements.

Project Objectives

Relocate approximately 6,900 feet of three phase overhead line along Route 106 in Loudon and Canterbury, NH to accommodate a State of NH Department of Transportation road widening project.

Project Scope

Construct in new location approximately 6,900 feet of three phase overhead line in Loudon NH. The new line will relocate the existing conductors onto new poles.

Background / Justification

This work is required in accordance with the State of NH Department of Transportation Utility Accommodation Manual and State of NH pole licensing requirements.

Business Process and / or Technical Improvements

New line will be constructed in a location agreed to by the ROW owner, the NHDOT.

Alternatives Considered with Cost Estimates

No alternatives were considered, as this work is required by state law.

Project Schedule

Milestone/Phase Name	Estimated Date
100% Engineering Completion	10/19/20
Construction Start	10/26/20
In Service Date	12/31/20

Regulatory Approvals

Normal pole licensing requirements will apply for the new line. No other permits or approvals are required.

Risks and Risk Mitigation Plans

None.

Contingency

A contingency of \$10,000 is included to account for the possibility of encountering ledge during pole setting.

References

None.

Attachments (One-Line Diagrams, Images, etc.)

None.

Cost Estimate Backup Details

Project cost is based on STORMS estimate (#3293618) with Outside Services based on an NTX bid from a contractor.



APS 1 - Project Authorization Policy

Appendix 2

Operations Project Authorization Form

Operations Project Authorization Form

Date Prepared: 5/18/2020	Project Title: Pack Monadnock Summit Solution
Company/ies: Eversource NH	Project ID Number: A20W33
Organization: Electric Field Operations	Class(es) of Plant: Distribution Line
Project Initiator: Mark Fraser	Project Category: Reliability -Obsolete Equipment Line
Project Manager: Marc St. Cyr	Project Type: Specific
Project Sponsor: Mark Sandler	Project Purpose: Replace aged and unsafe facilities
Estimated in service date: 11/1/2020	If Transmission Project: N/A
Eng. /Constr. Resources Budgeted? Yes	Capital Investment Part of Original Operating Plan? Yes
Authorization Type: Full Funding	O&M Expenses Part of the Original Operating Plan? Yes
Total Request: \$425,000	

Financial Requirements:

Executive Summary

The Summit Solution is the final piece of the Pack Monadnock Project that was recently approved through the Project Authorization Committee. This project is specifically designed to address the electric power distribution deficiencies at the summit of this New Hampshire State Park.

Three years ago, SegTel, Inc. d/b/a FIRSTLIGHT FIBER, a third-party telecommunication company, requested pole attachments on the utility line running from Highway Route 101 up to the top of Pack Monadnock. This line is approximately 5,200 feet long. The line was originally installed in the 1930's by Greenville Electric Light Company and New England Telephone and Telegraph Company. The initial review of this project showed the need for significant facility upgrades. The project caught the attention of the New Hampshire Public Utilities Commission, the New Hampshire Division of Parks and Recreation, local and State elected officials and members of the public who use the park. In April of 2017, the NH PUC Director of Safety and Security visited the location and cited many safety violations on both the electric and communication facilities.

Because of the sensitive nature of this project and our desire to meet the safety, reliability, aesthetic, and community needs and expectations, a collaborative process was established involving the public, State, and Eversource. Over the last three years, numerous public sessions and site meetings were held. Multiple options were explored for both the summit and ROW lines were reviewed and modified. A solution for the ROW planned was approved earlier this year. In the beginning of May, agreement was reached to address the summit. This request will address the system upgrades to serve the mountain top locations and the removal of the obsolete equipment.



APS 1 - Project Authorization Policy

Appendix 2

Operations Project Authorization Form

Project Costs Summary*Note: Dollar values are in thousands*

	Prior Authorized	2020	2021	2022+	Totals
Capital Additions - Direct	\$ -	\$ 270	\$ -	\$ -	\$ 270
Less Customer Contribution	-	-	-	-	-
Removals net of Salvage %	-	-	-	-	-
Total - Direct Spending	\$ -	\$ 270	\$ -	\$ -	\$ 270
Capital Additions - Indirect	-	154	-	-	154
Subtotal Request	\$ -	\$ 424	\$ -	\$ -	\$ 424
AFUDC	-	1	-	-	1
Total Capital Request	\$ -	\$ 425	\$ -	\$ -	\$ 425
O&M	-	-	-	-	-
Total Request	\$ -	\$ 425	\$ -	\$ -	\$ 425

Financial Evaluation*Note: Dollar values are in thousands*

Direct Capital Costs	Year 1	Year 2	Year 3+	Total
Straight Time Labor	20			20
Overtime Labor	0			0
Outside Services	235			235
Materials	15			15
Other, including contingency amounts (describe)				
Total	270			270

Indirect Capital Costs	Year 1	Year 2	Year 3+	Total
Indirects/Overheads (including benefits)	154			154
Capitalized interest or AFUDC, if any	1			1
Total	155			155

Total Capital Costs	425			425
---------------------	-----	--	--	-----

Less Total Customer Contribution				
----------------------------------	--	--	--	--

Total Capital Project Costs	425			425
------------------------------------	-----	--	--	-----

Total O&M Project Costs				
------------------------------------	--	--	--	--

Note: Explain unique payment provisions, if applicable



APS 1 - Project Authorization Policy

Appendix 2

Operations Project Authorization Form

Future Financial Impacts:

Provide below the estimated future costs that will result from the project:

Note: Dollar values are in thousands:

Future Costs	Year 20__	Year 20__	Year20__	Year 20__+	Total Future Project Costs
Capital	\$ -	\$ -	\$ -	\$ -	\$ -
O&M	-	-	-	-	-
Other	-	-	-	-	-
TOTAL	\$ -	\$ -	\$ -	\$ -	\$ -

Describe the estimated future Capital, O&M and/or Other costs noted above:

What functional area(s) will these future costs be funded in? _____

A representative from the respective functional area is required to be included as a project approver.

If this is other than a Reliability Project, please complete the section below:

Provide below the estimated financial benefits that will result from the project:

Note: Dollar values are in thousands:

Future Benefits	Year 20__	Year 20__	Year20__	Year 20__+	Total Future Project Benefits
Capital	\$ -	\$ -	\$ -	\$ -	\$ -
O&M	-	-	-	-	-
Other	-	-	-	-	-
TOTAL	\$ -	\$ -	\$ -	\$ -	\$ -

Describe the estimated future Capital, O&M and/or Other benefits noted above:

What functional area(s) will these benefits be reflected in? _____

A representative from the respective functional area is required to be included as a project approver.

Asset Retirement Obligation (ARO) and/ or Environmental Cleanup Costs (Environmental Liabilities):

An ARO is a current legal obligation to remove or retire property, plant or equipment at some point in the future. Please refer to APS8 or contact Plant Accounting for further detail.

Is there an ARO associated with this project? No

Are there other environmental cleanup costs associated with this project? No.



APS 1 - Project Authorization Policy

Appendix 2

Operations Project Authorization Form

Technical Justification

Project Need Statement

The existing construction poses a safety risk to the public, accessibility issues for line crews, and has had numerous safety violations cited by the NH PUC Director of Safety and Security (see References section below). The improvements will remove the electrical safety concerns, add capacity and redundancy for the summit customers, and remove most overhead lines from the sightlines of hikers enjoying the scenic vistas.

Project Objectives

The objective of this project is to provide safe and reliable power to the services at the summit of the mountain. All safety issues associated with the existing construction will be addressed and reasonable access will be obtained for maintenance and restoration. It is also important that we work closely with local and State stakeholders to minimize impacts to the State Park and its guests.

Project Scope

The scope of this project is to remove a large portion of the existing distribution system and replace with a mix of new overhead and underground equipment. First, the 50 kVA pole mounted transformer will be replaced with two 50 kVA pad units. These will have the capability of backing each other up should one fail. Underground in conduit will be run from the first pole at the summit across the roadway to the two padmounts. This will allow the removal of the overhead line in the vista viewing area. A new overhead secondary line will be run south behind the tree line to the Crown Castle facility. The new north transformer will intercept the existing feeds to the State Police building, the Fire Tower, and the nearby cell tower. Eversource will work closely with the contractors and the Park personnel to properly restore the site to acceptable conditions.

Background / Justification

The existing electric facilities are in disrepair and pose a potential safety hazard to the public. On April 21, 2017, an inspection by New Hampshire Public Utilities Commission Director of Safety and Security Randy Knepper found multiple safety and code violations on both utility and the customer owned equipment. Eversource was directed to rebuild the line to today's codes and standards, thereby resolving the identified code violations.

Also, communications companies segTEL Inc., and Comcast are requesting attachment to facilities to connect their services to the mountain summit.

Business Process and / or Technical Improvements

All new equipment will be constructed to current utility standards. Redundancy and flexibility are being built into this solution, including having two transformers large enough to handle all summit load along with additional spare conduits to address growth are part of this plan.

Cost Estimate and Assumptions

This project has been fully written in STORMS. Costs have been derived from closely working with Engineering, Operations, Vegetation Management, Surveying, Transmission Construction and Maintenance, Scheduling and Planning, preferred contractors, preferred vendors, and our regulatory group.



APS 1 - Project Authorization Policy

Appendix 2

Operations Project Authorization Form

Alternatives Considered with Cost Estimates

Multiple alternatives have been considered including various overhead and underground options. All were reviewed internally and with external stakeholders. The final solution for this upgraded line was the result of three years of negotiations, public forums, site meetings, constructability reviews, and buy-in from our State partners.

Project Schedule

Milestone/Phase Name	Estimated Completion Date
Design complete	4/30/20
Permits received and construction start	8/15/20
Construction completion	11/1/20

Regulatory Approvals

There were many State permits required by New Hampshire's Department of Natural and Cultural Resources, New Hampshire DOT, New Hampshire PUC, and other State requirements. These are all in progress and expected to be approved.

Risks and Risk Mitigation Plans

The top of the mountain is predominantly ledge. The cost for the civil work included in this PAF reflects the increased cost of pole sets and conduit installation in this environment.

We have been working closely with the various stakeholders for the last three years. We need to continue our strong communication with our State partners and other stakeholders to ensure a positive result and response to this project.

References

Preliminary funding PAF dated 5/9/2017 is attached.

One-Line Diagrams, Attachments, and Images

Included in Preliminary Funding PAF, attached.

REDACTED



APS 1 - Project Authorization Policy

Appendix 2

Operations Project Authorization Form

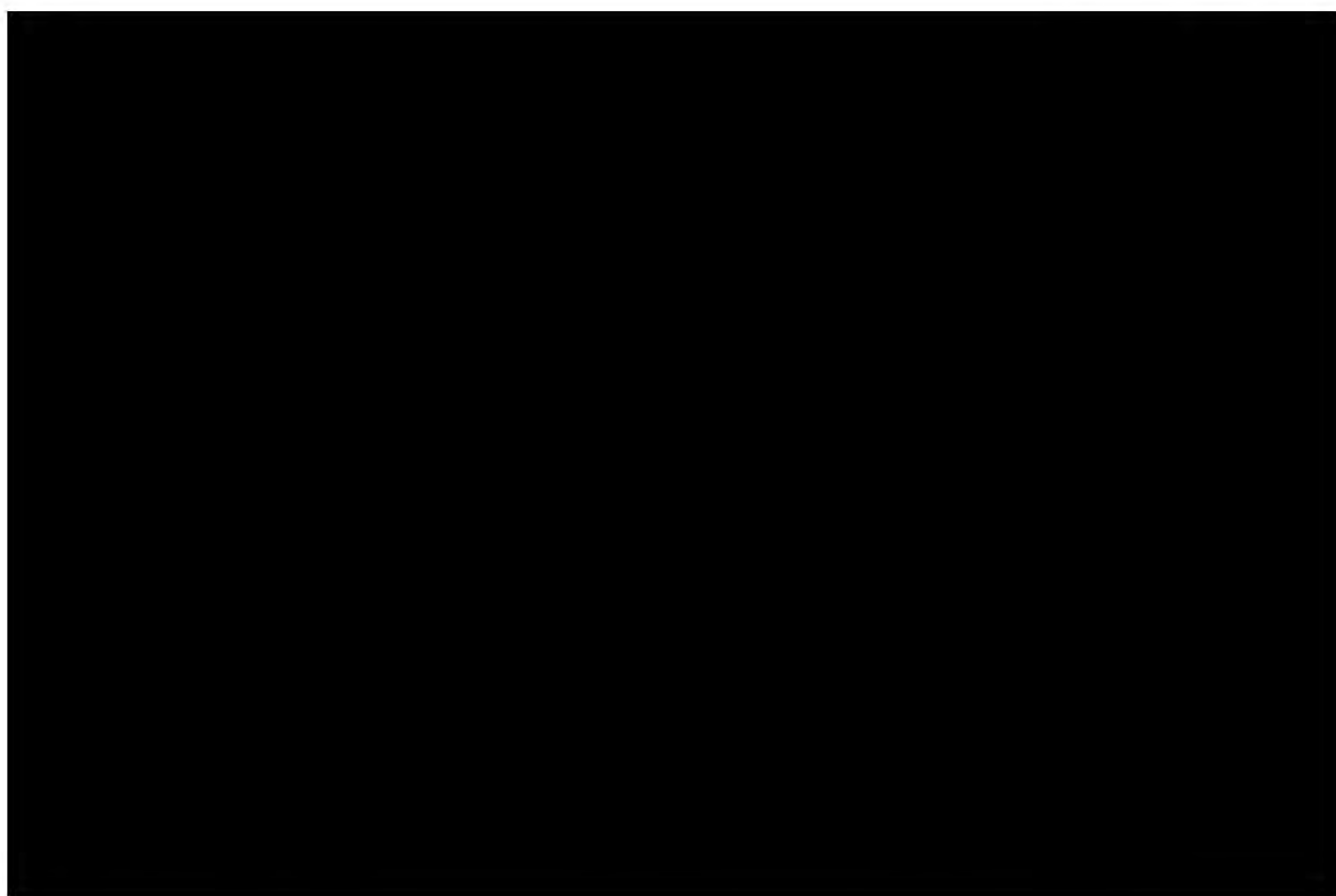



APS 1 - Project Authorization Policy

Appendix 2

Operations Project Authorization Form

Operations Technical Authorization Form

TAF # NH-170037-D

Date Prepared: 5/9/2017	Project Title: Rebuild Single-Phase Line Servicing Pack Monadnock Summit
Company/ies: Eversource NH	Project ID Number: A17C30
Organization: Electric Field Operations	Class(es) of Plant: Distribution Line
Project Initiator: Julie Walsh	Project Category: Reliability - Obsolete Equipment - Line
Project Owner/Manager: Marc Pilotte	Project Type: Specific
Project Sponsor: Jim Eilenberger	Project Purpose: PUC Requirement to replace unsafe line
Estimated in service date: 11/1/17	If Transmission Project: NA
Authorization Type: Detailed Engineering	Authorization Amount: \$22,500

Project Need Statement

This request is for \$22,500 to design this project in the Storms work management system. This figure is based on 10% of the estimated cost of \$225,000.

Single-phase service to several communications towers and other services atop Pack Monadnock was constructed many years ago using above-ground cable in conduit. In places, this conduit is suspended high in the air, due to the uneven terrain of the mountainside. This existing construction poses a safety risk to the public, accessibility issues for line crews, and has had numerous safety violations cited by the NH PUC Director of Safety and Security (see References section below).

Project description

Rebuild second half of line from the end of the existing overhead section to the top of the mountain with single-phase spacer cable along the access road. Remove old above-ground facilities in conduit and vault.

Project Objectives

Comply with PUC request by removing unsafe and obsolete primary line construction and replacing with new overhead construction. Project also facilitates a current Segtel request for third party attachment.

Project Scope

Rebuild approximately 3000 feet of primary line with single phase 1/0 spacer cable. Install 20 new Class 2 poles. Remove approximately 2400 feet of old above-ground cable in conduit, one vault containing a cutout, and several risers. Add one service transformer at the end of primary to split load and shorten secondary runs.

It is anticipated that initial tree clearing to be completed by NH State Parks Department, however, there is no firm commitment as of the date of this document.



APS 1 - Project Authorization Policy

Appendix 2

Operations Project Authorization Form

Background / Justification

Electric facilities are now obsolete as constructed. They are unsightly and a potential safety hazard to the public. An inspection by PUC Director of Safety and Security Randy Knepper on April 21, 2017 found multiple violations on both the utility and the customer equipment, for both electric power and telecommunications. Eversource was requested to propose an overhead solution to address the electric utility violations since the amount of ledge and outcroppings in the terrain prohibit an underground solution. Segtel is requesting attachment to facilities to connect their services to the mountain summit.

Business Process and / or Technical Improvements:

Regulatory Requirement, System renewal.

Cost Estimate and Assumptions

\$225,000 –This cost estimate assumes 18 overhead spans at \$10,000 per pole span (\$7000 for pole, wire, and other hardware, plus \$3000 extra to cover tree removals and ledge pole sets). An additional \$45,000 is included for removals.

Alternatives Considered with Cost Estimates

Replace above-ground conduit with direct-buried cable in conduit. Due to the rugged mountain terrain, this was not considered a viable option. Randy Knepper, PUC Director of Safety & Security, proposes an overhead solution as the current terrain prohibits an underground solution.

Project Schedule

Describe the project schedule and milestones. Include estimated start and end dates.

Milestone/Phase Name	Estimated Completion Date
Tree clearing	8/1/17
Poles set	9/1/17
Line work complete	11/1/17

Regulatory Approvals

None

Risks and Risk Mitigation Plans

The State (DRED) is indicating a willingness to pay for the initial tree removals. However, there is no obligation for them to do so yet, and therefore removals have been included in the cost estimate.



APS 1 - Project Authorization Policy

Appendix 2

Operations Project Authorization Form

References

Email from PUC Director of Safety and Security from 4/24/17:

From: "Knepper, Randy" <Randy.Knepper@puc.nh.gov>
 To: "Spoerl, Robert" <Robert.Spoerl@dred.nh.gov>, Ronald L. Pepin/NUS@NU,
 Cc: James C. Eilenberger/NUS@NU, Marc W. Pilotte/NUS@NU, Karen T. Mackey/NUS@NU,
 PSNHPUCLiaison@NU, "Linnenbringer, Frank" <Frank.Linnenbringer@dot.nh.gov>, "Lyons,
 Johanna" <Johanna.Lyons@dred.nh.gov>
 Date: 04/24/2017 10:28 AM
 Subject: RE: Pack Monadnock utility relocation

Yes, my inspection on April 21, 2017 found numerous safety violations both on the customer side and utility. This includes electric power and telecommunications. I am less concerned on how and why but more concerned on reinstalling the utilities and private service connections in a manner that is safe, legal, documented, properly placed, well coordinated and can last into the future. The present situation was created over time in a haphazard manner but can be rectified. This will involve coordination between the end users, multiple state agencies, private land owners, power and telecommunications providers and requires a collaborative approach. The PUC can act as a co-facilitator. I envision multiple meetings to get things moving. At this point I have informed our general counsel and she will be reaching out to AG's office to help coordinate. Here are my initial thoughts:

- 1) Legal Research – which statutes and rules apply including licensing
- 2) Land and Parcel Research – build a historical record of each segment
- 3) Survey/ GPS/ GEOcoding –any existing portion that will be reused, new proposals, and new installation
- 4) Define current and future needs of end users
- 5) Design and Layout – Eversource needs to propose an **overhead solution** – the amount of ledge and outcroppings prohibit an underground solution
- 6) Coordination with attachees
- 7) Cost considerations and scheduling considerations
- 8) View, Park needs, end user needs and ROW considerations

My suggestion is for Eversource to propose a preliminary solution with any potential options to get us rolling.

Randy Knepper
 Director of Safety and Security
 New Hampshire Public Utilities Commission
 21 South Fruit St
 Concord NH 03301
 603-271-6026

One-Line Diagrams, Attachments, and Images



APS 1 - Project Authorization Policy

Appendix 2

Operations Project Authorization Form

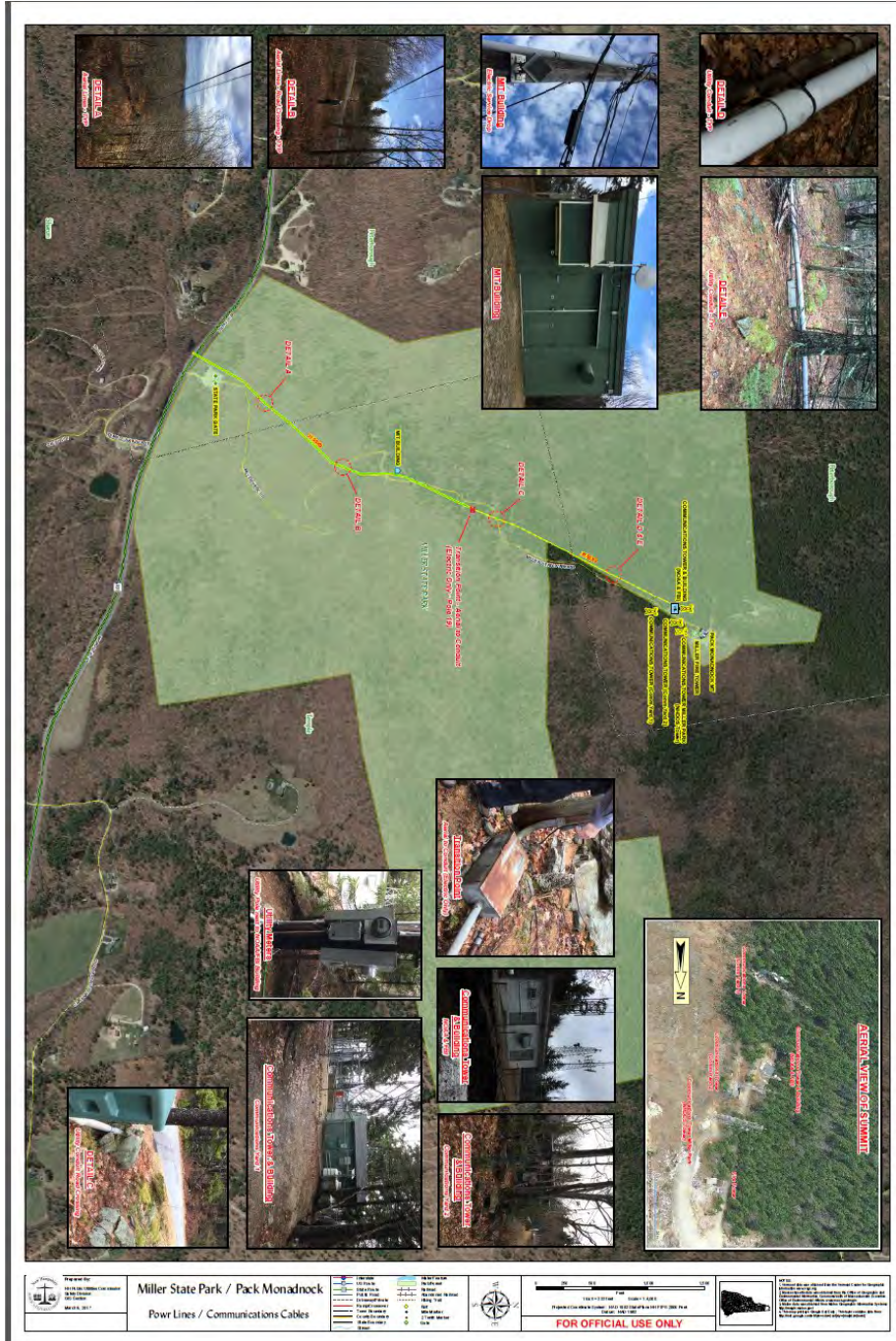



APS 1 - Project Authorization Policy

Appendix 2

Operations Project Authorization Form





APS 1 - Project Authorization Policy

Appendix 2

Operations Project Authorization Form





APS 1 - Project Authorization Policy

Appendix 2

Operations Project Authorization Form





Operations Project Authorization Form

Date Prepared: 01/12/2021	Project Title: Reconductor Academy Rd
Company: Eversource NH	Project Number: A21C05
Organization: Distribution Engineering	Class(es) of Plant: D Line
Project Initiator: Bob Krewson	Project Category: Lines - Conductor
Project Manager: Marc Pilotte	Project Type: Specific
Project Sponsor: Russel Johnson	Project Purpose: Improve Reliability
Estimated in service date: 08/01/2021	Capital Investment part of original Oper. Plan: Yes
Eng./Constr. Resources Budgeted? Yes	O&M Expenses part of original Oper. Plan: Yes
Authorization Type: Full Funding	Facility Type (check all that apply):
Total Request: \$895,000	<input type="checkbox"/> PTF <input type="checkbox"/> non-PTF <input checked="" type="checkbox"/> Distribution

Financial Requirements:

Executive Summary

This PAF request \$895,000 to reconductor portions of open wire along Academy Road in Pembroke with spacer cable.

The Academy Rd section of the 34W18 circuit in Pembroke has experienced numerous tree related outages in the past. Though this stretch of circuit has been trimmed to ETT specifications, there were a number of abutters who would not agree to this level of trimming. This project proposes to reconductor two sections of Academy Rd (3,650 feet rather than the entire length) based on a review of past outages and in consultation with Vegetation Management. Work also includes removal of four large pines outside the reconducted area.

Cost per customer minute saved is \$6.65.



Project Costs Summary *Note: Dollar values are in thousands*

Line item Category	Prior Authorized	Actuals to Date	2020 to Go	2021	2022	2023	2024	2025	Total
1. ROW / Easements / Land Acquisition	\$0	\$0	\$0	\$0	\$0	\$0	\$0	\$0	\$0
2. Environmental Approvals / Permits	\$0	\$0	\$0	\$0	\$0	\$0	\$0	\$0	\$0
3. Outreach	\$0	\$0	\$0	\$0	\$0	\$0	\$0	\$0	\$0
4. Siting Approvals / Permits	\$0	\$0	\$0	\$0	\$0	\$0	\$0	\$0	\$0
5. Engineering / Design	\$0	\$0	\$0	\$0	\$0	\$0	\$0	\$0	\$0
6. Materials (Eversource purchased)	\$0	\$0	\$0	\$160	\$0	\$0	\$0	\$0	\$160
7. Construction (incl mat'l's by contractors)	\$0	\$0	\$0	\$270	\$0	\$0	\$0	\$0	\$270
8. Testing / Commissioning	\$0	\$0	\$0	\$0	\$0	\$0	\$0	\$0	\$0
9. Project Mgmt Team	\$0	\$0	\$0	\$0	\$0	\$0	\$0	\$0	\$0
10. Removals	\$0	\$0	\$0	\$20	\$0	\$0	\$0	\$0	\$20
11. Other	\$0	\$0	\$0	\$0	\$0	\$0	\$0	\$0	\$0
12. Risks	\$0	\$0	\$0	\$0	\$0	\$0	\$0	\$0	\$0
SUBTOTAL DIRECTS W/ RISKS	\$0	\$0	\$0	\$450	\$0	\$0	\$0	\$0	\$450
13. Indirects/Overhead	\$0	\$0	\$0	\$426	\$0	\$0	\$0	\$0	\$426
14. AFUDC	\$0	\$0	\$0	\$19	\$0	\$0	\$0	\$0	\$19
PROJECT TOTAL – BASELINE BUDGET	\$0	\$0	\$0	\$895	\$0	\$0	\$0	\$0	\$895
15. Contingency	\$0	\$0	\$0	\$0	\$0	\$0	\$0	\$0	\$0
TOTAL CAPITAL REQUEST	\$0	\$0	\$0	\$895	\$0	\$0	\$0	\$0	\$895
16. Reimbursables/Customer Contribution	\$0	\$0	\$0	\$0	\$0	\$0	\$0	\$0	\$0
PROJECT TOTAL (LESS REIMBURSABLES)	\$0	\$0	\$0	\$895	\$0	\$0	\$0	\$0	\$895
O&M	\$0	\$0	\$0	\$0	\$0	\$0	\$0	\$0	\$0
TOTAL REQUEST	\$0	\$0	\$0	\$895	\$0	\$0	\$0	\$0	\$895

Note: Explain unique payment provisions, if applicable: *Provide a detailed breakdown of Other costs here.*



Breakout Costs

Note: Dollar values are in thousands

Line item Category	Prior Authorized	Actuals to Date	2020 to Go	2021	2022	2023	2024	2025	Total
ST Labor	\$0	\$0	\$0	\$220	\$0	\$0	\$0	\$0	\$220
OT Labor	\$0	\$0	\$0	\$0	\$0	\$0	\$0	\$0	\$0
Outside Services Labor	\$0	\$0	\$0	\$50	\$0	\$0	\$0	\$0	\$50
Materials*	\$0	\$0	\$0	\$160	\$0	\$0	\$0	\$0	\$160
Removals	\$0	\$0	\$0	\$20	\$0	\$0	\$0	\$0	\$20
Other	\$0	\$0	\$0	\$0	\$0	\$0	\$0	\$0	\$0
Indirects	\$0	\$0	\$0	\$426	\$0	\$0	\$0	\$0	\$426
AFUDC	\$0	\$0	\$0	\$19	\$0	\$0	\$0	\$0	\$19
TOTAL CAPITAL REQUEST - W/O REIMBURSABLES	\$0	\$0	\$0	\$895	\$0	\$0	\$0	\$0	\$895

*All materials including Eversource purchased and outside service purchased. Note that outside service purchased material included in construction in project cost summary above.

Trimming costs included in Outside Services are estimated by Veg Management at approximately \$15,000.



Future Financial Impacts:

Provide below the estimated future costs that will result from the project:

Note: Dollar values are in thousands

Future Costs	Year 20__	Year 20__	Year 20__	Year 20__ +	Total Future Project Costs
Capital	\$ -	\$ -	\$ -	\$ -	\$ -
O&M	-	-	-	-	-
Other	-	-	-	-	-
TOTAL	\$ -	\$ -	\$ -	\$ -	\$ -

Describe the estimated future Capital, O&M, and/or Other costs noted above:

What functional area(s) will these future costs be funded in? _____
A representative from the respective functional area is required to be included as a project approver.

Provide below the estimated future financial benefits that will result from the project:

Note: Dollar values are in thousands

Future Benefits	Year 20__	Year 20__	Year 20__	Year 20__ +	Total Future Project Benefits
Capital	\$ -	\$ -	\$ -	\$ -	\$ -
O&M	-	-	-	-	-
Other	-	-	-	-	-
TOTAL	\$ -	\$ -	\$ -	\$ -	\$ -

Describe the estimated future Capital, O&M, and/or Other benefits noted above:

What functional area(s) will these benefits be reflected in? _____
A representative from the respective functional area is required to be included as a project approver.

Asset Retirement Obligation (ARO) and/ or Environmental Cleanup Costs (Environmental Liabilities):

Is there an ARO associated with this project? N/A

Are there other environmental cleanup costs associated with this project? N/A



Technical Justification

Project Need Statement

The Academy Road portion of the 34W18 circuit has been particularly prone to tree related interruptions. Replacement of the #2 ACSR with 1/0, 34 kv spacer cable will harden this stretch of circuit to better resist such outages.

Project Objectives

Install spacer cable in two areas along Academy Road so that tree related outages due to contact with bare wire will be greatly reduced in those areas.

Project Scope

Install new pole plant and associated equipment including 3-1/0 spacer cable in place of 3- #2 ACSR conductors on approximately 3,650 feet of 15 kV, three phase line along Academy Road in Pembroke. In anticipation of future load driven conversion work, 34 kV spacer will be installed.

Background / Justification

There is an average of just under one tree related outage per year on Academy Road. When this happens, up to 1,130 customers on Academy Rd and beyond can be affected (there are no circuit ties). Spacer cable hardens the circuit, better enabling resistance to tree and animal contacts.

Business Process and / or Technical Improvements

- Installation of spacer cable increases the ability of the circuit to resist vegetation and animal related events.
- The compact configuration of spacer cable reduces the window of vegetation exposure as compared to open wire construction. This is particularly important in areas where ES has been denied ETT trimming approval by abutters.
- An additional benefit is the increase in circuit capacity by 20%.
- The Academy Road parallel 500 kva steps on all phases are getting close to 100% loading (A/B/C ϕ = 81/91/92% respectively). Reconductoring with 34 kV spacer cable will be a first step toward the eventuality of circuit conversion.

Alternatives Considered with Cost Estimates

This project was originally submitted to reconnector Academy Rd in its entirety. The \$1,813,000 estimate to do this was considered cost prohibitive. Instead, the project was revised to selectively reconnector portions of Academy Rd. based on an analysis of past outages and in consultation with Vegetation Management. In so doing, the cost per customer minute saved improved from \$13.48 to \$6.65.

Project Schedule

Milestone/Phase Name	Estimated Date
100% Engineering Completion	Done
Construction Start	May 1, 2021
In Service Date	August 1, 2021

Regulatory Approvals

Permission for any new pole locations will be required from the Town of Pembroke.

REDACTED

EVERSOURCE
Project Authorization Form

Risks and Risk Mitigation Plans

Pembroke is a Consolidated Communications set area, and a number of pole upgrades will be necessary. If CCI declines to set poles and this increases the cost, additional funding will be sought.

Contingency

None.

References

None.

Attachments (One-Line Diagrams, Images, etc.)

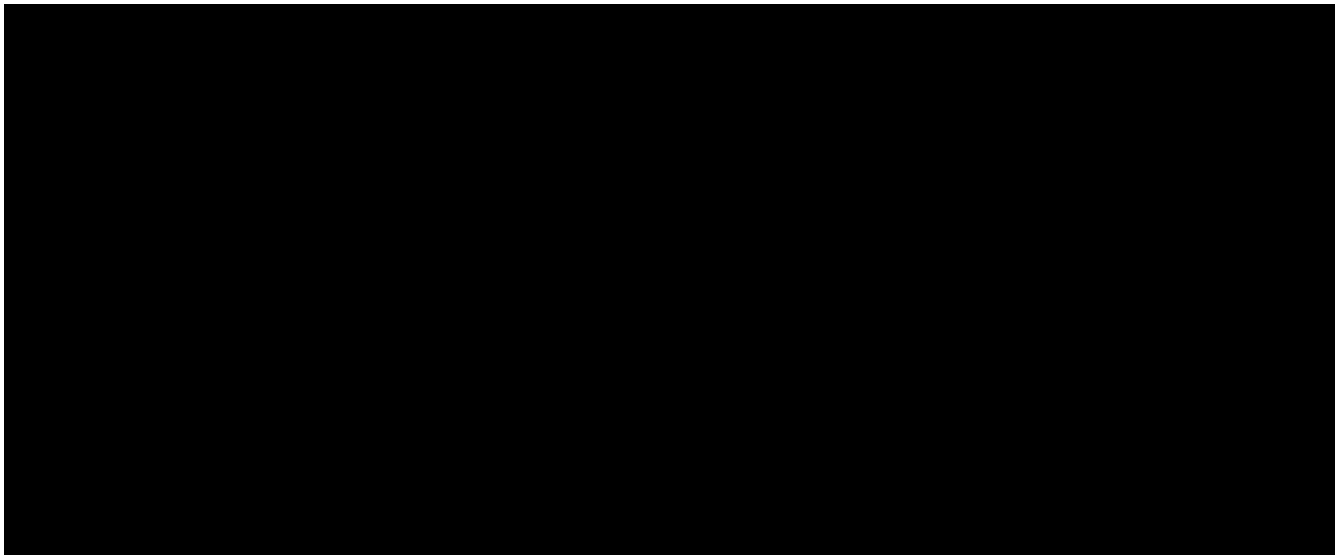

Cost Estimate Backup Details

Cost estimate based on \$160 per foot.



Operations Project Authorization Form

Date Prepared: 12/29/2020	Project Title: Meetinghouse Rd S/S Off-load
Company: Eversource NH	Project Number: A21C19
Organization: Distribution Engineering	Class(es) of Plant: D SS
Project Initiator: Michael Warren	Project Category: Stations - Transformers
Project Manager: Marc Pilotte	Project Type: Specific
Project Sponsor: Russel Johnson	Project Purpose: Off-load Overloaded S/S Transformer (TB32)
Estimated in service date: 06/01/2021	Capital Investment part of original Oper. Plan: Yes
Eng./Constr. Resources Budgeted? Yes	O&M Expenses part of original Oper. Plan: Yes
Authorization Type: Full Funding	Facility Type (check all that apply):
Total Request: \$747,000	<input type="checkbox"/> PTF <input type="checkbox"/> non-PTF <input type="checkbox"/> Distribution

Financial Requirements:

Executive Summary

This PAF requests \$747,000 to offload the Meetinghouse Road transformer and reduce load on a set of parallel step transformers.

The Meetinghouse Road substation transformer TB32 in Bedford reached 108% of nameplate in 2020. This project will offload the transformer by reconductoring and converting a section of Joppa Hill Road with three phase covered wire then moving a portion of North Amherst Road off the 3W2 to the 322X12. This work will also reduce loading on parallel 500 KVA step-down transformers on the 322X12 which reached 97% of nameplate in summer 2020. Total cost of the project is \$747,000 based on engineering estimate.



Project Costs Summary *Note: Dollar values are in thousands*

Line item Category	Prior Authorized	Actuals to Date	2020 to Go	2021	2022	2023	2024	2025	Total
1. ROW/ Easements / Land Acquisition	\$0	\$0	\$0	\$0	\$0	\$0	\$0	\$0	\$0
2. Environmental Approvals / Permits	\$0	\$0	\$0	\$0	\$0	\$0	\$0	\$0	\$0
3. Outreach	\$0	\$0	\$0	\$0	\$0	\$0	\$0	\$0	\$0
4. Siting Approvals / Permits	\$0	\$0	\$0	\$0	\$0	\$0	\$0	\$0	\$0
5. Engineering / Design	\$0	\$0	\$0	\$171	\$0	\$0	\$0	\$0	\$171
6. Materials (Eversource purchased)	\$0	\$0	\$0	\$115	\$0	\$0	\$0	\$0	\$115
7. Construction (incl mat'l's by contractors)	\$0	\$0	\$0	\$67	\$0	\$0	\$0	\$0	\$67
8. Testing / Commissioning	\$0	\$0	\$0	\$0	\$0	\$0	\$0	\$0	\$0
9. Project Mgmt Team	\$0	\$0	\$0	\$0	\$0	\$0	\$0	\$0	\$0
10. Removals	\$0	\$0	\$0	\$0	\$0	\$0	\$0	\$0	\$0
11. Other	\$0	\$0	\$0	\$0	\$0	\$0	\$0	\$0	\$0
12. Risks	\$0	\$0	\$0	\$0	\$0	\$0	\$0	\$0	\$0
SUBTOTAL DIRECTS W/ RISKS	\$0	\$0	\$0	\$353	\$0	\$0	\$0	\$0	\$353
13. Indirects/Overhead	\$0	\$0	\$0	\$377	\$0	\$0	\$0	\$0	\$377
14. AFUDC	\$0	\$0	\$0	\$17	\$0	\$0	\$0	\$0	\$17
PROJECT TOTAL – BASELINE BUDGET	\$0	\$0	\$0	\$747	\$0	\$0	\$0	\$0	\$747
15. Contingency	\$0	\$0	\$0	\$0	\$0	\$0	\$0	\$0	\$0
TOTAL CAPITAL REQUEST	\$0	\$0	\$0	\$747	\$0	\$0	\$0	\$0	\$747
16. Reimbursables/Customer Contribution	\$0	\$0	\$0	\$0	\$0	\$0	\$0	\$0	\$0
PROJECT TOTAL (LESS REIMBURSABLES)	\$0	\$0	\$0	\$747	\$0	\$0	\$0	\$0	\$747
O&M	\$0	\$0	\$0	\$0	\$0	\$0	\$0	\$0	\$0
TOTAL REQUEST	\$0	\$0	\$0	\$747	\$0	\$0	\$0	\$0	\$747

Note: Explain unique payment provisions, if applicable: *Provide a detailed breakdown of Other costs here.*



Breakout Costs

Note: Dollar values are in thousands

Line item Category	Prior Authorized	Actuals to Date	2020 to Go	2021	2022	2023	2024	2025	Total
ST Labor	\$0	\$0	\$0	\$171	\$0	\$0	\$0	\$0	\$171
OT Labor	\$0	\$0	\$0	\$0	\$0	\$0	\$0	\$0	\$0
Outside Services Labor	\$0	\$0	\$0	\$67	\$0	\$0	\$0	\$0	\$67
Materials*	\$0	\$0	\$0	\$115	\$0	\$0	\$0	\$0	\$115
Removals	\$0	\$0	\$0	\$0	\$0	\$0	\$0	\$0	\$0
Other	\$0	\$0	\$0	\$0	\$0	\$0	\$0	\$0	\$0
Indirects	\$0	\$0	\$0	\$377	\$0	\$0	\$0	\$0	\$377
AFUDC	\$0	\$0	\$0	\$17	\$0	\$0	\$0	\$0	\$17
TOTAL CAPITAL REQUEST - W/O REIMBURSABLES	\$0	\$0	\$0	\$747	\$0	\$0	\$0	\$0	\$747

*All materials including Eversource purchased and outside service purchased. Note that outside service purchased material included in construction in project cost summary above.



Future Financial Impacts:

Provide below the estimated future costs that will result from the project:

Note: Dollar values are in thousands

Future Costs	Year 20__	Year 20__	Year 20__	Year 20__ +	Total Future Project Costs
Capital	\$ -	\$ -	\$ -	\$ -	\$ -
O&M	-	-	-	-	-
Other	-	-	-	-	-
TOTAL	\$ -	\$ -	\$ -	\$ -	\$ -

Describe the estimated future Capital, O&M, and/or Other costs noted above:

What functional area(s) will these future costs be funded in? _____

A representative from the respective functional area is required to be included as a project approver.

Provide below the estimated future financial benefits that will result from the project:

Note: Dollar values are in thousands

Future Benefits	Year 20__	Year 20__	Year 20__	Year 20__ +	Total Future Project Benefits
Capital	\$ -	\$ -	\$ -	\$ -	\$ -
O&M	-	-	-	-	-
Other	-	-	-	-	-
TOTAL	\$ -	\$ -	\$ -	\$ -	\$ -

Describe the estimated future Capital, O&M, and/or Other benefits noted above:

What functional area(s) will these benefits be reflected in? _____

A representative from the respective functional area is required to be included as a project approver.

Asset Retirement Obligation (ARO) and/ or Environmental Cleanup Costs (Environmental Liabilities):

Is there an ARO associated with this project? No.

Are there other environmental cleanup costs associated with this project? No.



Technical Justification

Project Need Statement

On August 11th, 2020, Aclara Line Sensors showed loading on TB32 at Meetinghouse Road substation to be 232 amps, 238 amps and 278 amps on phases A, B, and C respectively. This equates to 5,385 kVA on a 5,000 kVA transformer or 108% of nameplate value. System Planning shows expected load growth in the area to be 0.5% for 2021.

Project Objectives

Off-load the 5 MVA, 35 kV to 12 kV substation transformer at Meetinghouse Road substation in Bedford NH. Completing this project will remove approximately 80 amps of load leaving projected load levels on phases A, B, and C of 208 amps, 184 amps, and 278 amps. The project will also address a set of parallel 500 kVA steps that reached 97% of nameplate on Joppa Hill Road (322X12 circuit). Load balancing would then be completed to lower loading on phase C.

Project Scope

Reconductor approximately 3,319 feet of single phase 1/0 and neutral with three phase 1/0 covered wire along Joppa Hill Road. Utilize approximately 2,550 feet of existing phase of 1/0 ACSR currently not in use from Carriage Lane up to North Amherst Road. Convert ten overhead single-phase transformers from 7,200 volts to 19,900 volts. Install six new overhead 19.9 to 7.2 kV step transformers for street side taps and North Amherst load. Remove two existing 19.9kv to 7.2 kV step transformers on Joppa Hill Road. Install cutouts for new open point between 3W2 and 322X12 on North Amherst Road. Install new three phase DA device at start of Joppa Hill Road.

Background / Justification

1969 vintage transformer TB32 at Meetinghouse Road substation which feeds over 1,260 customers has been loaded above nameplate for the past two years. This past summer (2020) the unit saw peak loads putting it at 108% of nameplate value. This project not only lowers expected peak loading to 96% of nameplate rating but also helps address a set of parallel 500 KVA step transformers on the 322X12 which reached 97% of nameplate in summer 2020.

Business Process and / or Technical Improvements

Reduced loading on the Meetinghouse substation transformer to below nameplate.

Alternatives Considered with Cost Estimates

- 1) Shift approximately 785 KVA connected from the 3W2 to the 322X12 circuit via Bedford Center Road. Engineering estimate is \$52K. Only lowers TB32 to 99% of nameplate and does not address 322X12 step transformer on Joppa Hill which is at 97% of nameplate.
- 2) Run three-phase all the way up Joppa Hill to North Amherst, 3,319 feet plus 2,500 feet for a total distance of 5,819 feet. This solution allows for additional load to be transferred from the tail end of the 3W2 circuit to the 322X12 further reducing the TB32 loading at Meetinghouse Road substation to well below 96% of nameplate. Engineering estimate of \$1,000,000.

EVERSOURCE

Project Authorization Form

Project Schedule

Milestone/Phase Name	Estimated Date
100% Engineering Completion	12/15/2020
Construction Start	04/01/2021
Testing/Commissioning	05/15/2021
In Service Date	06/01/2021

Regulatory Approvals

None

Risks and Risk Mitigation Plans

Cost could escalate due to bids or inaccurate estimate assumptions. If the project is bid and the bids are higher than anticipated, additional funding will have to be sought.

Bedford is CCI's pole maintenance area which could impact scheduling or project costs if CCI declines to set poles. Operations will need to work closely with CCI to ensure the project is completed in a timely manner. If costs increase due to pole setting, supplemental funding will be sought.

Tree trimming is an unknown cost at this time. When the project is sent out to bid and the pole set question has been answered the associated trimming costs could increase the project cost.

Contingency

None

References

No.

Cost Estimate Backup Details

Original Engineering estimate utilized the following assumptions:

\$160 per ft for three-phase covered wire reconductor and conversion.
\$10K/8K per site for new parallel/single step transformer installations.
\$1300 per location for single-phase conversion not requiring new pole.
Did not factor in new three phase DA cost.

Work written in Maximo, but currently the estimating function is not working.

REDACTED



Attachments (One-Line Diagrams, Images, etc.)

Figure 1. Circuit Overview

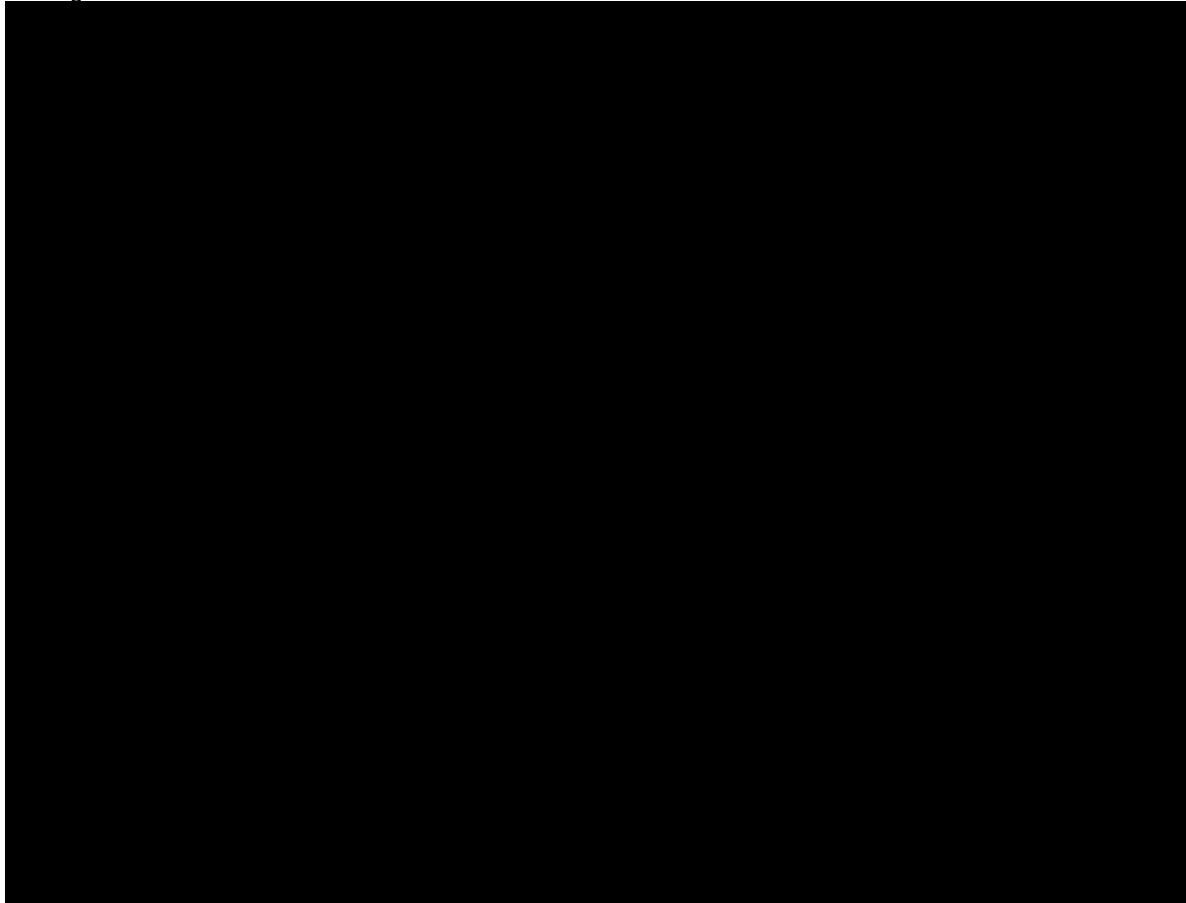

REDACTED



Figure 2. Joppa Rd section

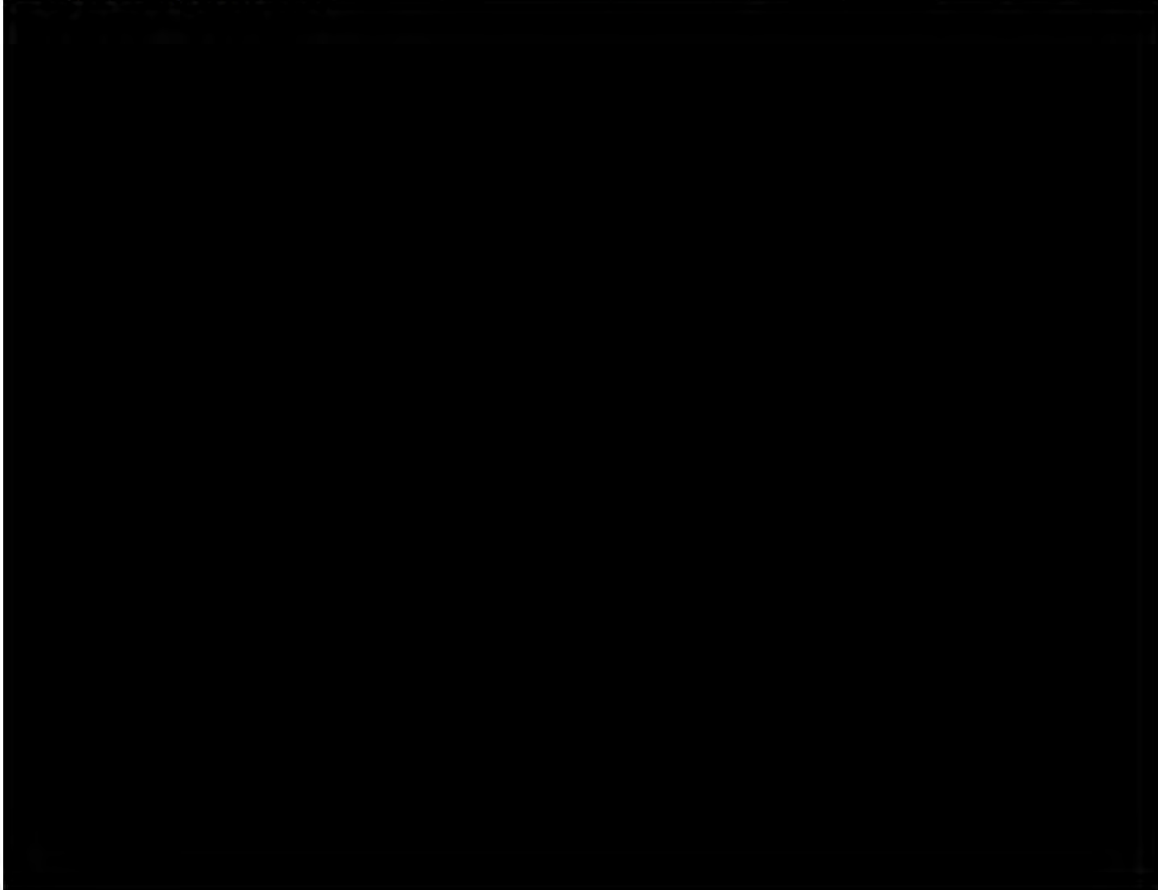



Operations Project Authorization Form

Date Prepared: 12/31/2020	Project Title: 322X14 Circuit Off-load
Company: Eversource NH	Project Number: A21C20
Organization: Distribution Engineering	Class(es) of Plant: D Line
Project Initiator: Michael Warren	Project Category: Lines - Conductor
Project Manager: Marc Pilotte	Project Type: Specific
Project Sponsor: Russel Johnson	Project Purpose: Off-load Overloaded Step and Primary
Estimated in service date: 06/01/2021	Capital Investment part of original Oper. Plan: Yes
Eng./Constr. Resources Budgeted? Yes	O&M Expenses part of original Oper. Plan: Yes
Authorization Type: Full Funding	Facility Type (check all that apply):
Total Request: \$141,000	<input type="checkbox"/> PTF <input type="checkbox"/> non-PTF <input checked="" type="checkbox"/> Distribution

Financial Requirements:

Executive Summary

The PAF requests \$141,000 to offload the 322X14 circuit in Goffstown.

This project shifts load off the 322X14 circuit by filling in a 400-foot gap to the 18W1 circuit on College Road in Goffstown with 1/0 covered conductor and converting twelve overhead transformers. Loading on the circuit's primary feeder reached 118% of normal summer rating and the 500 KVA step feeding the circuit exceeded nameplate reaching 108% for summer 2020. In addition, this solution looks to improve voltage at the tail end of the 322X14. Total estimated cost of the project is \$141,000.



Project Costs Summary *Note: Dollar values are in thousands*

Line item Category	Prior Authorized	Actuals to Date	2020 to Go	2021	2022	2023	2024	2025	Total
1. ROW/ Easements / Land Acquisition	\$0	\$0	\$0	\$0	\$0	\$0	\$0	\$0	\$0
2. Environmental Approvals / Permits	\$0	\$0	\$0	\$0	\$0	\$0	\$0	\$0	\$0
3. Outreach	\$0	\$0	\$0	\$0	\$0	\$0	\$0	\$0	\$0
4. Siting Approvals / Permits	\$0	\$0	\$0	\$0	\$0	\$0	\$0	\$0	\$0
5. Engineering / Design	\$0	\$0	\$0	\$30	\$0	\$0	\$0	\$0	\$30
6. Materials (Eversource purchased)	\$0	\$0	\$0	\$24	\$0	\$0	\$0	\$0	\$24
7. Construction (incl mat'l's by contractors)	\$0	\$0	\$0	\$15	\$0	\$0	\$0	\$0	\$15
8. Testing / Commissioning	\$0	\$0	\$0	\$0	\$0	\$0	\$0	\$0	\$0
9. Project Mgmt Team	\$0	\$0	\$0	\$0	\$0	\$0	\$0	\$0	\$0
10. Removals	\$0	\$0	\$0	\$1	\$0	\$0	\$0	\$0	\$1
11. Other	\$0	\$0	\$0	\$0	\$0	\$0	\$0	\$0	\$0
12. Risks	\$0	\$0	\$0	\$0	\$0	\$0	\$0	\$0	\$0
SUBTOTAL DIRECTS W/ RISKS	\$0	\$0	\$0	\$70	\$0	\$0	\$0	\$0	\$70
13. Indirects/Overhead	\$0	\$0	\$0	\$71	\$0	\$0	\$0	\$0	\$71
14. AFUDC	\$0	\$0	\$0	\$0	\$0	\$0	\$0	\$0	\$0
PROJECT TOTAL - BASELINE BUDGET	\$0	\$0	\$0	\$141	\$0	\$0	\$0	\$0	\$141
15. Contingency	\$0	\$0	\$0	\$0	\$0	\$0	\$0	\$0	\$0
TOTAL CAPITAL REQUEST	\$0	\$0	\$0	\$141	\$0	\$0	\$0	\$0	\$141
16. Reimbursables/Customer Contribution	\$0	\$0	\$0	\$0	\$0	\$0	\$0	\$0	\$0
PROJECT TOTAL (LESS REIMBURSABLES)	\$0	\$0	\$0	\$141	\$0	\$0	\$0	\$0	\$141
O&M	\$0	\$0	\$0	\$0	\$0	\$0	\$0	\$0	\$0
TOTAL REQUEST	\$0	\$0	\$0	\$141	\$0	\$0	\$0	\$0	\$141

Note: Explain unique payment provisions, if applicable: *Provide a detailed breakdown of Other costs here.*



Breakout Costs

Note: Dollar values are in thousands

Line item Category	Prior Authorized	Actuals to Date	2020 to Go	2021	2022	2023	2024	2025	Total
ST Labor	\$0	\$0	\$0	\$30	\$0	\$0	\$0	\$0	\$30
OT Labor	\$0	\$0	\$0	\$0	\$0	\$0	\$0	\$0	\$0
Outside Services Labor	\$0	\$0	\$0	\$15	\$0	\$0	\$0	\$0	\$15
Materials*	\$0	\$0	\$0	\$24	\$0	\$0	\$0	\$0	\$24
Removals	\$0	\$0	\$0	\$1	\$0	\$0	\$0	\$0	\$1
Other	\$0	\$0	\$0	\$0	\$0	\$0	\$0	\$0	\$0
Indirects	\$0	\$0	\$0	\$71	\$0	\$0	\$0	\$0	\$71
AFUDC	\$0	\$0	\$0	\$0	\$0	\$0	\$0	\$0	\$0
TOTAL CAPITAL REQUEST - W/O REIMBURSABLES	\$0	\$0	\$0	\$141	\$0	\$0	\$0	\$0	\$141

*All materials including Eversource purchased and outside service purchased. Note that outside service purchased material included in construction in project cost summary above.



Future Financial Impacts:

Provide below the estimated future costs that will result from the project:

Note: Dollar values are in thousands

Future Costs	Year 20__	Year 20__	Year 20__	Year 20__ +	Total Future Project Costs
Capital	\$ -	\$ -	\$ -	\$ -	\$ -
O&M	-	-	-	-	-
Other	-	-	-	-	-
TOTAL	\$ -	\$ -	\$ -	\$ -	\$ -

Describe the estimated future Capital, O&M, and/or Other costs noted above:

What functional area(s) will these future costs be funded in? _____
A representative from the respective functional area is required to be included as a project approver.

Provide below the estimated future financial benefits that will result from the project:

Note: Dollar values are in thousands

Future Benefits	Year 20__	Year 20__	Year 20__	Year 20__ +	Total Future Project Benefits
Capital	\$ -	\$ -	\$ -	\$ -	\$ -
O&M	-	-	-	-	-
Other	-	-	-	-	-
TOTAL	\$ -	\$ -	\$ -	\$ -	\$ -

Describe the estimated future Capital, O&M, and/or Other benefits noted above:

What functional area(s) will these benefits be reflected in? _____
A representative from the respective functional area is required to be included as a project approver.

Asset Retirement Obligation (ARO) and/ or Environmental Cleanup Costs (Environmental Liabilities):

Is there an ARO associated with this project? No

Are there other environmental cleanup costs associated with this project? No



Technical Justification

Project Need Statement

Aclara Line Sensor data installed at the beginning of this circuit showed peak loading on July 19, 2020, of 225 amps at 2.4 kV. Loading on the #2 ACSR primary feeder conductor reached 118% of its normal summer rating of 190 amps and the 500 KVA step-down transformer feeding the circuit exceeded nameplate reaching 108%.

Project Objectives

Off-load the overloaded primary feeder and step-down transformer on College Road in Goffstown. Convert a section of the circuit and shift load to the 18W1 circuit by filling in a 400-foot gap along College Road with 1/0 covered conductor. Improve voltage at the tail end of the 322X14 which is projected to be as low as 114.9 volts (on a 120 volt base) as identified from circuit modeling. This solution is expected to reduce loading on the primary feeder to 75% of its normal summer rating of 190 amps and 68% of step-down transformer nameplate rating.

Project Scope

Install approximately 400 feet of new 1/0 covered conductor along College Road (pole 52/17) to St Anselm's Drive (pole 86/25). Convert twelve overhead 2.4 kV transformers to 7.2 kV transformers and move them from the 322X14 to the 18W1 via College Road. Install load side fusing protection for the 500 KVA step-down transformer which currently does not exist.

Background / Justification

Loading on #2 ACSR primary feeder, located on the 322X14 circuit on College Road, Goffstown, peaked at 225 amps or 118% of its summer normal rating of 190 amps on July 19, 2020. In addition, the 500 kVA step-down transformer peaked at 540 kVA or 108% of nameplate. Primary voltage at the tail end of the 322X14 which is projected to be as low as 114.9 volts (on a 120 volt base) as identified by circuit modeling. Based on the Aclara peak load readings the circuit connected load diversity is 65%. Therefore, this solution would shift approximately 200kVA of peak load (83 amps) off the 322X14 circuit. As a result, it will reduce loading on the primary feeder to 75% of its normal summer rating and 68% of step-down transformer nameplate rating.

Business Process and / or Technical Improvements

- Addresses overloaded primary feeder conductor.
- Addresses overloaded 500 kVA step transformer.
- Solution improves system voltage to customers at the tail end of the circuit.
- Solution allows for the installation of low side step-down transformer fusing which currently does not exist.

Alternatives Considered with Cost Estimates

Reconductor 190 ft of #2 ACSR with 477 covered conductors to address the overload primary feeder, however this solution fails to off-load 500 KVA step-down transformer to below 100% of nameplate. In addition, this solution fails to improve system voltage on the 322X14 to acceptable levels and does not allow for low side step-down fusing. Estimated Cost \$20K



Project Schedule

Milestone/Phase Name	Estimated Date
100% Engineering Completion	10/15/2020
Construction Start	03/1/2021
Testing/Commissioning	04/1/2021
In Service Date	06/01/2021

Regulatory Approvals

None

Risks and Risk Mitigation Plans

Cost could escalate due to bids or inaccurate estimate assumptions. If the project is bid and the bids are higher than anticipated, additional funding will be sought.

Goffstown is CCI's pole maintenance area which could impact scheduling or project costs if CCI declines to set poles. Operations will need to work closely with CCI to ensure the project is completed in a timely manner. If costs increase due to pole setting, supplemental funding will be sought.

Tree trimming is an unknown cost at this time. When the project is sent out to bid and the pole set question has been answered the associated trimming costs could increase the project cost.

Contingency

None

References

None

REDACTED



Attachments (One-Line Diagrams, Images, etc.)

Figure 1. 322x14 Circuit Overview

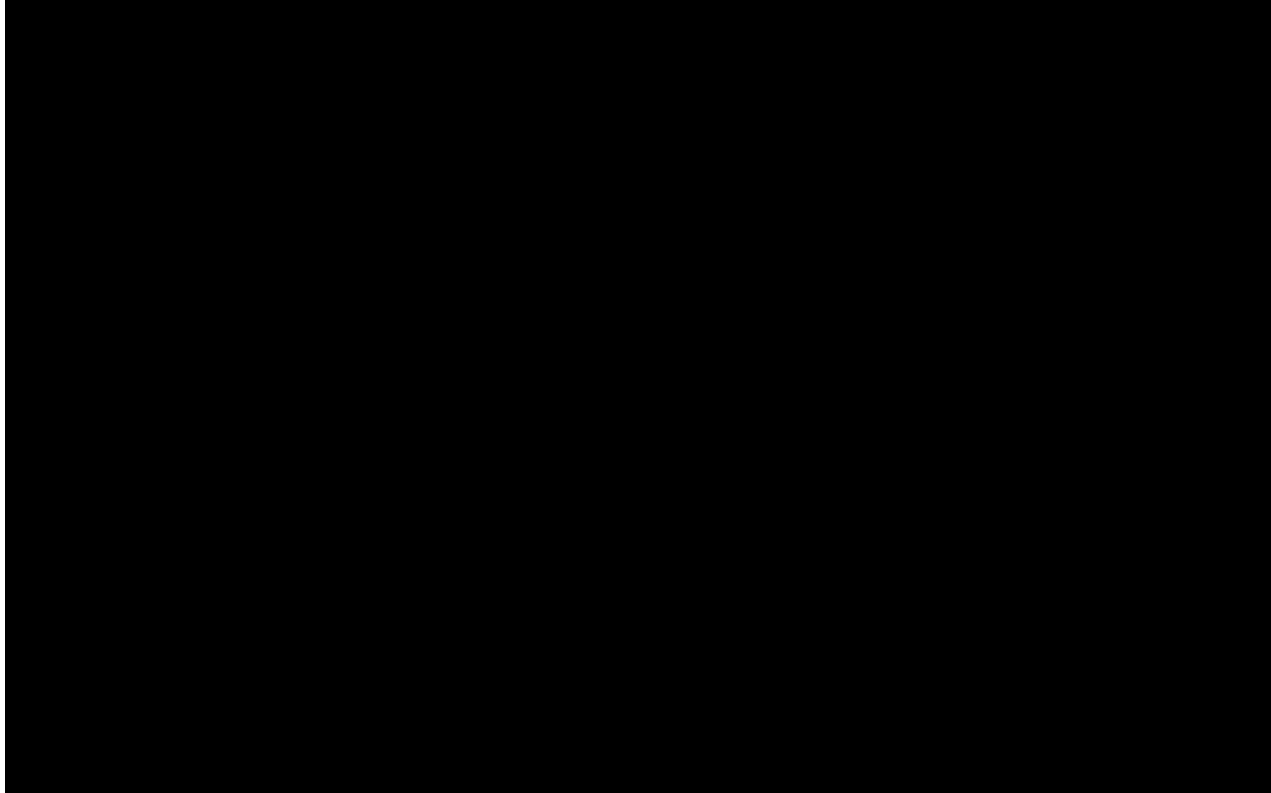
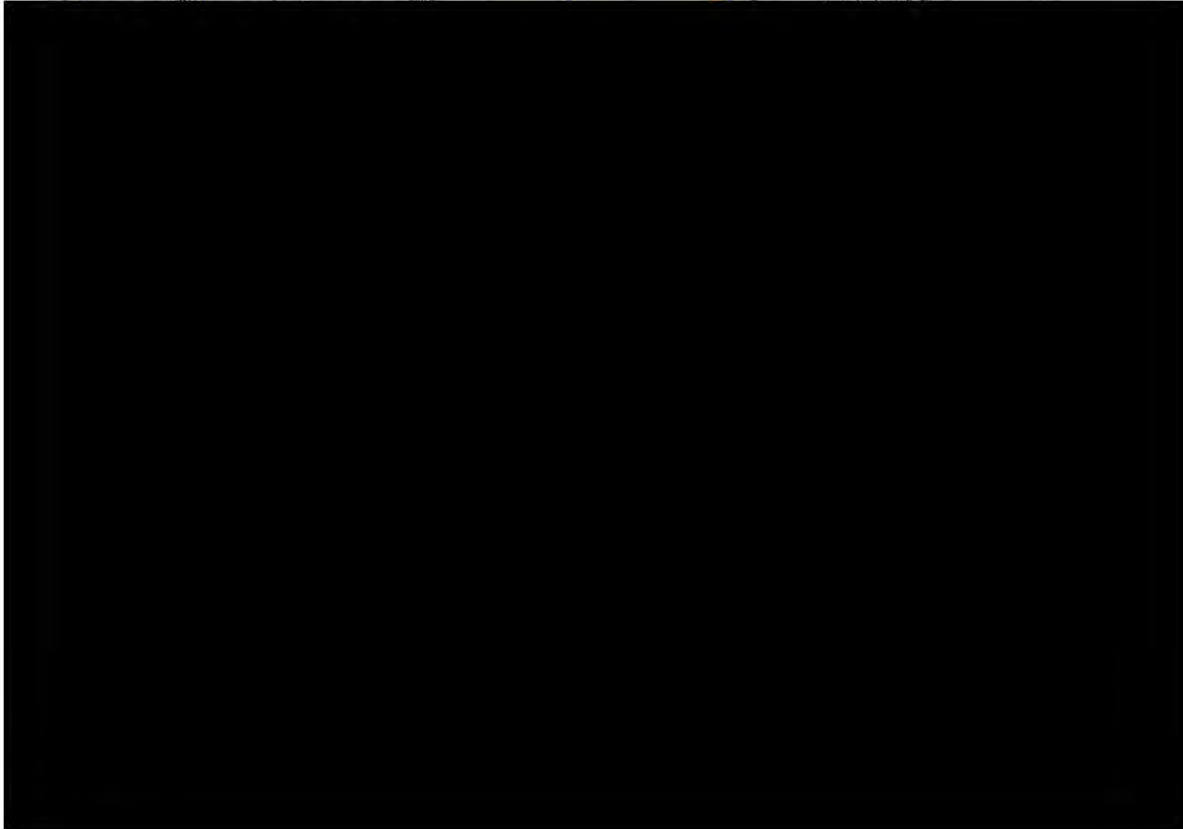



Figure 2. Project Overview



Cost Estimate Backup Details

Job has been written in Maximo, but estimate function is currently not available. Current estimate based on similar cost associated with work completed on other projects.



Operations Project Authorization Form

Date Prepared: 12/30/2020	Project Title: Reconductor New Boston Rd, Bedford
Company: Eversource NH	Project Number: A21C25
Organization: Distribution Engineering	Class(es) of Plant: D Line
Project Initiator: Michael Warren	Project Category: Lines - Conductor
Project Manager: Marc Pilotte	Project Type: Specific
Project Sponsor: Russel Johnson	Project Purpose: Loading and Load Balance
Estimated in service date: 12/15/2021	Capital Investment part of original Oper. Plan: Yes
Eng./Constr. Resources Budgeted? Yes	O&M Expenses part of original Oper. Plan: Yes
Authorization Type: Full Funding	Facility Type (check all that apply):
Total Request: \$825,000	<input type="checkbox"/> PTF <input type="checkbox"/> non-PTF <input checked="" type="checkbox"/> Distribution

Executive Summary

This project seeks \$825,000 to replace the 360X5 single phase open wire construction with three phase spacer cable along New Boston Road in Bedford NH. This work is necessary in order to balance load on the parent circuit 3194X1. Peak load readings taken the past two summers show a significant load imbalance between phases A and C on the 3194X1. The single phase 360X5 circuit in Bedford is a tap off the 3194X1 and adding phases will allow for balanced load on the 3194X1. Project will also help alleviate two different over loaded step transformers on neighboring circuits, provide an opportunity to address a load imbalance issue on the 85W1 circuit and move us closer to a 34.5 kV circuit tie between the radial 3194X1 and 322X10 circuits.



Project Costs Summary *Note: Dollar values are in thousands*

Line item Category	Prior Authorized	Actuals to Date	2020 to Go	2021	2022	2023	2024	2025	Total
1. ROW/ Easements / Land Acquisition	\$0	\$0	\$0	\$0	\$0	\$0	\$0	\$0	\$0
2. Environmental Approvals / Permits	\$0	\$0	\$0	\$0	\$0	\$0	\$0	\$0	\$0
3. Outreach	\$0	\$0	\$0	\$0	\$0	\$0	\$0	\$0	\$0
4. Siting Approvals / Permits	\$0	\$0	\$0	\$0	\$0	\$0	\$0	\$0	\$0
5. Engineering / Design	\$0	\$0	\$0	\$150	\$0	\$0	\$0	\$0	\$150
6. Materials (Eversource purchased)	\$0	\$0	\$0	\$140	\$0	\$0	\$0	\$0	\$140
7. Construction (incl mat'l's by contractors)	\$0	\$0	\$0	\$135	\$0	\$0	\$0	\$0	\$135
8. Testing / Commissioning	\$0	\$0	\$0	\$0	\$0	\$0	\$0	\$0	\$0
9. Project Mgmt Team	\$0	\$0	\$0	\$0	\$0	\$0	\$0	\$0	\$0
10. Removals	\$0	\$0	\$0	\$0	\$0	\$0	\$0	\$0	\$0
11. Other	\$0	\$0	\$0	\$0	\$0	\$0	\$0	\$0	\$0
12. Risks	\$0	\$0	\$0	\$0	\$0	\$0	\$0	\$0	\$0
SUBTOTAL DIRECTS W/ RISKS	\$0	\$0	\$0	\$425	\$0	\$0	\$0	\$0	\$425
13. Indirects/Overhead	\$0	\$0	\$0	\$393	\$0	\$0	\$0	\$0	\$393
14. AFUDC	\$0	\$0	\$0	\$7	\$0	\$0	\$0	\$0	\$7
PROJECT TOTAL – BASELINE BUDGET	\$0	\$0	\$0	\$825	\$0	\$0	\$0	\$0	\$825
15. Contingency	\$0	\$0	\$0	\$0	\$0	\$0	\$0	\$0	\$0
TOTAL CAPITAL REQUEST	\$0	\$0	\$0	\$825	\$0	\$0	\$0	\$0	\$825
16. Reimbursables/Customer Contribution	\$0	\$0	\$0	\$0	\$0	\$0	\$0	\$0	\$0
PROJECT TOTAL (LESS REIMBURSABLES)	\$0	\$0	\$0	\$825	\$0	\$0	\$0	\$0	\$825
O&M	\$0	\$0	\$0	\$0	\$0	\$0	\$0	\$0	\$0
TOTAL REQUEST	\$0	\$0	\$0	\$825	\$0	\$0	\$0	\$0	\$825

Note: Explain unique payment provisions, if applicable: *Provide a detailed breakdown of Other costs here.*



Breakout Costs

Note: Dollar values are in thousands

Line item Category	Prior Authorized	Actuals to Date	2020 to Go	2021	2022	2023	2024	2025	Total
ST Labor	\$0	\$0	\$0	\$150	\$0	\$0	\$0	\$0	\$150
OT Labor	\$0	\$0	\$0	\$0	\$0	\$0	\$0	\$0	\$0
Outside Services Labor	\$0	\$0	\$0	\$135	\$0	\$0	\$0	\$0	\$135
Materials*	\$0	\$0	\$0	\$140	\$0	\$0	\$0	\$0	\$140
Removals	\$0	\$0	\$0	\$0	\$0	\$0	\$0	\$0	\$0
Other	\$0	\$0	\$0	\$0	\$0	\$0	\$0	\$0	\$0
Indirects	\$0	\$0	\$0	\$393	\$0	\$0	\$0	\$0	\$393
AFUDC	\$0	\$0	\$0	\$7	\$0	\$0	\$0	\$0	\$7
TOTAL CAPITAL REQUEST - W/O REIMBURSABLES	\$0	\$0	\$0	\$825	\$0	\$0	\$0	\$0	\$825

*All materials including Eversource purchased and outside service purchased. Note that outside service purchased material included in construction in project cost summary above.



Future Financial Impacts:

Provide below the estimated future costs that will result from the project:

Note: Dollar values are in thousands

Future Costs	Year 20__	Year 20__	Year 20__	Year 20__ +	Total Future Project Costs
Capital	\$ -	\$ -	\$ -	\$ -	\$ -
O&M	-	-	-	-	-
Other	-	-	-	-	-
TOTAL	\$ -	\$ -	\$ -	\$ -	\$ -

Describe the estimated future Capital, O&M, and/or Other costs noted above:

What functional area(s) will these future costs be funded in? _____

A representative from the respective functional area is required to be included as a project approver.

Provide below the estimated future financial benefits that will result from the project:

Note: Dollar values are in thousands

Future Benefits	Year 20__	Year 20__	Year 20__	Year 20__ +	Total Future Project Benefits
Capital	\$ -	\$ -	\$ -	\$ -	\$ -
O&M	-	-	-	-	-
Other	-	-	-	-	-
TOTAL	\$ -	\$ -	\$ -	\$ -	\$ -

Describe the estimated future Capital, O&M, and/or Other benefits noted above:

What functional area(s) will these benefits be reflected in? _____

A representative from the respective functional area is required to be included as a project approver.

Asset Retirement Obligation (ARO) and/ or Environmental Cleanup Costs (Environmental Liabilities):

Is there an ARO associated with this project? No.

Are there other environmental cleanup costs associated with this project? No

EVERSOURCE

Project Authorization Form

Technical Justification

Project Need Statement

The 3194X1 SCADA controlled recloser identified peak load readings of 100A, 163A, 181A respectively during summer 2020. The 360X5 single-phase circuit accounts for 65% (118A) of phase C load on the 3194X1. In addition, there is a set of parallel 500 KVA steps on phase B of the 360X7 which line sensors show reached 96% of nameplate during summer peak after two emergency load swaps were performed. Phase C on the 360X7 has only a single 500 KVA step with room for additional load, however, due to the 3194X1 load imbalance it can't be utilized to off load phase B. Construction is currently underway on the 360X5 for 50 additional homes off Pulpit/Indian Rock Roads and sporadic growth continues on the 360X7 circuit due to new home construction along Indian Falls Road, Wilson Farm Road and Foxberry Drive. This solution also provides an opportunity to address load imbalance and equipment overloads on the 360X7 and 85W1 circuits.

Project Objectives

Improved load balance on the 3194X1 parent circuit, addresses new residential load growth currently under construction on the 360X5 circuit and moves us closer to completing a circuit tie between the 3194X1 and 322X10 circuits. Finally, this project will provide an opportunity to balance load and address equipment overloads on both the 360X7 and 360X5 circuits.

Project Scope

Reconductor approximately 4,752 feet of single phase #2 ACSR with three phase 477 spacer cable from the start of the 360X5 circuit to Walsch Rd (pole 25/250). Redistribute load from phase C to two new phases. Replace single phase Spear recloser at start of circuit with Nova (SCADA controlled) recloser. Re-balance load on the 360X5.

Background / Justification

This project would help solve several issues and move closer to establishing a circuit tie for 3,308 customers on the 3194X1 and 322X10 radial feeds.

1. There is a severe load imbalance on the 3194X1, 34.5 kV circuit, with phase C being the heaviest loaded phase and the 360X5 accounting for 65% of that load.
2. There is currently a new residential 50 lot development (homes in the 3000 – 3500 sq.-ft range) being built on the 360X5 in the vicinity of Pulpit Road which will add more load to phase C increasing the load imbalance on the 3194X1.
3. The phase C single 500 KVA step on the 360X7 is currently under-utilized while the phase B parallel 500 KVA steps are at 96% of nameplate, but only after two emergency off-loads this past summer. There are currently new residential homes being built in various developments on this circuit with the phase B step loading seeing a 7% increase between summer 2019 and 2020.
4. This project will provide an opportunity to address circuit deficiencies on the 85W1 circuit in New Boston which include a load imbalance, an overloaded hydraulic recloser and overloaded 167 kVA step transformer as this circuit backs up to the 360X7.
5. Finally, the radially fed 3194X1 and 322X10 circuits currently feed 3,308 customers (including the New Boston Tracking Station and Riddle Brook School) with no back feed available. Completion of this project will work to establishing a circuit tie for these circuits/customers and improve reliability.

Business Process and / or Technical Improvements

- Addresses continued load growth in the towns of Bedford and New Boston.
- Balancing load out on the 3194X1 circuit will help improve system voltage.
- Works towards completion of a circuit tie between the radial 3194X1 and the 322X10 circuits has been requested by operations and proposed for many years.

EVERSOURCE

Project Authorization Form

- Replacing open wire single phase construction with three phase spacer cable construction along New Boston Road in Bedford will result in system hardening thereby improving reliability.

Alternatives Considered with Cost Estimates

1. Convert the tail end of the 322X10 and transfer load from the 360X5 at a cost of less than \$100k. This alternative, which is currently under construction, is a short-term solution which only helps balance load on the 3194X1. It does not address known load growth associated with new residential home construction in progress on the 360X5 and 360X7 circuits. It does not help address loading on the parallel 500 kVA steps on the 360X7 circuit which reached 96% of nameplate rating during summer 2020, nor does it address high growth rate in this area of New Boston. This solution provides no opportunities to address load imbalance and equipment overloads on the 85W1 circuit. It also does not work towards establishing a circuit tie between the 3194X1 and 322X10 circuits.
2. 360X7 – Multiphase down McCurdy Rd approximately 1,230 feet to off load approximately 20 amps of peak loading at a cost \$220K. This alternative helps address the overloaded parallel 500 kVA steps on the 360X7 circuit and provide a slight improvement with load balancing on the 3194X1. It does not address high loading on the 360X5 single phase radial circuit (2.3MW peak) nor does it address new load under construction on the 360X5 circuit. It also does not work towards establishing a circuit tie between the 3194X1 and 322X10 circuits.

Project Schedule

Milestone/Phase Name	Estimated Date
100% Engineering Completion	03/01/2021
Construction Start	05/01/2021
In Service Date	06/15/2021

Regulatory Approvals

None

Risks and Risk Mitigation Plans

Cost could escalate due to bids or inaccurate estimate assumptions. Goffstown is CCI's pole maintenance area and if they decline to set poles it could increase costs. Either of these may result in the need to request supplemental funding, which will be sought prior to commencing construction.

Contingency

None

References

None

REDACTED
EVERSOURCE
Project Authorization Form

Attachments (One-Line Diagrams, Images, etc.)

Figure 1. 360X5 Circuit Overview.

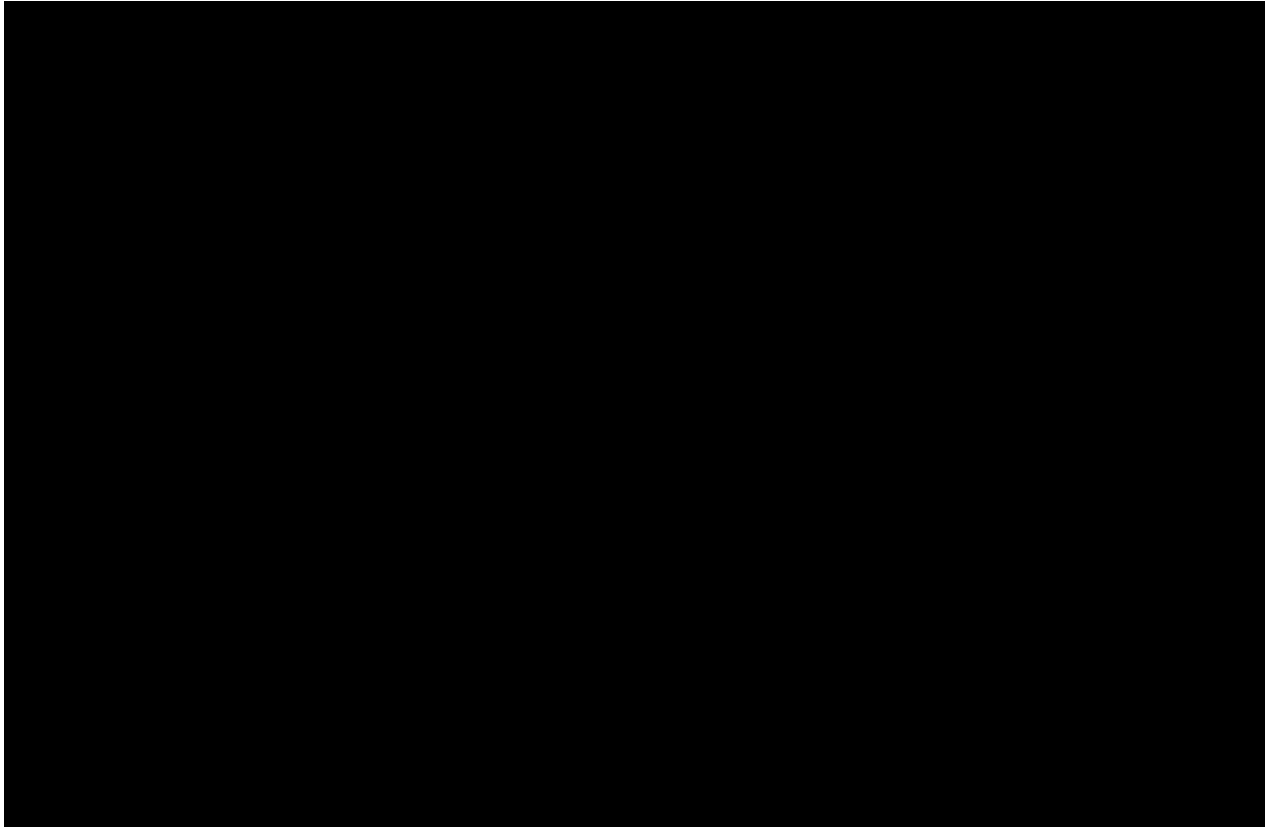

REDACTED

EVERSOURCE
Project Authorization Form

Figure 1. 360X7 Circuit Overview.

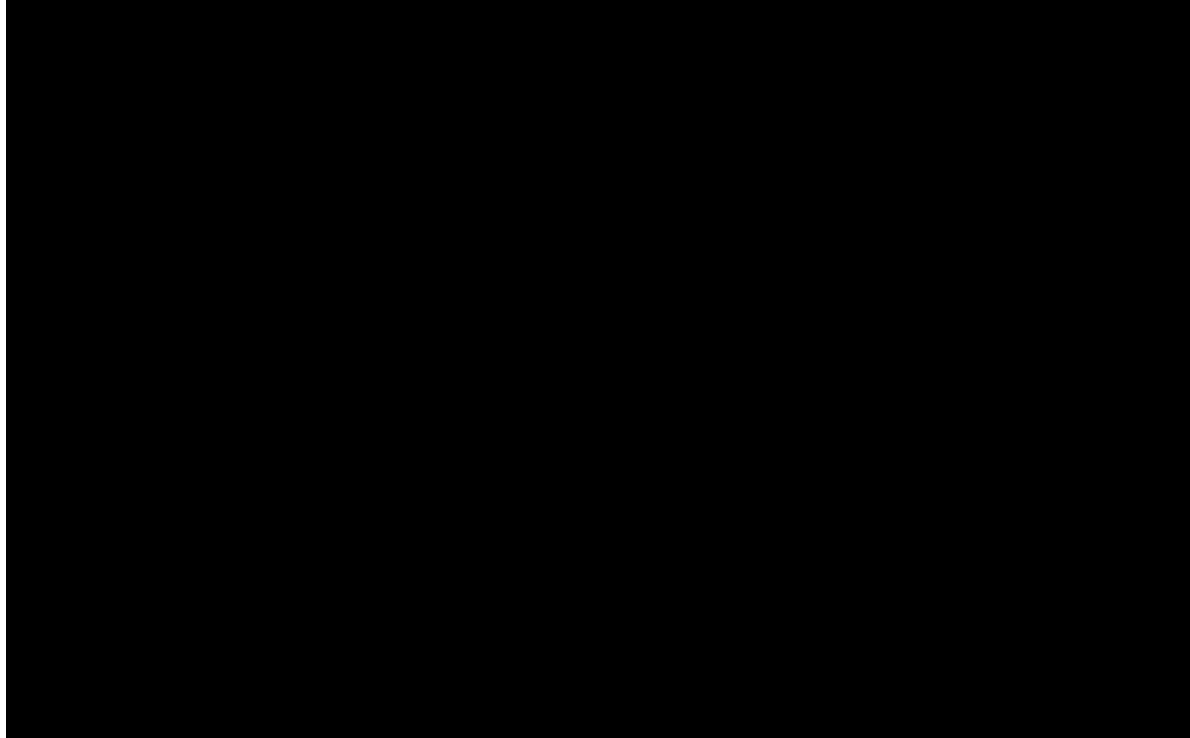

Cost Estimate Backup Details

Job has been written in Maximo, but estimate function is currently not available. Project cost based on engineering estimate using the following assumptions:

- Three Phase reconductor with 477 spacer cable - \$160 per foot.
- Single Phase reconductor with 1/0 covered - \$106 per foot.



Operations Project Authorization Form

Date Prepared: 02/10/2021	Project Title: Westland Ave Conversion
Company: Eversource NH	Project Number: A21C42
Organization: Distribution Engineering	Class(es) of Plant: D Line
Project Initiator: Bob Krewson	Project Category: Lines - Conductor
Project Manager: Marc Pilotte	Project Type: Specific
Project Sponsor: Russel Johnson	Project Purpose: Conversion due to overloaded step transformer
Estimated in service date: June 1, 2021	Capital Investment part of original Oper. Plan: No
Eng./Constr. Resources Budgeted? No	O&M Expenses part of original Oper. Plan: No
Authorization Type: Full Funding	Facility Type (check all that apply):
Total Request: \$261,000	<input type="checkbox"/> PTF <input type="checkbox"/> non-PTF <input checked="" type="checkbox"/> Distribution

Executive Summary

This work addresses the 124% loaded 333 kva step-down transformer (7.2-2.4 kv) on Westland Ave in Manchester. The step transformer relocation will require conversion of 1,725 feet of 1Ø line (including two side taps) on the 14W1 circuit. The projected loading on the relocated step transformer will be 86%. The peak loading of 172 amps on the #6 Cu primary exceeds its emergency rating (summer normal/emergency = 130/155 A), thus precluding a step upgrade from 333 to 500 kva at the present step location. The cost for this work is estimated at \$261k.



Project Costs Summary *Note: Dollar values are in thousands*

Line item Category	Prior Authorized	Actuals to Date	2020 to Go	2021	2022	2023	2024	2025	Total
1. ROW/ Easements / Land Acquisition	\$0	\$0	\$0	\$0	\$0	\$0	\$0	\$0	\$0
2. Environmental Approvals / Permits	\$0	\$0	\$0	\$0	\$0	\$0	\$0	\$0	\$0
3. Outreach	\$0	\$0	\$0	\$0	\$0	\$0	\$0	\$0	\$0
4. Siting Approvals / Permits	\$0	\$0	\$0	\$0	\$0	\$0	\$0	\$0	\$0
5. Engineering / Design	\$0	\$0	\$0	\$0	\$0	\$0	\$0	\$0	\$0
6. Materials (Eversource purchased)	\$0	\$0	\$0	\$35	\$0	\$0	\$0	\$0	\$35
7. Construction (incl mat'l's by contractors)	\$0	\$0	\$0	\$70	\$0	\$0	\$0	\$0	\$70
8. Testing / Commissioning	\$0	\$0	\$0	\$0	\$0	\$0	\$0	\$0	\$0
9. Project Mgmt Team	\$0	\$0	\$0	\$0	\$0	\$0	\$0	\$0	\$0
10. Removals	\$0	\$0	\$0	\$10	\$0	\$0	\$0	\$0	\$10
11. Other	\$0	\$0	\$0	\$0	\$0	\$0	\$0	\$0	\$0
12. Risks	\$0	\$0	\$0	\$0	\$0	\$0	\$0	\$0	\$0
SUBTOTAL DIRECTS W/ RISKS	\$0	\$0	\$0	\$115	\$0	\$0	\$0	\$0	\$115
13. Indirects/Overhead	\$0	\$0	\$0	\$145	\$0	\$0	\$0	\$0	\$145
14. AFUDC	\$0	\$0	\$0	\$1	\$0	\$0	\$0	\$0	\$1
PROJECT TOTAL - BASELINE BUDGET	\$0	\$0	\$0	\$261	\$0	\$0	\$0	\$0	\$261
15. Contingency	\$0	\$0	\$0	\$0	\$0	\$0	\$0	\$0	\$0
TOTAL CAPITAL REQUEST	\$0	\$0	\$0	\$261	\$0	\$0	\$0	\$0	\$261
16. Reimbursables/Customer Contribution	\$0	\$0	\$0	\$0	\$0	\$0	\$0	\$0	\$0
PROJECT TOTAL (LESS REIMBURSABLES)	\$0	\$0	\$0	\$261	\$0	\$0	\$0	\$0	\$261
O&M	\$0	\$0	\$0	\$0	\$0	\$0	\$0	\$0	\$0
TOTAL REQUEST	\$0	\$0	\$0	\$261	\$0	\$0	\$0	\$0	\$261

Note: Explain unique payment provisions, if applicable: *Provide a detailed breakdown of Other costs here.*



Breakout Costs

Note: Dollar values are in thousands

Line item Category	Prior Authorized	Actuals to Date	2020 to Go	2021	2022	2023	2024	2025	Total
ST Labor	\$0	\$0	\$0	\$55	\$0	\$0	\$0	\$0	\$55
OT Labor	\$0	\$0	\$0	\$0	\$0	\$0	\$0	\$0	\$0
Outside Services Labor	\$0	\$0	\$0	\$15	\$0	\$0	\$0	\$0	\$15
Materials*	\$0	\$0	\$0	\$35	\$0	\$0	\$0	\$0	\$35
Removals	\$0	\$0	\$0	\$10	\$0	\$0	\$0	\$0	\$10
Other	\$0	\$0	\$0	\$0	\$0	\$0	\$0	\$0	\$0
Indirects	\$0	\$0	\$0	\$145.0	\$0	\$0	\$0	\$0	\$145
AFUDC	\$0	\$0	\$0	\$1.0	\$0	\$0	\$0	\$0	\$1
TOTAL CAPITAL REQUEST - W/O REIMBURSABLES	\$0	\$0	\$0	\$261	\$0	\$0	\$0	\$0	\$261

*All materials including Eversource purchased and outside service purchased. Note that outside service purchased material included in construction in project cost summary above.



Future Financial Impacts:

Provide below the estimated future costs that will result from the project:

Note: Dollar values are in thousands

Future Costs	Year 20__	Year 20__	Year 20__	Year 20__ +	Total Future Project Costs
Capital	\$ -	\$ -	\$ -	\$ -	\$ -
O&M	-	-	-	-	-
Other	-	-	-	-	-
TOTAL	\$ -	\$ -	\$ -	\$ -	\$ -

Describe the estimated future Capital, O&M, and/or Other costs noted above:

What functional area(s) will these future costs be funded in? _____
A representative from the respective functional area is required to be included as a project approver.

Provide below the estimated future financial benefits that will result from the project:

Note: Dollar values are in thousands

Future Benefits	Year 20__	Year 20__	Year 20__	Year 20__ +	Total Future Project Benefits
Capital	\$ -	\$ -	\$ -	\$ -	\$ -
O&M	-	-	-	-	-
Other	-	-	-	-	-
TOTAL	\$ -	\$ -	\$ -	\$ -	\$ -

Describe the estimated future Capital, O&M, and/or Other benefits noted above:

What functional area(s) will these benefits be reflected in? _____
A representative from the respective functional area is required to be included as a project approver.

Asset Retirement Obligation (ARO) and/ or Environmental Cleanup Costs (Environmental Liabilities):

Is there an ARO associated with this project? No

Are there other environmental cleanup costs associated with this project? No



Technical Justification

Project Need Statement

The 2020 peak load on the Westland Ave 333 kva step-down transformer was at 124% of its rating. At 2.4 kv, this 172-amp load significantly exceeds the rating of the #6 Cu downstream primary conductor (normal/emergency = 130/155 A).

Project Objectives

Relocate the 333 kva transformer 450 feet downstream of its present location in order to reduce peak loading to 86% of its rating. This will require conversion of 1,725 feet of circuit including two small side-taps.

Project Scope

Convert 1,725 feet of circuit from 2.4 to 7.2 kv as well as re-conductor 1,300 feet of #6 Cu primary with 1/0 ACSR. The step-down transformer will be relocated 450 feet downstream of its present location. The #6 primary normal rating precludes the upgrading of the 333 kva with a 500 kva transformer at its present location.

Background / Justification

The 2020 summer peak loading put the Westland Avenue 333 kva step transformer at 124% of its rating. Conversion of this portion of the circuit and relocation of the transformer will reduce loading to 86% of its rating. The #6 Cu primary conductor was overloaded at 132% of its normal summer rating. Reconductoring Westland Avenue to Dunbar St (some 300 feet beyond the relocated step) will eliminate any conductor overloading (the 1/0 ACSR will be at 68% of its rating).

Business Process and / or Technical Improvements

This work will replace 1,300 feet of #6 Cu primary with 1/0 ACSR. In addition, it will upgrade just under ten poles as well as replace several pre-1970s transformers and a number of units with arc-gap arrestors.

Alternatives Considered with Cost Estimates

One alternative considered was to extend primary 650 feet on West Mitchell St so that it could feed the back end of the 333 kva step area on Riverdale Ave. A 250 kva transformer at this location would thereby reduce loading on the 333 kva step to 75% of its rating. The cost of this work is estimated at \$125k. However:

1. The need for licensing the railroad crossing would likely mean the June 1 deadline could not be met.
2. This work would increase total system circuit exposure due to the addition of primary line and poles that presently do not exist.
3. This money could be better spent upgrading existing, older facilities (bringing them up to standards), which otherwise would remain in place.

Project Schedule

Milestone/Phase Name	Estimated Date
100% Engineering Completion	March 15, 2021
Construction Start	April 15, 2021
In Service Date	June 1, 2021

Regulatory Approvals

1. Additional of one pole for the relocated step-transformer is subject to City of Manchester approval.

REDACTED

EVERSOURCE
Project Authorization Form

2. It will be necessary to contact the railroad for reconductoring work in its right-of-way (this will most likely require a railroad flagger).

Risks and Risk Mitigation Plans

1. This is an ES pole set area, so pole work is not dependent upon CCI work.
2. The ideal location for the relocated step transformer is new pole 1236/12Y on Westland Ave. The City of Manchester assessor's maps seem to indicate sufficient road width for setting this pole. Should it prove otherwise, the step transformer would need to be relocated to Dunbar St.

Contingency

None.

References

None.

Attachments (One-Line Diagrams, Images, etc.)

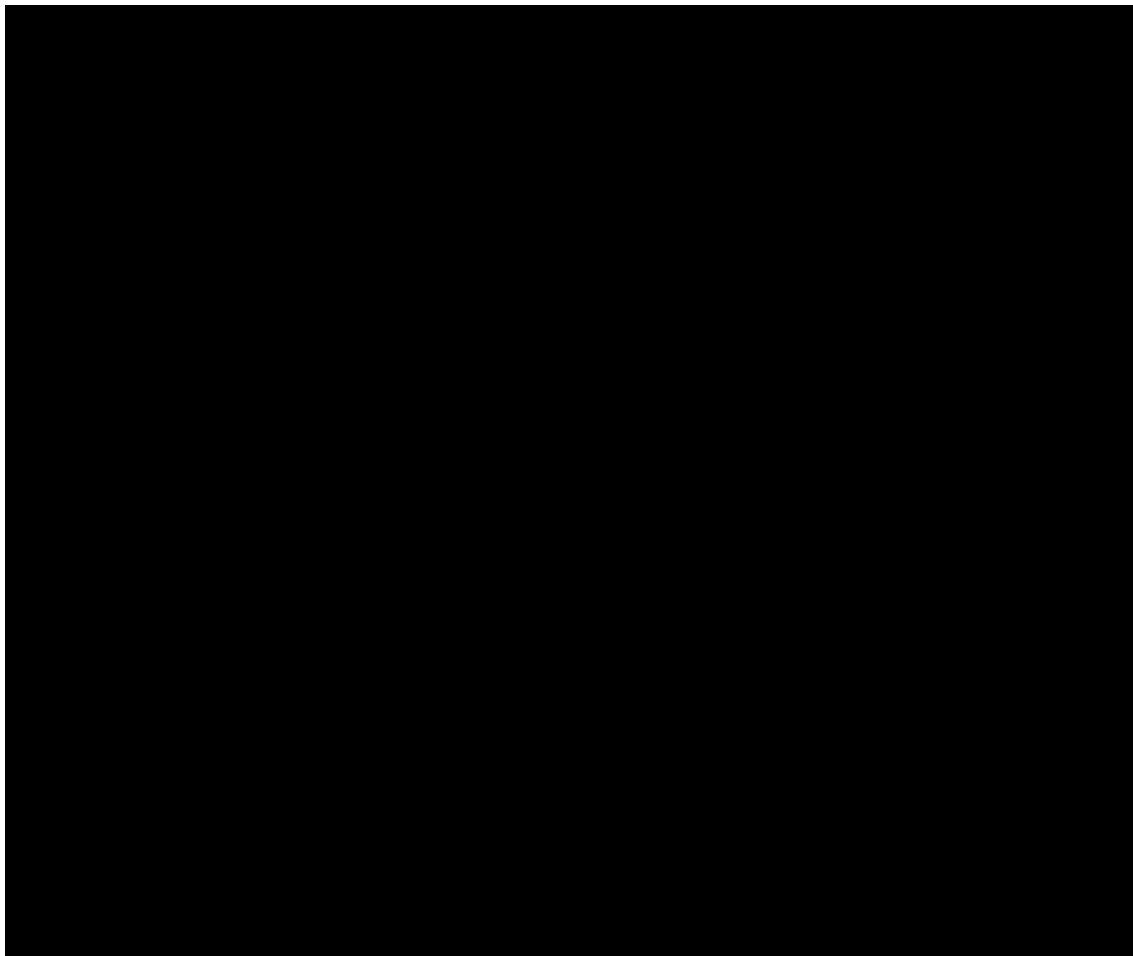



Operations Project Authorization Form

Date Prepared: 01/01/2021	Project Title: 3191X1B – 377X2 Circuit Tie
Company: Eversource NH	Project Number: A21E08
Organization: Distribution Engineering	Class(es) of Plant: D Line
Project Initiator: Paul Bednarz	Project Category: Lines - General
Project Manager: Michael Busby	Project Type: Specific
Project Sponsor: Russell Johnson	Project Purpose: Create Circuit Tie for Radial 3191X1B Circuit
Estimated in service date: 6/1/2021	Capital Investment part of original Oper. Plan: Yes
Eng./Constr. Resources Budgeted? Yes	O&M Expenses part of original Oper. Plan: Yes
Authorization Type: Full Funding	Facility Type (check all that apply):
Total Request: \$551,000	<input type="checkbox"/> PTF <input type="checkbox"/> non-PTF <input checked="" type="checkbox"/> Distribution

Executive Summary

This project authorization form is requesting \$551,000 to create a new circuit tie between the 3191X1B and the 377X2. The 3191X1B is a radial circuit feeding 1178 customers, which experiences on average one fault on the backbone each year impacting the whole circuit. This project will reconductor and convert 19 spans (2300') of the 377X2 on Exeter Rd to create a new 34.5 kV circuit tie between the 3191X1B and the 377X2 on Bennett way in Newmarket, allowing us to back feed 869 customers on the 3191X1B from the 377 line.

This project results in a cost saved per customer minute of \$2.20.



Project Costs Summary *Note: Dollar values are in thousands*

Line item Category	Prior Authorized	Actuals to Date	2020 to Go	2021	2022	2023	2024	2025	Total
1. ROW/ Easements / Land Acquisition	\$0	\$0	\$0	\$0	\$0	\$0	\$0	\$0	\$0
2. Environmental Approvals / Permits	\$0	\$0	\$0	\$0	\$0	\$0	\$0	\$0	\$0
3. Outreach	\$0	\$0	\$0	\$0	\$0	\$0	\$0	\$0	\$0
4. Siting Approvals / Permits	\$0	\$0	\$0	\$0	\$0	\$0	\$0	\$0	\$0
5. Engineering / Design	\$0	\$0	\$0	\$0	\$0	\$0	\$0	\$0	\$0
6. Materials (Eversource purchased)	\$0	\$0	\$0	\$99	\$0	\$0	\$0	\$0	\$99
7. Construction (incl mat'l's by contractors)	\$0	\$0	\$0	\$166	\$0	\$0	\$0	\$0	\$166
8. Testing / Commissioning	\$0	\$0	\$0	\$0	\$0	\$0	\$0	\$0	\$0
9. Project Mgmt Team	\$0	\$0	\$0	\$0	\$0	\$0	\$0	\$0	\$0
10. Removals	\$0	\$0	\$0	\$12	\$0	\$0	\$0	\$0	\$12
11. Other	\$0	\$0	\$0	\$0	\$0	\$0	\$0	\$0	\$0
12. Risks	\$0	\$0	\$0	\$0	\$0	\$0	\$0	\$0	\$0
SUBTOTAL DIRECTS W/ RISKS	\$0	\$0	\$0	\$277	\$0	\$0	\$0	\$0	\$277
13. Indirects/Overhead	\$0	\$0	\$0	\$262	\$0	\$0	\$0	\$0	\$262
14. AFUDC	\$0	\$0	\$0	\$12	\$0	\$0	\$0	\$0	\$12
PROJECT TOTAL - BASELINE BUDGET	\$0	\$0	\$0	\$551	\$0	\$0	\$0	\$0	\$551
15. Contingency	\$0	\$0	\$0	\$0	\$0	\$0	\$0	\$0	\$0
TOTAL CAPITAL REQUEST	\$0	\$0	\$0	\$551	\$0	\$0	\$0	\$0	\$551
16. Reimbursables/Customer Contribution	\$0	\$0	\$0	\$0	\$0	\$0	\$0	\$0	\$0
PROJECT TOTAL (LESS REIMBURSABLES)	\$0	\$0	\$0	\$551	\$0	\$0	\$0	\$0	\$551
O&M	\$0	\$0	\$0	\$0	\$0	\$0	\$0	\$0	\$0
TOTAL REQUEST	\$0	\$0	\$0	\$551	\$0	\$0	\$0	\$0	\$551

Note: Explain unique payment provisions, if applicable: *Provide a detailed breakdown of Other costs here.*



Breakout Costs

Note: Dollar values are in thousands

Line item Category	Prior Authorized	Actuals to Date	2020 to Go	2021	2022	2023	2024	2025	Total
ST Labor	\$0	\$0	\$0	\$136	\$0	\$0	\$0	\$0	\$136
OT Labor	\$0	\$0	\$0	\$0	\$0	\$0	\$0	\$0	\$0
Outside Services Labor	\$0	\$0	\$0	\$30	\$0	\$0	\$0	\$0	\$30
Materials*	\$0	\$0	\$0	\$99	\$0	\$0	\$0	\$0	\$99
Removals	\$0	\$0	\$0	\$12	\$0	\$0	\$0	\$0	\$12
Other	\$0	\$0	\$0	\$0	\$0	\$0	\$0	\$0	\$0
Indirects	\$0	\$0	\$0	\$262	\$0	\$0	\$0	\$0	\$262
AFUDC	\$0	\$0	\$0	\$12	\$0	\$0	\$0	\$0	\$12
TOTAL CAPITAL REQUEST - W/O REIMBURSABLES	\$0	\$0	\$0	\$551	\$0	\$0	\$0	\$0	\$551

*All materials including Eversource purchased and outside service purchased. Note that outside service purchased material included in construction in project cost summary above.



Future Financial Impacts:

Provide below the estimated future costs that will result from the project:

Note: Dollar values are in thousands

Future Costs	Year 20__	Year 20__	Year 20__	Year 20__ +	Total Future Project Costs
Capital	\$ -	\$ -	\$ -	\$ -	\$ -
O&M	-	-	-	-	-
Other	-	-	-	-	-
TOTAL	\$ -	\$ -	\$ -	\$ -	\$ -

Describe the estimated future Capital, O&M, and/or Other costs noted above:

What functional area(s) will these future costs be funded in? _____
A representative from the respective functional area is required to be included as a project approver.

Provide below the estimated future financial benefits that will result from the project:

Note: Dollar values are in thousands

Future Benefits	Year 20__	Year 20__	Year 20__	Year 20__ +	Total Future Project Benefits
Capital	\$ -	\$ -	\$ -	\$ -	\$ -
O&M	-	-	-	-	-
Other	-	-	-	-	-
TOTAL	\$ -	\$ -	\$ -	\$ -	\$ -

Describe the estimated future Capital, O&M, and/or Other benefits noted above:

What functional area(s) will these benefits be reflected in? _____
A representative from the respective functional area is required to be included as a project approver.

Asset Retirement Obligation (ARO) and/ or Environmental Cleanup Costs (Environmental Liabilities):

Is there an ARO associated with this project? **No**

Are there other environmental cleanup costs associated with this project? **No**



Technical Justification

Project Need Statement

The 3191X1B and 377X2 were ranked 22 and 32 respectfully on the 2019 hitlist. Based on the past five-year outage history, we have one outage a year impacting the whole circuit, resulting in 1178 customers out of power for the duration. By converting a section of the 377X2 (See map on page 6), we will provide a back feed for the 3191X1B, and a back feed for the 104 customers converted on the 377X2. This project also removes #4 CU conductor from the 34.5 kV system.

Project Objectives

This project will accomplish the following:

- Create interconnection between the 3191X1B and the 377X2.
- Improve reliability of the 3191X1B and 377X2 by creating a back feed.
- Eliminates a radial circuit 3191X1B, feeding 1278 customers.
- Install 3 new SCADA controlled DA devices to allow ESCC to remotely restore customers.
- Removes two step transformers and relocates one step transformer.

Project Scope

This project will complete the following:

- Conversion of the 377X2 from 4.16 kV to 34.5 kV
 - o Conversion of 2 pad mount transformers to 34.5 kV
 - o Conversion of 10 overhead transformers to 19.9 kV
 - o Install new 1- 19.9kV/2.4 kV 333 kVA step transformer downline to P5/32 & P5A/2
 - o Remove hydraulic recloser, replace with TripSaver.
 - o Reconductor 950' of 3-#4 Cu, with 3-1/0 spacer cable from P5/25 to P5/31
 - o Reconductor 1350' of 3-#4 Cu with 477 spacer cable from P5/12 on Exeter Rd to P57/1 Bennett Way
- Install new NOVA normally open circuit tie point on Bennett Rd, Newmarket
- Replace Tripsaver on P5/62 on Hersey Lane with DA device.
- Replace Tripsaver on P55/14 on Bennett Way with DA device.

Background / Justification

The 3191X1B and 377X2 were ranked 22 and 32 on the 2019 hitlist. Based on the past five-year outage history, we have one outage a year impacting the whole 3191X1B circuit, resulting in 1178 customers out of power for the duration. The 3191X1B dead ends on Bennett way, Newmarket, adjacent to the tail end of the 377X2, a 2.4 kV radial step-down area. This project initially was proposed at \$175,000. During the field survey, it was discovered that the primary conductor on Exeter Rd downline from the current step position was actually #4 Cu, not #2 ACSR, so reconductoring 1350' of 3-#4 Cu with 477 SPCA from P5/12 on Exeter Rd to P57/1 Bennett Way was required, increasing the project cost by \$216,000. To reduce project costs, Terrace Drive will not be converted, a step-down transformer will feed this area instead. DA devices were also included in the cost, raising the price by \$240,000.

Business Process and / or Technical Improvements

This project eliminates a radial feed, feeding 1278 customers, allowing remote switching to restore power. This project will reconductor copper primary conductor on Exeter Rd requiring us to replace poles to maintain proper height and class, thus storm hardening the backbone with new poles and 477 SPCA. This project also involves replacing tripsavers on the 3191X1B with Nova reclosers, allowing us to back feed via SCADA switching.

Alternatives Considered with Cost Estimates

None.



Project Schedule

Milestone/Phase Name	Estimated Date
100% Engineering Completion	Complete
Construction Start	6/1/2021
In Service Date	8/1/2021

Regulatory Approvals

None

Risks and Risk Mitigation Plans

Cost could escalate due to bids or inaccurate estimate assumptions. If the project is bid and the bids are higher than anticipated, additional funding will be sought.

Contingency

None

References

None

REDACTED



Attachments (One-Line Diagrams, Images, etc.)

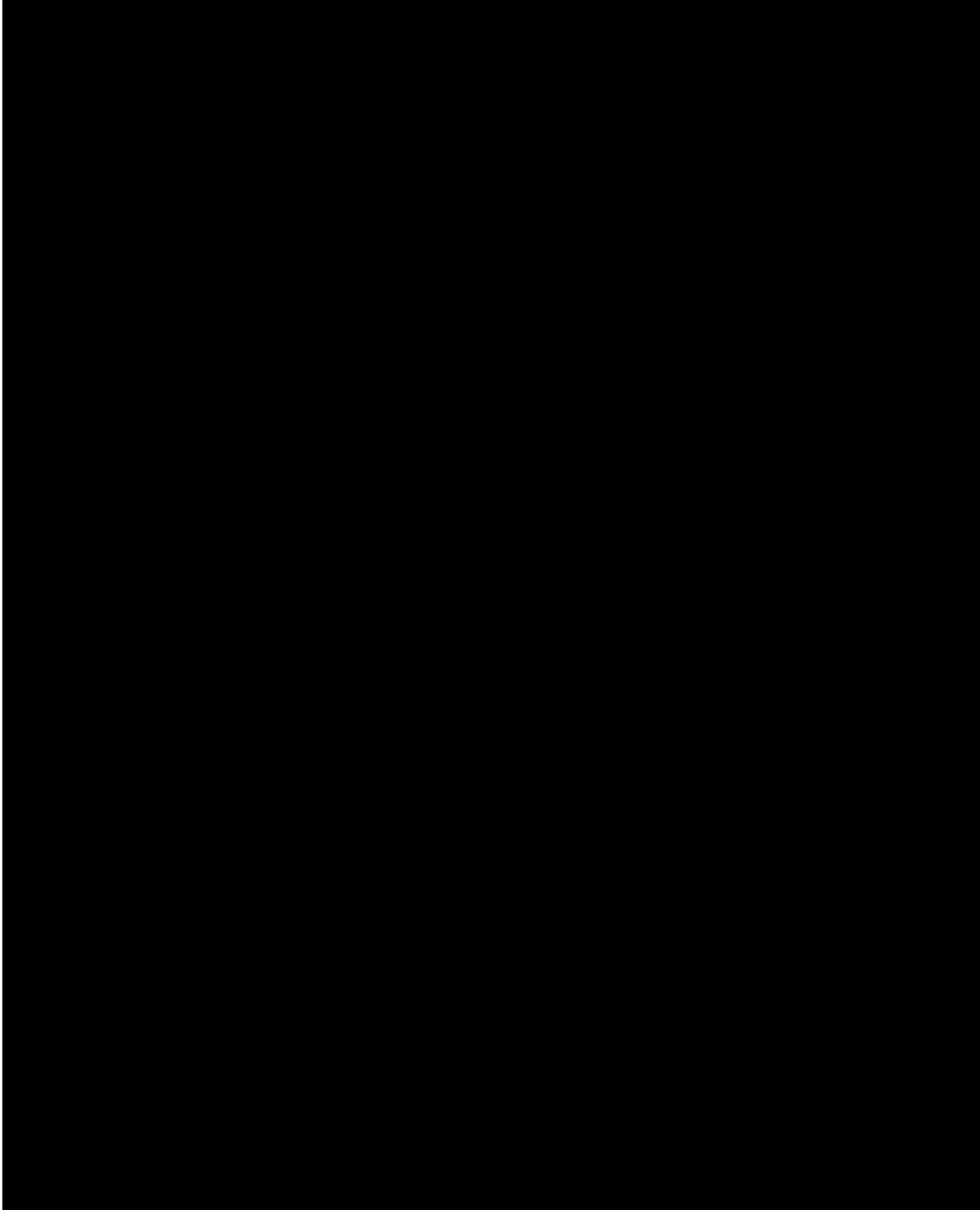



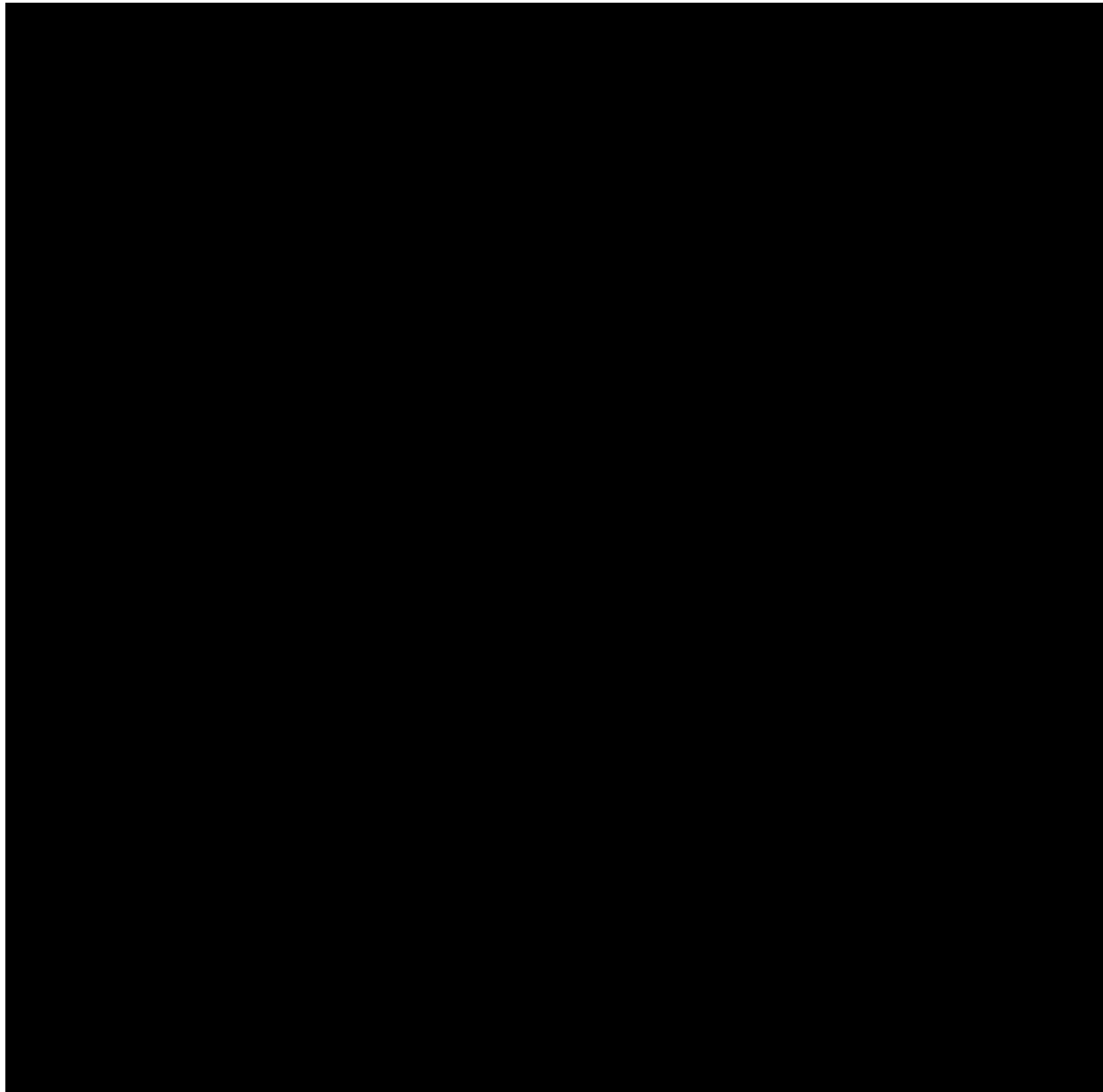

Cost Estimate Backup Details

Reconductor/convert 950' 5 spans 3#4 Cu with 3-1/0 AL SPCA – 950' * 100\$ = \$95,000
Reconductor/convert 1350' 13 spans 3#4 Cu with 3-477 SPCA – 1350' * 160\$ = \$216,000
Install three DA devices, P5/62 on Hersey Ln, P55/14 Bennett Way, & P57/1 Bennett Way = \$80,000 * 3 = \$240,000
Total: \$551,000



Operations Project Authorization Form

Date Prepared: 07/23/2020	Project Title: 3191 – 3191X3 Tie
Company: Eversource NH	Project Number: A21E09
Organization: Distribution Engineering	Class(es) of Plant: D Line
Project Initiator: Paul Grace	Project Category: Lines - General
Project Manager: Michael Busby	Project Type: Specific
Project Sponsor: Russel Johnson	Project Purpose: Create a Tie for Radially Fed 3191X3
Estimated in service date: 12/31/2021	Capital Investment part of original Oper. Plan: Yes
Eng./Constr. Resources Budgeted? Yes	O&M Expenses part of original Oper. Plan: Yes
Authorization Type: Full Funding	Facility Type (check all that apply):
Total Request: \$495,000	<input type="checkbox"/> PTF <input type="checkbox"/> non-PTF <input checked="" type="checkbox"/> Distribution

Executive Summary

This PAF is requesting \$495,000 to create a circuit tie between the radially fed 3191X3 and the 3191 mainline in the Portsmouth AWC along Post Rd in Greenland, NH.

In order to tie these two circuits together 1,700 feet of the 3112X4 circuit will be converted from 4.16kV to 34.5kV. This tie will give will allow for increased sectionalizing, along with another mainline tap, to pick up customers during contingencies. The 3191X3 has a history of outages with long restoration times. This project installs 9 new 34.5kV overhead transformers along with 1,700 feet of 1/0 spacer cable. This tie creates a backup for 1564 customers on the 3191X3 and for the 36 customers being converted on the 3112X4. This project would also set up a future tie between the 3191X3 and the 3112 and allow for the removal of 34.5kV – 4.16kV, 500 kVA step transformers. This project was recommended by operations and is a tie for a large radially fed circuit. The project will also add two DA devices for switching. The cost per customer minute saved in \$4.86.



Project Costs Summary *Note: Dollar values are in thousands*

Line item Category	Prior Authorized	Actuals to Date	2020 to Go	2021	2022	2023	2024	2025	Total
1. ROW/ Easements / Land Acquisition	\$0	\$0	\$0	\$0	\$0	\$0	\$0	\$0	\$0
2. Environmental Approvals / Permits	\$0	\$0	\$0	\$0	\$0	\$0	\$0	\$0	\$0
3. Outreach	\$0	\$0	\$0	\$0	\$0	\$0	\$0	\$0	\$0
4. Siting Approvals / Permits	\$0	\$0	\$0	\$0	\$0	\$0	\$0	\$0	\$0
5. Engineering / Design	\$0	\$0	\$0	\$0	\$0	\$0	\$0	\$0	\$0
6. Materials (Eversource purchased)	\$0	\$0	\$0	\$95	\$0	\$0	\$0	\$0	\$95
7. Construction (incl mat'l's by contractors)	\$0	\$0	\$0	\$160	\$0	\$0	\$0	\$0	\$160
8. Testing / Commissioning	\$0	\$0	\$0	\$0	\$0	\$0	\$0	\$0	\$0
9. Project Mgmt Team	\$0	\$0	\$0	\$0	\$0	\$0	\$0	\$0	\$0
10. Removals	\$0	\$0	\$0	\$20	\$0	\$0	\$0	\$0	\$20
11. Other	\$0	\$0	\$0	\$0	\$0	\$0	\$0	\$0	\$0
12. Risks	\$0	\$0	\$0	\$0	\$0	\$0	\$0	\$0	\$0
SUBTOTAL DIRECTS W/ RISKS	\$0	\$0	\$0	\$275	\$0	\$0	\$0	\$0	\$275
13. Indirects/Overhead	\$0	\$0	\$0	\$212	\$0	\$0	\$0	\$0	\$212
14. AFUDC	\$0	\$0	\$0	\$8	\$0	\$0	\$0	\$0	\$8
PROJECT TOTAL - BASELINE BUDGET	\$0	\$0	\$0	\$495	\$0	\$0	\$0	\$0	\$495
15. Contingency	\$0	\$0	\$0	\$0	\$0	\$0	\$0	\$0	\$0
TOTAL CAPITAL REQUEST	\$0	\$0	\$0	\$495	\$0	\$0	\$0	\$0	\$495
16. Reimbursables/Customer Contribution	\$0	\$0	\$0	\$0	\$0	\$0	\$0	\$0	\$0
PROJECT TOTAL (LESS REIMBURSABLES)	\$0	\$0	\$0	\$495	\$0	\$0	\$0	\$0	\$495
O&M	\$0	\$0	\$0	\$0	\$0	\$0	\$0	\$0	\$0
TOTAL REQUEST	\$0	\$0	\$0	\$495	\$0	\$0	\$0	\$0	\$495

Note: Explain unique payment provisions, if applicable: *Provide a detailed breakdown of Other costs here.*



Breakout Costs

Note: Dollar values are in thousands

Line item Category	Prior Authorized	Actuals to Date	2020 to Go	2021	2022	2023	2024	2025	Total
ST Labor	\$0	\$0	\$0	\$40	\$0	\$0	\$0	\$0	\$40
OT Labor	\$0	\$0	\$0	\$0	\$0	\$0	\$0	\$0	\$0
Outside Services Labor	\$0	\$0	\$0	\$120	\$0	\$0	\$0	\$0	\$120
Materials*	\$0	\$0	\$0	\$95	\$0	\$0	\$0	\$0	\$95
Removals	\$0	\$0	\$0	\$20	\$0	\$0	\$0	\$0	\$20
Other	\$0	\$0	\$0	\$0	\$0	\$0	\$0	\$0	\$0
Indirects	\$0	\$0	\$0	\$212	\$0	\$0	\$0	\$0	\$212
AFUDC	\$0	\$0	\$0	\$8	\$0	\$0	\$0	\$0	\$8
TOTAL CAPITAL REQUEST - W/O REIMBURSABLES	\$0	\$0	\$0	\$495	\$0	\$0	\$0	\$0	\$495

*All materials including Eversource purchased and outside service purchased. Note that outside service purchased material included in construction in project cost summary above.



Future Financial Impacts:

Provide below the estimated future costs that will result from the project:

Note: Dollar values are in thousands

Future Costs	Year 20__	Year 20__	Year 20__	Year 20__ +	Total Future Project Costs
Capital	\$ -	\$ -	\$ -	\$ -	\$ -
O&M	-	-	-	-	-
Other	-	-	-	-	-
TOTAL	\$ -	\$ -	\$ -	\$ -	\$ -

Describe the estimated future Capital, O&M, and/or Other costs noted above:

What functional area(s) will these future costs be funded in? _____
A representative from the respective functional area is required to be included as a project approver.

Provide below the estimated future financial benefits that will result from the project:

Note: Dollar values are in thousands

Future Benefits	Year 20__	Year 20__	Year 20__	Year 20__ +	Total Future Project Benefits
Capital	\$ -	\$ -	\$ -	\$ -	\$ -
O&M	-	-	-	-	-
Other	-	-	-	-	-
TOTAL	\$ -	\$ -	\$ -	\$ -	\$ -

Describe the estimated future Capital, O&M, and/or Other benefits noted above:

What functional area(s) will these benefits be reflected in? _____
A representative from the respective functional area is required to be included as a project approver.

Asset Retirement Obligation (ARO) and/ or Environmental Cleanup Costs (Environmental Liabilities):

Is there an ARO associated with this project? **No**

Are there other environmental cleanup costs associated with this project? **No**



Technical Justification

Project Need Statement

The 3191X3 and the 3112X4 are both radially fed circuits. The project converts part of the 4.16kV section of the 3112X4 to 34.5kV in order to allow for a tie between the 3191X3 and the 3112 mainline. This tie would allow for a backup for 1600 customers that are radially fed.

Project Objectives

This project creates a mainline tie for 1600 radially fed customers. This will allow for automated switching and back feeding during contingencies.

Project Scope

Convert a 4.16kV section of the 3112X4 to 34.5kV in order to create a tie between the 3191X3 and the mainline of the 3191. Reconductor 1700 feet of 1/0 Spacer Cable and change 9 overhead transformers from 4.16kV to 34.5kV. This would allow for switching around faults on the 3191X3 and picking up customers while work is being done. Install a new recloser for a new tap off the 3191 mainline and another recloser on Winnicut Rd for sectionalizing.

Background / Justification

The 3191X3 is a radially fed circuit that feeds 1564 customers. All 1564 customers are at risk of being out for the duration of an outage with no possible ways to back feed customers. This tie would allow for a backup for the 1564 customers on the 3191X3 along with the 36 customers on the 3112X4 that would be converted and moved onto the 3191X3. Outages on the 3191X3 and 3112X4 would have a backup if anything happened. The mainlines of the 3191 and 3112 in these areas run through swampy areas and tend to have long restoration times.

Business Process and / or Technical Improvements

This conversion will eliminate a radial feed circuit by creating a circuit tie. It will replace #2 CU conductor with 1/0 spacer cable, hardening that section of the circuit. This project will also add two new distribution automation devices to allow for automated switching during contingencies.

Alternatives Considered with Cost Estimates

The alternate consideration would be to convert the 3112X4 all the way back to the tap on Breakfast Hill Rd. This would create a tie for the 1564 customers on the 3191X3 and the 149 customers on the 3112X4. This project would add an additional 3000 feet of 1/0 spacer cable, 25 overhead transformers, 2 pad transformers and 1 single phase step-down transformer. The total cost of this project would be \$912,500.

Project Schedule

Milestone/Phase Name	Estimated Date
Engineering & Design Completion	6/1/21
Construction Start	8/1/21
In Service Date	10/1/21

Regulatory Approvals

None

Risks and Risk Mitigation Plans

Cost could escalate due to bids or inaccurate estimate assumptions. If the project is bid and the bids are higher than anticipated, additional funding will be sought.

REDACTED

EVERSOURCE
Project Authorization Form

Greenland is CCI's pole maintenance area which could impact scheduling or project costs if CCI declines to set poles. Operations will need to work closely with CCI to ensure the project is completed in a timely manner. If costs increase due to pole setting, supplemental funding will be sought.

Tree trimming is an unknown cost currently. When the project is sent out to bid and the pole set question has been answered the associated trimming costs could increase the project cost.

Contingency

None

References

None

Attachments (One-Line Diagrams, Images, etc.)

3191 – 3191X3 Tie Map:





Alternate Option Map:

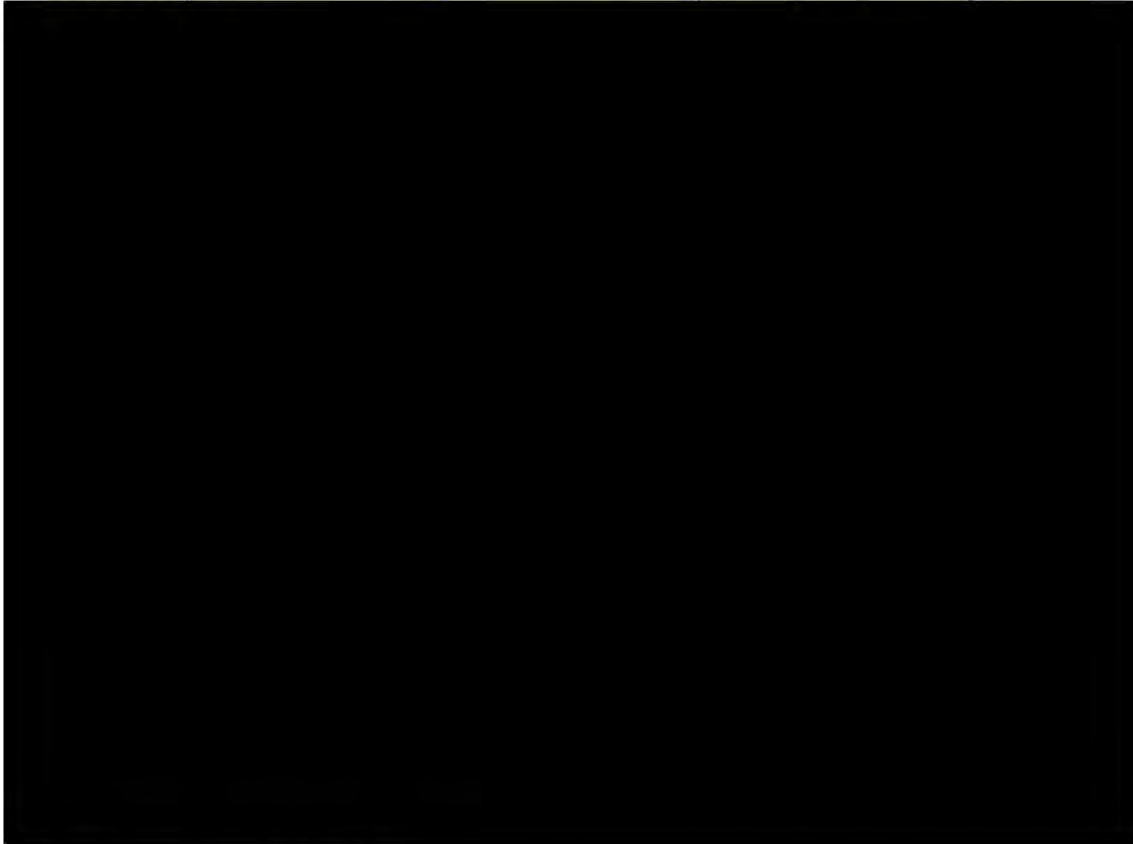

Cost Estimate Backup Details

Job has been written in Maximo, but estimate function is currently not available. Current estimate based on similar cost associated with work completed on other projects.



Operations Project Authorization Form

Date Prepared: 01/21/2021	Project Title: 63W1 Reconductor Drake Hill Rd
Company: Eversource NH	Project Number: A21E21
Organization: Distribution Engineering	Class(es) of Plant: D Line
Project Initiator: Paul Bednarz	Project Category: Lines - Conductor
Project Manager: Michael Busby	Project Type: Specific
Project Sponsor: Russell Johnson	Project Purpose: Relieve overloaded conductor
Estimated in service date: 6/1/2021	Capital Investment part of original Oper. Plan: Yes
Eng./Constr. Resources Budgeted? Yes	O&M Expenses part of original Oper. Plan: Yes
Authorization Type: Full Funding	Facility Type (check all that apply):
Total Request: \$1,062,000	<input type="checkbox"/> PTF <input type="checkbox"/> non-PTF <input checked="" type="checkbox"/> Distribution

Executive Summary

This project authorization form is requesting \$1,062,376 to replace approximately 5,600 feet of two-phase primary conductor with three-phase 477 spacer on Drake Hill Rd in Strafford, NH. The 63W1 circuit out of East Northwood S/S experiences voltage issues during summer peak periods. One of the two phases on Drake Hill Rd is overloaded. Adding a third phase down Drake Hill Rd will improve the circuit balancing, it will eliminate the primary overload, and resolves the voltage issues in the area.

Project Costs Summary *Note: Dollar values are in thousands*

Line item Category	Prior Authorized	Actuals to Date	2020 to Go	2021	2022	2023	2024	2025	Total
1. ROW / Easements / Land Acquisition	\$0	\$0	\$0	\$0	\$0	\$0	\$0	\$0	\$0
2. Environmental Approvals / Permits	\$0	\$0	\$0	\$0	\$0	\$0	\$0	\$0	\$0
3. Outreach	\$0	\$0	\$0	\$0	\$0	\$0	\$0	\$0	\$0
4. Siting Approvals / Permits	\$0	\$0	\$0	\$0	\$0	\$0	\$0	\$0	\$0
5. Engineering / Design	\$0	\$0	\$0	\$85	\$0	\$0	\$0	\$0	\$85
6. Materials (Eversource purchased)	\$0	\$0	\$0	\$203	\$0	\$0	\$0	\$0	\$203
7. Construction (incl matl's by contractors)	\$0	\$0	\$0	\$254	\$0	\$0	\$0	\$0	\$254
8. Testing / Commissioning	\$0	\$0	\$0	\$0	\$0	\$0	\$0	\$0	\$0
9. Project Mgmt Team	\$0	\$0	\$0	\$0	\$0	\$0	\$0	\$0	\$0
10. Removals	\$0	\$0	\$0	\$43	\$0	\$0	\$0	\$0	\$43
11. Other	\$0	\$0	\$0	\$0	\$0	\$0	\$0	\$0	\$0
12. Risks	\$0	\$0	\$0	\$0	\$0	\$0	\$0	\$0	\$0
SUBTOTAL DIRECTS W/ RISKS	\$0	\$0	\$0	\$585	\$0	\$0	\$0	\$0	\$585
13. Indirects/Overhead	\$0	\$0	\$0	\$451	\$0	\$0	\$0	\$0	\$451
14. AFUDC	\$0	\$0	\$0	\$26	\$0	\$0	\$0	\$0	\$26
PROJECT TOTAL - BASELINE BUDGET	\$0	\$0	\$0	\$1,062	\$0	\$0	\$0	\$0	\$1,062
15. Contingency	\$0	\$0	\$0	\$0	\$0	\$0	\$0	\$0	\$0
TOTAL CAPITAL REQUEST	\$0	\$0	\$0	\$1,062	\$0	\$0	\$0	\$0	\$1,062
16. Reimbursables/Customer Contribution	\$0	\$0	\$0	\$0	\$0	\$0	\$0	\$0	\$0
PROJECT TOTAL (LESS REIMBURSABLES)	\$0	\$0	\$0	\$1,062	\$0	\$0	\$0	\$0	\$1,062
O&M	\$0	\$0	\$0	\$0	\$0	\$0	\$0	\$0	\$0
TOTAL REQUEST	\$0	\$0	\$0	\$1,062	\$0	\$0	\$0	\$0	\$1,062

Note: Explain unique payment provisions, if applicable: *Provide a detailed breakdown of Other costs here.*



Breakout Costs

Note: Dollar values are in thousands

Line item Category	Prior Authorized	Actuals to Date	2020 to Go	2021	2022	2023	2024	2025	Total
ST Labor	\$0	\$0	\$0	\$85	\$0	\$0	\$0	\$0	\$85
OT Labor	\$0	\$0	\$0	\$0	\$0	\$0	\$0	\$0	\$0
Outside Services Labor	\$0	\$0	\$0	\$254	\$0	\$0	\$0	\$0	\$254
Materials*	\$0	\$0	\$0	\$203	\$0	\$0	\$0	\$0	\$203
Removals	\$0	\$0	\$0	\$43	\$0	\$0	\$0	\$0	\$43
Other	\$0	\$0	\$0	\$0	\$0	\$0	\$0	\$0	\$0
Indirects	\$0	\$0	\$0	\$451	\$0	\$0	\$0	\$0	\$451
AFUDC	\$0	\$0	\$0	\$26	\$0	\$0	\$0	\$0	\$26
TOTAL CAPITAL REQUEST - W/O REIMBURSABLES	\$0	\$0	\$0	\$1,062	\$0	\$0	\$0	\$0	\$1,062

*All materials including Eversource purchased and outside service purchased. Note that outside service purchased material included in construction in project cost summary above.



Future Financial Impacts:

Provide below the estimated future costs that will result from the project:

Note: Dollar values are in thousands

Future Costs	Year 20__	Year 20__	Year 20__	Year 20__ +	Total Future Project Costs
Capital	\$ -	\$ -	\$ -	\$ -	\$ -
O&M	-	-	-	-	-
Other	-	-	-	-	-
TOTAL	\$ -	\$ -	\$ -	\$ -	\$ -

Describe the estimated future Capital, O&M, and/or Other costs noted above:

What functional area(s) will these future costs be funded in? _____

A representative from the respective functional area is required to be included as a project approver.

Provide below the estimated future financial benefits that will result from the project:

Note: Dollar values are in thousands

Future Benefits	Year 20__	Year 20__	Year 20__	Year 20__ +	Total Future Project Benefits
Capital	\$ -	\$ -	\$ -	\$ -	\$ -
O&M	-	-	-	-	-
Other	-	-	-	-	-
TOTAL	\$ -	\$ -	\$ -	\$ -	\$ -

Describe the estimated future Capital, O&M, and/or Other benefits noted above:

What functional area(s) will these benefits be reflected in? _____

A representative from the respective functional area is required to be included as a project approver.

Asset Retirement Obligation (ARO) and/ or Environmental Cleanup Costs (Environmental Liabilities):

Is there an ARO associated with this project? **No.**

Are there other environmental cleanup costs associated with this project? **No.**



Technical Justification

Project Need Statement

During the 2020 summer peak period, the 63W1 received numerous voltage complaints in the Bow Lake Area. The low voltage was validated via field measurements and the DistriView model. Pole mounted regulators located on Drake Hill Rd and Roller Coaster Dr have historically peaked at maximum range of raise 16. In addition, the 1/0 ACSR conductor from East Northwood S/S to Province Hill Rd is overloaded. Per DSEM 08.101, the normal summer rating for 1/0 ACSR is 250 amps. Peak loading based on line sensor data at P820/12, reached 278 amps. By reconductoring, adding a third phase, and balancing the load, it will improve voltage and resolve loading issues in the Bow Lake area.

Project Objectives

Extending the third phase by reconductoring from Drake Hill Rd to the Bow Lake area and balance the circuit to improve voltage, reduce the loading on A and B phase, and resolve current protection issues.

Project Scope

Install 1.06 miles of 477 Spacer cable along Drake Hill Rd in Strafford.
Install 1-167 kVA, 219A, 7.2 kV Regulator and associated equipment at P820/90 on new phase.
Install 1-900 kVAR Capacitor bank and associated equipment at P820/109

Background / Justification

East Northwood 63W1 is a three-phase circuit extending down Strafford Rd, transitioning to two phases on Drake Hill Rd, feeding the Bow Lake area (1,126 customers). Due to the conductor size and ampacity on two of the three phases, this circuit experiences voltage issues during peak demand. The ampacity on B phase during peak demand is greater than the normal conductor ampacity rating. Further balancing is not possible due to long radial single-phase taps. The regulators located on Drake Hill Rd and Roller Coaster Rd have historically reached maximum raise of +16. Extending the third phase helps balance the circuit, offloads overloaded conductor, and resolves customer voltage issues.

In 2020, the East Northwood offload project was completed; although, this project benefitted the station transformer by reducing the load, it did not resolve overloaded conductor or low voltage issues in the Bow Lake Area. Recently, the three 200 amp hydraulic reclosers near the station on Rochester Rd have been replaced with a Nova. Due to the high load current and low fault duty, P&C Engineering could not develop settings which meet sensitivity margins. Reconductoring will reduce phase loading and increase fault duty, so P&C will be able to reconfigure settings to meet sensitivity margins.

Business Process and / or Technical Improvements

Extending the third phase to Bow Lake area from Drake Hill Rd will improve the circuit balancing, it will eliminate overloaded conductor, and resolves the voltage issues in the area. Installing spacer cable will also help circuit hardening on that section of the circuit.

Alternatives Considered with Cost Estimates

Convert the circuit to 34.5 kV and install step down transformers for side taps. This alternative was not fully investigated due to the magnitude of cost increase and reliability issues.

Another alternative considered was to install a 12 kV substation in the Rochester AWC to offload East Northwood. This option is far more costly and cannot resolve voltage issues by 2021 summer peak period.

Field Engineering will request planning engineering to perform a long-term study to address load growth in the East Northwood/Strafford/Barrington area.



Project Schedule

Milestone/Phase Name	Estimated Date
100% Engineering Completion	Complete
Construction Start	4/1/2021
In Service Date	6/1/2021

Regulatory Approvals

None

Risks and Risk Mitigation Plans

Cost could escalate due to bids or inaccurate estimate assumptions. If the project is bid and the bids are higher than anticipated, additional funding will be sought.

Strafford is CCI's pole maintenance area which could impact scheduling or project costs if CCI declines to set poles. Operations will need to work closely with CCI to ensure the project is completed in a timely manner. If costs increase due to pole setting, supplemental funding will be sought.

Tree trimming is an unknown cost currently. When the project is sent out to bid and the pole set question has been answered the associated trimming costs could increase the project cost.

Contingency

None

References

None



Attachments (One-Line Diagrams, Images, etc.)

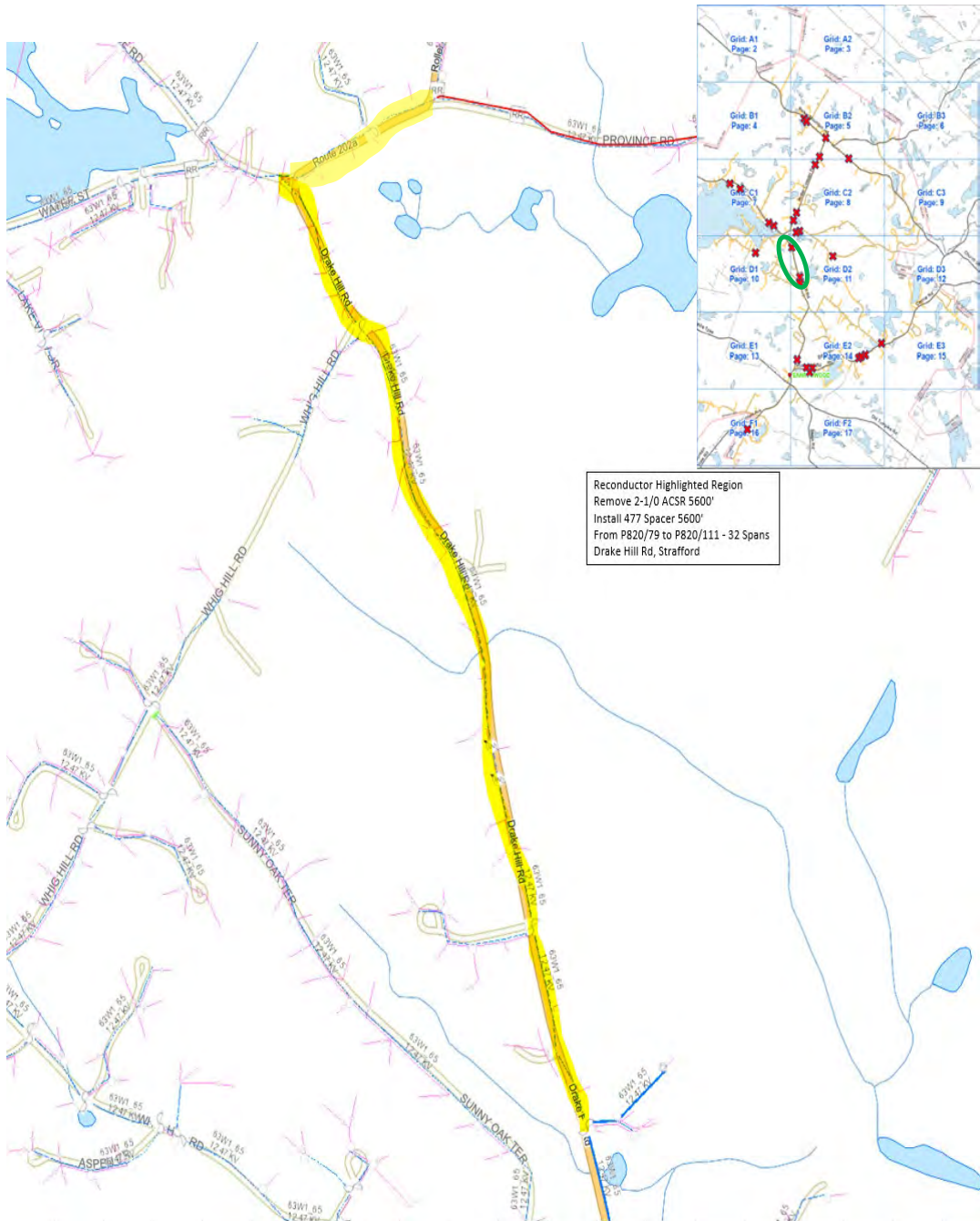

Cost Estimate Backup Details

Engineering cost estimate based on \$160 per foot to install 477 SPCA.



Operations Project Authorization Form

Date Prepared: 12/01/2020	Project Title: 3191X1A Piscassic Rd Conversion
Company: Eversource NH	Project Number: A21E22
Organization: Distribution Engineering	Class(es) of Plant: D Line
Project Initiator: Paul Bednarz	Project Category: Lines - General
Project Manager: Michael Busby	Project Type: Specific
Project Sponsor: Russell Johnson	Project Purpose: Offload overloaded steps and conductor
Estimated in service date: 6/1/2021	Capital Investment part of original Oper. Plan: Yes
Eng./Constr. Resources Budgeted? Yes	O&M Expenses part of original Oper. Plan: Yes
Authorization Type: Full Funding	Facility Type (check all that apply):
Total Request: \$778,000	<input type="checkbox"/> PTF <input type="checkbox"/> non-PTF <input checked="" type="checkbox"/> Distribution

Executive Summary

This project authorization form is requesting \$778,000 to offload three overloaded steps by converting 35 sections of Piscassic Rd and Old Lee Rd in Newfields, NH. This project will reconductor 10 spans of overloaded primary conductor on Piscassic Rd, and 16 spans of overloaded damaged primary conductor on Old Lee Rd. This project will remove overloaded steps and overloaded primary conductor improving the voltage in the area.



Project Costs Summary *Note: Dollar values are in thousands*

Line item Category	Prior Authorized	Actuals to Date	2020 to Go	2021	2022	2023	2024	2025	Total
1. ROW/ Easements / Land Acquisition	\$0	\$0	\$0	\$0	\$0	\$0	\$0	\$0	\$0
2. Environmental Approvals / Permits	\$0	\$0	\$0	\$0	\$0	\$0	\$0	\$0	\$0
3. Outreach	\$0	\$0	\$0	\$0	\$0	\$0	\$0	\$0	\$0
4. Siting Approvals / Permits	\$0	\$0	\$0	\$0	\$0	\$0	\$0	\$0	\$0
5. Engineering / Design	\$0	\$0	\$0	\$0	\$0	\$0	\$0	\$0	\$0
6. Materials (Eversource purchased)	\$0	\$0	\$0	\$148	\$0	\$0	\$0	\$0	\$148
7. Construction (incl mat'l's by contractors)	\$0	\$0	\$0	\$250	\$0	\$0	\$0	\$0	\$250
8. Testing / Commissioning	\$0	\$0	\$0	\$0	\$0	\$0	\$0	\$0	\$0
9. Project Mgmt Team	\$0	\$0	\$0	\$0	\$0	\$0	\$0	\$0	\$0
10. Removals	\$0	\$0	\$0	\$32	\$0	\$0	\$0	\$0	\$32
11. Other	\$0	\$0	\$0	\$0	\$0	\$0	\$0	\$0	\$0
12. Risks	\$0	\$0	\$0	\$0	\$0	\$0	\$0	\$0	\$0
SUBTOTAL DIRECTS W/ RISKS	\$0	\$0	\$0	\$430	\$0	\$0	\$0	\$0	\$430
13. Indirects/Overhead	\$0	\$0	\$0	\$332	\$0	\$0	\$0	\$0	\$332
14. AFUDC	\$0	\$0	\$0	\$16	\$0	\$0	\$0	\$0	\$16
PROJECT TOTAL – BASELINE BUDGET	\$0	\$0	\$0	\$778	\$0	\$0	\$0	\$0	\$778
15. Contingency	\$0	\$0	\$0	\$0	\$0	\$0	\$0	\$0	\$0
TOTAL CAPITAL REQUEST	\$0	\$0	\$0	\$778	\$0	\$0	\$0	\$0	\$778
16. Reimbursables/Customer Contribution	\$0	\$0	\$0	\$0	\$0	\$0	\$0	\$0	\$0
PROJECT TOTAL (LESS REIMBURSABLES)	\$0	\$0	\$0	\$778	\$0	\$0	\$0	\$0	\$778
O&M	\$0	\$0	\$0	\$0	\$0	\$0	\$0	\$0	\$0
TOTAL REQUEST	\$0	\$0	\$0	\$778	\$0	\$0	\$0	\$0	\$778

Note: Explain unique payment provisions, if applicable: *Provide a detailed breakdown of Other costs here.*



Breakout Costs

Note: Dollar values are in thousands

Line item Category	Prior Authorized	Actuals to Date	2020 to Go	2021	2022	2023	2024	2025	Total
ST Labor	\$0	\$0	\$0	\$62	\$0	\$0	\$0	\$0	\$62
OT Labor	\$0	\$0	\$0	\$0	\$0	\$0	\$0	\$0	\$0
Outside Services Labor	\$0	\$0	\$0	\$188	\$0	\$0	\$0	\$0	\$188
Materials*	\$0	\$0	\$0	\$148	\$0	\$0	\$0	\$0	\$148
Removals	\$0	\$0	\$0	\$32	\$0	\$0	\$0	\$0	\$32
Other	\$0	\$0	\$0	\$0	\$0	\$0	\$0	\$0	\$0
Indirects	\$0	\$0	\$0	\$332	\$0	\$0	\$0	\$0	\$332
AFUDC	\$0	\$0	\$0	\$16	\$0	\$0	\$0	\$0	\$16
TOTAL CAPITAL REQUEST - W/O REIMBURSABLES	\$0	\$0	\$0	\$778	\$0	\$0	\$0	\$0	\$778

*All materials including Eversource purchased and outside service purchased. Note that outside service purchased material included in construction in project cost summary above.



Future Financial Impacts:

Provide below the estimated future costs that will result from the project:

Note: Dollar values are in thousands

Future Costs	Year 20__	Year 20__	Year 20__	Year 20__ +	Total Future Project Costs
Capital	\$ -	\$ -	\$ -	\$ -	\$ -
O&M	-	-	-	-	-
Other	-	-	-	-	-
TOTAL \$	\$ -	\$ -	\$ -	\$ -	\$ -

Describe the estimated future Capital, O&M, and/or Other costs noted above:

What functional area(s) will these future costs be funded in? _____

A representative from the respective functional area is required to be included as a project approver.

Provide below the estimated future financial benefits that will result from the project:

Note: Dollar values are in thousands

Future Benefits	Year 20__	Year 20__	Year 20__	Year 20__ +	Total Future Project Benefits
Capital	\$ -	\$ -	\$ -	\$ -	\$ -
O&M	-	-	-	-	-
Other	-	-	-	-	-
TOTAL \$	\$ -	\$ -	\$ -	\$ -	\$ -

Describe the estimated future Capital, O&M, and/or Other benefits noted above:

What functional area(s) will these benefits be reflected in? _____

A representative from the respective functional area is required to be included as a project approver.

Asset Retirement Obligation (ARO) and/ or Environmental Cleanup Costs (Environmental Liabilities):

Is there an ARO associated with this project? **No**

Are there other environmental cleanup costs associated with this project? **No**



Technical Justification

Project Need Statement

The need for this project is to offload overloaded steps, reconductor damaged and overloaded primary conductor, and to remove step up transformers from the distribution system.

Project Objectives

The objective of this project is to off-load overloaded 3-333 kVA steps on Piscassic Rd in Newfields by converting a portion of the circuit to 19.9kV, and to reconductor overloaded primary conductor.

Project Scope

The conversion will complete the following:

- Convert 26 transformers – 2.4kV to 19.9 kV
- Install 3-500 kVA 19.9/2.4 kV Step-downs. Remove 3-333 kVA step down transformers
- Remove 4-2.4kV/19.9kV Step up transformers.
- Reconductor 10 spans of 3-#4 CU conductor with 3-477 SPCA from P2/4 to P2/14 (1214')
- Reconductor 16 spans of 1-#2 ACSR conductor with 1-1/0 AL TW from P14/1 to P14/9 (2815')

Background / Justification

The 3191X1A is a radial tap off the 3229-line feeding 659 customers in Newfields. During the heat wave of 07/19/2020, a span of #4 ACSR conductor burned down between P14/5 and P14/6 on Old Lee Rd due to load and cable condition. A field inspection revealed about 30 splices on Old Lee Rd. Also, the upline 3-333 kVA steps on Piscassic Rd, Newfields, are overloaded. Based on the thermal ammeter readings, the steps are loaded at 441 kVA (132%), 451 kVA (135%), and 537 kVA (161%). Downline from the step, there is 1,214' of #4 Cu primary conductor exceeding ampacity rating (185 amps) during summer peak demand. The three-phase conductor on Piscassic Rd is 477 ACSR or 336 ACSR except for these ten spans of overloaded copper conductor. Old Lee Rd has 2,821' of #2 ACSR primary conductor exceeding ampacity rating (190 amps). Also, there are 2.4/19.9 kV step-up transformers feeding looped URD's without a back feed. Regulator history on Old Lee Rd shows the drag hand at +16R some years indicating low voltage during peak demand.

Business Process and / or Technical Improvements

This project will alleviate overloaded step transformer improving voltage, reconductor ten spans of overloaded 3- #4 CU conductor, reconductor sixteen spans of 1- # 2 ACSR conductor, remove step-up transformers feeding URDs, and improve voltage by removing overloaded steps and primary conductor.

Alternatives Considered with Cost Estimates

An alternative considered was to reconductor up to P2/54 to remove additional step up transformers from the system and to convert more of the 2.4 kV circuit. To reduce project costs, it was determined the best solution was to convert only the three phase on Piscassic Rd.

Another alternative considered was to install parallel steps instead of converting Piscassic Rd. The copper conductor on Piscassic Rd would still need to be reconducted due to overload, and the #2 ACSR on Old Lee Rd would need to be converted due to condition and overload.

Project Schedule

Milestone/Phase Name	Estimated Date
Engineering & Design Completion	3/15/2021
Construction Start	4/15/2021
In Service Date	6/15/2021

Regulatory Approvals

None



Risks and Risk Mitigation Plans

Cost could escalate due to bids or inaccurate estimate assumptions. If the project is bid and the bids are higher than anticipated, additional funding will be sought.

Newfields is CCI's pole maintenance area which could impact scheduling or project costs if CCI declines to set poles. Operations will need to work closely with CCI to ensure the project is completed in a timely manner. If costs increase due to pole setting, supplemental funding will be sought.

Tree trimming is an unknown cost currently. When the project is sent out to bid and the pole set question has been answered the associated trimming costs could increase the project cost.

Contingency

None

References

None

Attachments (One-Line Diagrams, Images, etc.)



Cost Estimate Backup Details

Current estimate based on similar cost associated with work completed on other projects. Estimating function in Maximo is currently unavailable.



Operations Project Authorization Form

Date Prepared: 12/10/2020	Project Title: Fogg Rd Conversion
Company: Eversource NH	Project Number: A21E23
Organization: Distribution Engineering	Class(es) of Plant: D Line
Project Initiator: Paul Bednarz	Project Category: Lines - General
Project Manager: Michael Busby	Project Type: Specific
Project Sponsor: Russell Johnson	Project Purpose: Offload overloaded step down
Estimated in service date: 6/1/2021	Capital Investment part of original Oper. Plan: Yes
Eng./Constr. Resources Budgeted? Yes	O&M Expenses part of original Oper. Plan: Yes
Authorization Type: Full Funding	Facility Type (check all that apply):
Total Request: \$ 543,000	<input type="checkbox"/> PTF <input type="checkbox"/> non-PTF <input checked="" type="checkbox"/> Distribution

Executive Summary

This project authorization form is requesting \$543,000 to convert 14 sections on Fogg Rd in Epping, NH and reconductor 16 sections on Coffin Rd to remove an overloaded step transformer on the 377X3. In addition, this project provides additional capacity for a new 100 home development being built on Fogg Rd next year. This project eliminates an overloaded 500 kVA stepdown transformer by converting Fogg Rd and hanging new parallel stepdown transformers beyond the proposed 100 home development.



Project Costs Summary *Note: Dollar values are in thousands*

Line item Category	Prior Authorized	Actuals to Date	2020 to Go	2021	2022	2023	2024	2025	Total
1. ROW/ Easements / Land Acquisition	\$0	\$0	\$0	\$0	\$0	\$0	\$0	\$0	\$0
2. Environmental Approvals / Permits	\$0	\$0	\$0	\$0	\$0	\$0	\$0	\$0	\$0
3. Outreach	\$0	\$0	\$0	\$0	\$0	\$0	\$0	\$0	\$0
4. Siting Approvals / Permits	\$0	\$0	\$0	\$0	\$0	\$0	\$0	\$0	\$0
5. Engineering / Design	\$0	\$0	\$0	\$0	\$0	\$0	\$0	\$0	\$0
6. Materials (Eversource purchased)	\$0	\$0	\$0	\$103	\$0	\$0	\$0	\$0	\$103
7. Construction (incl mat'l's by contractors)	\$0	\$0	\$0	\$173	\$0	\$0	\$0	\$0	\$173
8. Testing / Commissioning	\$0	\$0	\$0	\$0	\$0	\$0	\$0	\$0	\$0
9. Project Mgmt Team	\$0	\$0	\$0	\$0	\$0	\$0	\$0	\$0	\$0
10. Removals	\$0	\$0	\$0	\$23	\$0	\$0	\$0	\$0	\$23
11. Other	\$0	\$0	\$0	\$0	\$0	\$0	\$0	\$0	\$0
12. Risks	\$0	\$0	\$0	\$0	\$0	\$0	\$0	\$0	\$0
SUBTOTAL DIRECTS W/ RISKS	\$0	\$0	\$0	\$299	\$0	\$0	\$0	\$0	\$299
13. Indirects/Overhead	\$0	\$0	\$0	\$232	\$0	\$0	\$0	\$0	\$232
14. AFUDC	\$0	\$0	\$0	\$12	\$0	\$0	\$0	\$0	\$12
PROJECT TOTAL – BASELINE BUDGET	\$0	\$0	\$0	\$543	\$0	\$0	\$0	\$0	\$543
15. Contingency	\$0	\$0	\$0	\$0	\$0	\$0	\$0	\$0	\$0
TOTAL CAPITAL REQUEST	\$0	\$0	\$0	\$543	\$0	\$0	\$0	\$0	\$543
16. Reimbursables/Customer Contribution	\$0	\$0	\$0	\$0	\$0	\$0	\$0	\$0	\$0
PROJECT TOTAL (LESS REIMBURSABLES)	\$0	\$0	\$0	\$543	\$0	\$0	\$0	\$0	\$543
O&M	\$0	\$0	\$0	\$0	\$0	\$0	\$0	\$0	\$0
TOTAL REQUEST	\$0	\$0	\$0	\$543	\$0	\$0	\$0	\$0	\$543

Note: Explain unique payment provisions, if applicable: *Provide a detailed breakdown of Other costs here.*



Breakout Costs

Note: Dollar values are in thousands

Line item Category	Prior Authorized	Actuals to Date	2020 to Go	2021	2022	2023	2024	2025	Total
ST Labor	\$0	\$0	\$0	\$43	\$0	\$0	\$0	\$0	\$43
OT Labor	\$0	\$0	\$0	\$0	\$0	\$0	\$0	\$0	\$0
Outside Services Labor	\$0	\$0	\$0	\$130	\$0	\$0	\$0	\$0	\$130
Materials*	\$0	\$0	\$0	\$103	\$0	\$0	\$0	\$0	\$103
Removals	\$0	\$0	\$0	\$23	\$0	\$0	\$0	\$0	\$23
Other	\$0	\$0	\$0	\$0	\$0	\$0	\$0	\$0	\$0
Indirects	\$0	\$0	\$0	\$232	\$0	\$0	\$0	\$0	\$232
AFUDC	\$0	\$0	\$0	\$12	\$0	\$0	\$0	\$0	\$12
TOTAL CAPITAL REQUEST - W/O REIMBURSABLES	\$0	\$0	\$0	\$543	\$0	\$0	\$0	\$0	\$543

*All materials including Eversource purchased and outside service purchased. Note that outside service purchased material included in construction in project cost summary above.



Future Financial Impacts:

Provide below the estimated future costs that will result from the project:

Note: Dollar values are in thousands

Future Costs	Year 20__	Year 20__	Year 20__	Year 20__ +	Total Future Project Costs
Capital	\$ -	\$ -	\$ -	\$ -	\$ -
O&M	-	-	-	-	-
Other	-	-	-	-	-
TOTAL \$	-	-	-	-	-

Describe the estimated future Capital, O&M, and/or Other costs noted above:

What functional area(s) will these future costs be funded in? _____

A representative from the respective functional area is required to be included as a project approver.

Provide below the estimated future financial benefits that will result from the project:

Note: Dollar values are in thousands

Future Benefits	Year 20__	Year 20__	Year 20__	Year 20__ +	Total Future Project Benefits
Capital	\$ -	\$ -	\$ -	\$ -	\$ -
O&M	-	-	-	-	-
Other	-	-	-	-	-
TOTAL \$	-	-	-	-	-

Describe the estimated future Capital, O&M, and/or Other benefits noted above:

What functional area(s) will these benefits be reflected in? _____

A representative from the respective functional area is required to be included as a project approver.

Asset Retirement Obligation (ARO) and/ or Environmental Cleanup Costs (Environmental Liabilities):

Is there an ARO associated with this project? If yes, please provide details: **No**

Are there other environmental cleanup costs associated with this project? **No**



Technical Justification

Project Need Statement

During the 2020 Summer peak period, the 500-kVA stepdown transformer on the 377X3, P291/8, Fogg Rd, Epping was loaded at 672 kVA (134% of nameplate capacity). A new underground residential development is expected to be built sometime next year on Fogg Rd, consisting of 100 single family homes, all with 200A services and small HVAC load. With the addition of the new URD, the step will significantly exceed recommended loading capacity. This project is requesting \$543,000 to convert a portion of the 377X3 including all of Fogg Rd and a portion of Stagecoach Rd. New parallel 500 kVA step-down transformers will be installed on P30/3 on N River Rd, reducing the load on the step to 50% of nameplate capacity. This project extends the 377X3 on Coffin Rd to Calef Hwy by installing 2200' of 477 SPCA at an estimated cost of \$352,000 (\$160 per foot). The new three phase spacer extension will service the new URD and offload a portion of the 377X10 fed from a heavily loaded 500kVA step down (110%).

The 3-500 kVA stepdown transformers on the 377X10, P67A/2, Lagdon Rd, Epping are overloaded per nameplate capacity based on meter reads (110%). Extending three phase spacer has the added benefit of offloading the 377X10 onto the 377X3 and creating a future 19.9 kV circuit tie with the 377X10. This will reduce the loading on the 3-500 kVA steps on the 377X10 to an estimated 90%.

Project Objectives

This project will accomplish the following:

- Relocate an overloaded step transformer and provide capacity to serve a new 100 home URD on Fogg Rd, Epping, NH.
- Reduce loading on heavily loaded steps on the 377X10.
- Create future opportunity for a circuit tie between the 377X3 and the 377X10.

Project Scope

This project will complete the following:

- Conversion of the 377X3 from 4.16 kV to 34.5 kV on Fogg Rd
 - o Install parallel 500 kVA steps on N River Rd
- Reconductor 1-1/0 ACSR on Coffin Rd from P29/31Y to P29/22 with 3-477 Spacer.
 - o Provide capacity to serve new 100 home URD on Fogg Rd, Epping
 - o Create a future circuit tie between the 377X3 and 377X10.
 - o Offloads step on the 377X10.

Background / Justification

The 500kVA step-transformer on Fogg Rd was identified as potentially overloaded based on customer count and connected kVA, prompting a VARCorder to be installed. VARCorder data revealed the step to be loaded at 672 kVA (134% of nameplate capacity). With the addition of a new URD, the step will far-exceed recommended loading capacity. The 377X10 steps are also loaded past nameplate, at 110% of nameplate. This project reconductors the 1-1/0 ACSR on Coffin Rd to 3-477 SPCA to offload a portion of the 377X10, and to create a future circuit tie between the 377X3 and 377X10. This project also converts 14 sections to 19.9 kV on Fogg Rd to alleviate the overloaded stepdown transformer on Fogg Rd.

Business Process and / or Technical Improvements

The technical improvements from this project is that it provides capacity for area load growth by offloading two heavily loaded steps, and it creates a potential future circuit tie between the 377X3 and 377X10.

Alternatives Considered with Cost Estimates

Extend three phases on Coffin Rd (2650', 16 spans), convert Fogg Rd (18 spans to 19.9kV) and N River Rd (30 spans to 19.9kV).

- Converting Fogg Rd, 7 OH transformers: \$28,000



- Converting Old Stagecoach Rd, 2 OH transformers: \$8,000
- Converting N River Rd, 9 OH Transformers: \$36,000
- Converting N River Rd, 10 Pad mount transformers: \$60,000
- Install new 250 kVA stepdown on Old Stage Rd: \$20,000
- Install new 500 kVA step on N River Rd: \$20,000
- Cost of 2600' of 477 Spacer Cable: \$424,000
- Total cost: \$599,000

This alternative converts an additional 25 spans further down N River Rd to P30/25A. This allows us to feed the remaining 4.8 kV load with 1-500 kVA step down.

Project Schedule

Milestone/Phase Name	Estimated Date
Engineering & Design Completion	4/1/2021
Construction Start	5/1/2021
In Service Date	7/1/2021

Regulatory Approvals

None

Risks and Risk Mitigation Plans

Cost could escalate due to bids or inaccurate estimate assumptions. If the project is bid and the bids are higher than anticipated, additional funding will be sought.

Epping is CCI's pole maintenance area which could impact scheduling or project costs if CCI declines to set poles. Operations will need to work closely with CCI to ensure the project is completed in a timely manner. If costs increase due to pole setting, supplemental funding will be sought.

Tree trimming is an unknown cost currently. When the project is sent out to bid and the pole set question has been answered the associated trimming costs could increase the project cost.

Contingency

None

References

None

REDACTED



Attachments (One-Line Diagrams, Images, etc.)

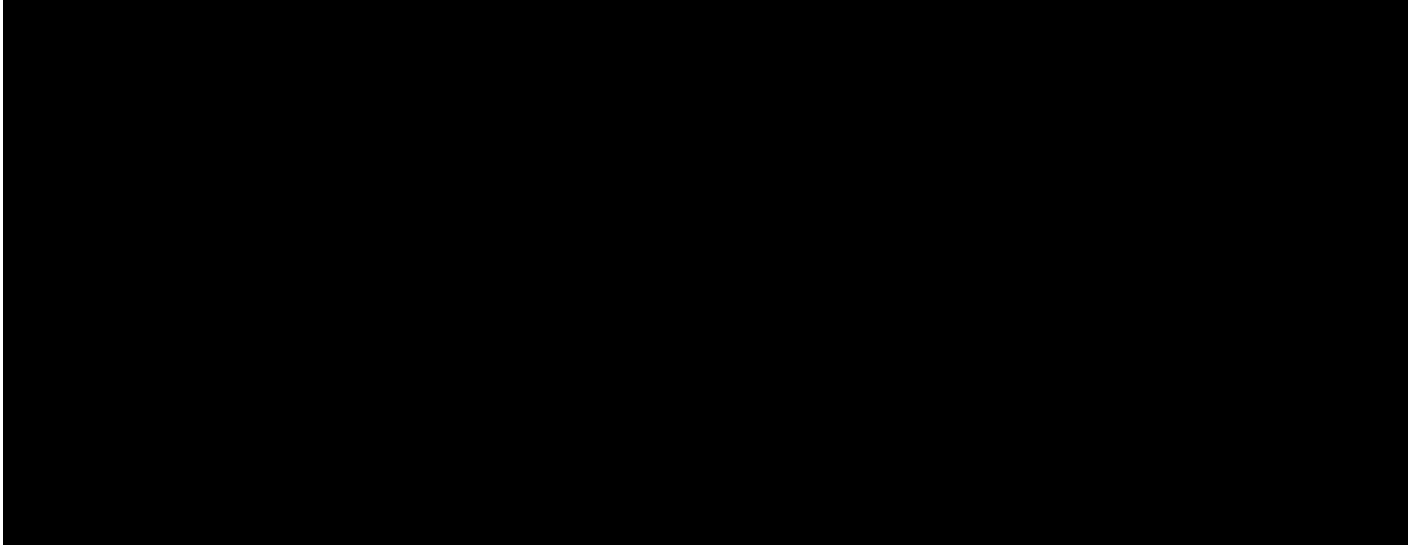



Cost Estimate Backup Details

Current estimate based on similar cost associated with work completed on other projects. Estimating function in Maximo is currently unavailable.



Operations Project Authorization Form

Date Prepared: 01/18/2021	Project Title: Beauty Hill Rd Conversion
Company: Eversource NH	Project Number: A21E24
Organization: Distribution Engineering	Class(es) of Plant: D Line
Project Initiator: Trevor Emmons	Project Category: Lines - General
Project Manager: Michael Busby	Project Type: Specific
Project Sponsor: Russell Johnson	Project Purpose: Relieve Overloaded Step Transformers
Estimated in service date: 06/01/2021	Capital Investment part of original Oper. Plan: Yes
Eng./Constr. Resources Budgeted? Yes	O&M Expenses part of original Oper. Plan: Yes
Authorization Type: Full Funding	Facility Type (check all that apply):
Total Request: \$522,000	<input type="checkbox"/> PTF <input type="checkbox"/> non-PTF <input checked="" type="checkbox"/> Distribution

Executive Summary

This project authorization form is requesting \$522,000 to convert 25 sections of Beauty Hill Rd and 20 sections of Hall Road in Barrington NH to remove overloaded parallel stepdown transformers on the 392X7 circuit out of the Rochester AWC. This project eliminates overloaded parallel 500 kVA stepdown transformers by converting a portion of the area and hanging new stepdown transformers further out on the circuit.



Project Costs Summary *Note: Dollar values are in thousands*

Line item Category	Prior Authorized	Actuals to Date	2020 to Go	2021	2022	2023	2024	2025	Total
1. ROW/ Easements / Land Acquisition	\$0	\$0	\$0	\$0	\$0	\$0	\$0	\$0	\$0
2. Environmental Approvals / Permits	\$0	\$0	\$0	\$0	\$0	\$0	\$0	\$0	\$0
3. Outreach	\$0	\$0	\$0	\$0	\$0	\$0	\$0	\$0	\$0
4. Siting Approvals / Permits	\$0	\$0	\$0	\$0	\$0	\$0	\$0	\$0	\$0
5. Engineering / Design	\$0	\$0	\$0	\$0	\$0	\$0	\$0	\$0	\$0
6. Materials (Eversource purchased)	\$0	\$0	\$0	\$58	\$0	\$0	\$0	\$0	\$58
7. Construction (incl mat'l's by contractors)	\$0	\$0	\$0	\$262	\$0	\$0	\$0	\$0	\$262
8. Testing / Commissioning	\$0	\$0	\$0	\$0	\$0	\$0	\$0	\$0	\$0
9. Project Mgmt Team	\$0	\$0	\$0	\$0	\$0	\$0	\$0	\$0	\$0
10. Removals	\$0	\$0	\$0	\$0	\$0	\$0	\$0	\$0	\$0
11. Other	\$0	\$0	\$0	\$0	\$0	\$0	\$0	\$0	\$0
12. Risks	\$0	\$0	\$0	\$0	\$0	\$0	\$0	\$0	\$0
SUBTOTAL DIRECTS W/ RISKS	\$0	\$0	\$0	\$320	\$0	\$0	\$0	\$0	\$320
13. Indirects/Overhead	\$0	\$0	\$0	\$187	\$0	\$0	\$0	\$0	\$187
14. AFUDC	\$0	\$0	\$0	\$15	\$0	\$0	\$0	\$0	\$15
PROJECT TOTAL – BASELINE BUDGET	\$0	\$0	\$0	\$522	\$0	\$0	\$0	\$0	\$522
15. Contingency	\$0	\$0	\$0	\$0	\$0	\$0	\$0	\$0	\$0
TOTAL CAPITAL REQUEST	\$0	\$0	\$0	\$522	\$0	\$0	\$0	\$0	\$522
16. Reimbursables/Customer Contribution	\$0	\$0	\$0	\$0	\$0	\$0	\$0	\$0	\$0
PROJECT TOTAL (LESS REIMBURSABLES)	\$0	\$0	\$0	\$522	\$0	\$0	\$0	\$0	\$522
O&M	\$0	\$0	\$0	\$0	\$0	\$0	\$0	\$0	\$0
TOTAL REQUEST	\$0	\$0	\$0	\$522	\$0	\$0	\$0	\$0	\$522

Note: Explain unique payment provisions, if applicable: *Provide a detailed breakdown of Other costs here.*



Breakout Costs

Note: Dollar values are in thousands

Line item Category	Prior Authorized	Actuals to Date	2020 to Go	2021	2022	2023	2024	2025	Total
ST Labor	\$0	\$0	\$0	\$0	\$0	\$0	\$0	\$0	\$0
OT Labor	\$0	\$0	\$0	\$0	\$0	\$0	\$0	\$0	\$0
Outside Services Labor	\$0	\$0	\$0	\$262	\$0	\$0	\$0	\$0	\$262
Materials*	\$0	\$0	\$0	\$58	\$0	\$0	\$0	\$0	\$58
Removals	\$0	\$0	\$0	\$0	\$0	\$0	\$0	\$0	\$0
Other	\$0	\$0	\$0	\$0	\$0	\$0	\$0	\$0	\$0
Indirects	\$0	\$0	\$0	\$187	\$0	\$0	\$0	\$0	\$187
AFUDC	\$0	\$0	\$0	\$15	\$0	\$0	\$0	\$0	\$15
TOTAL CAPITAL REQUEST - W/O REIMBURSABLES	\$0	\$0	\$0	\$522	\$0	\$0	\$0	\$0	\$522

*All materials including Eversource purchased and outside service purchased. Note that outside service purchased material included in construction in project cost summary above.



Future Financial Impacts:

Provide below the estimated future costs that will result from the project: **None**

Note: Dollar values are in thousands

Future Costs	Year 20__	Year 20__	Year 20__	Year 20__ +	Total Future Project Costs
Capital	\$ -	\$ -	\$ -	\$ -	\$ -
O&M	-	-	-	-	-
Other	-	-	-	-	-
TOTAL	\$ -	\$ -	\$ -	\$ -	\$ -

Describe the estimated future Capital, O&M, and/or Other costs noted above:

What functional area(s) will these future costs be funded in? _____
A representative from the respective functional area is required to be included as a project approver.

Provide below the estimated future financial benefits that will result from the project:

Note: Dollar values are in thousands

Future Benefits	Year 20__	Year 20__	Year 20__	Year 20__ +	Total Future Project Benefits
Capital	\$ -	\$ -	\$ -	\$ -	\$ -
O&M	-	-	-	-	-
Other	-	-	-	-	-
TOTAL	\$ -	\$ -	\$ -	\$ -	\$ -

Describe the estimated future Capital, O&M, and/or Other benefits noted above:

What functional area(s) will these benefits be reflected in? _____
A representative from the respective functional area is required to be included as a project approver.

Asset Retirement Obligation (ARO) and/ or Environmental Cleanup Costs (Environmental Liabilities):

Is there an ARO associated with this project? **No**

Are there other environmental cleanup costs associated with this project? **No**



Technical Justification

Project Need Statement

The loading on the parallel 500 kVA stepdown transformers on Beauty Hill Road in Barrington reached 1,022 kVA (102%) during the 2020 summer peak based on Aclara line sensor data. For loss of one of the step transformers at peak, the remaining transformer would not be able to carry the load. All of Hall Road (243 customers) would need to remain out for the duration of the repair while the remaining transformer feeds Beauty Hill Road (158 customers).

Project Objectives

Convert portions of Beauty Hill Rd and Hall Road and remove overloaded parallel 500 kVA step-down transformers on Beauty Hill Rd in Barrington. Install step-down transformers in locations where conversions do not need to occur. Circuit modelling shows new step-down transformers will be less than 80% loading during future summer peaks.

Project Scope

Convert forty overhead 7.2kV transformers to 19.9kV transformers along Beauty Hill Rd and Hall Rd. Remove Parallel 500 kVA step-down transformers on Beauty Hill Rd. Install two 500 kVA step-down transformers on Hall Rd and Beauty Hill Rd beyond converted areas and two 167 kVA step-down transformers on Granville Rd and Lakeside Oaks Rd to minimize conversion costs.

Background / Justification

Aclara line sensor data shows the parallel 500 kVA stepdown transformers on Beauty Hill Road in Barrington have reached a peak value of 1022 kVA which exceeded their 100% rating (102%) during the 2020 summer peak. Beauty Hill Rd is a residential area that consists of 401 customers throughout the year. A stepdown transformer failure due to overload would result in a long outage for Beauty Hill Road customers with the resolution of replacing the failed 500 kVA stepdown transformer with a new 500 kVA stepdown transformer.

Business Process and / or Technical Improvements

This project will eliminate the known overload on parallel 500 kVA step transformers. The removal of the parallel step transformers also eliminates step transformer failure concern for 401 customers on a long radially fed line.

Alternatives Considered with Cost Estimates

Convert Beauty Hill Road and portion of Hall Road – 849,000
Convert 25 sections of Beauty Hill Rd and 54 sections of Hall Road in Barrington NH to remove overloaded parallel stepdown transformers on the 392X7 circuit out of the Rochester AWC. This approach eliminates the parallel 500 kVA stepdown transformers and hanging new stepdown transformers further out on the circuit.

Project Schedule

Milestone/Phase Name	Estimated Date
100% Engineering Completion	Complete
Construction Start	4/1/2021
In Service Date	6/1/2021

Regulatory Approvals

None

REDACTED

EVERSOURCE

Project Authorization Form

Risks and Risk Mitigation Plans

Cost could escalate due to bids or inaccurate estimate assumptions. If the project is bid and the bids are higher than anticipated, additional funding will be sought.

Barrington is CCI's pole maintenance area which could impact scheduling or project costs if CCI declines to set poles. Operations will need to work closely with CCI to ensure the project is completed in a timely manner. If costs increase due to pole setting, supplemental funding will be sought.

Tree trimming is an unknown cost currently. When the project is sent out to bid and the pole set question has been answered the associated trimming costs could increase the project cost.

Contingency

None

References

None

Attachments (One-Line Diagrams, Images, etc.)

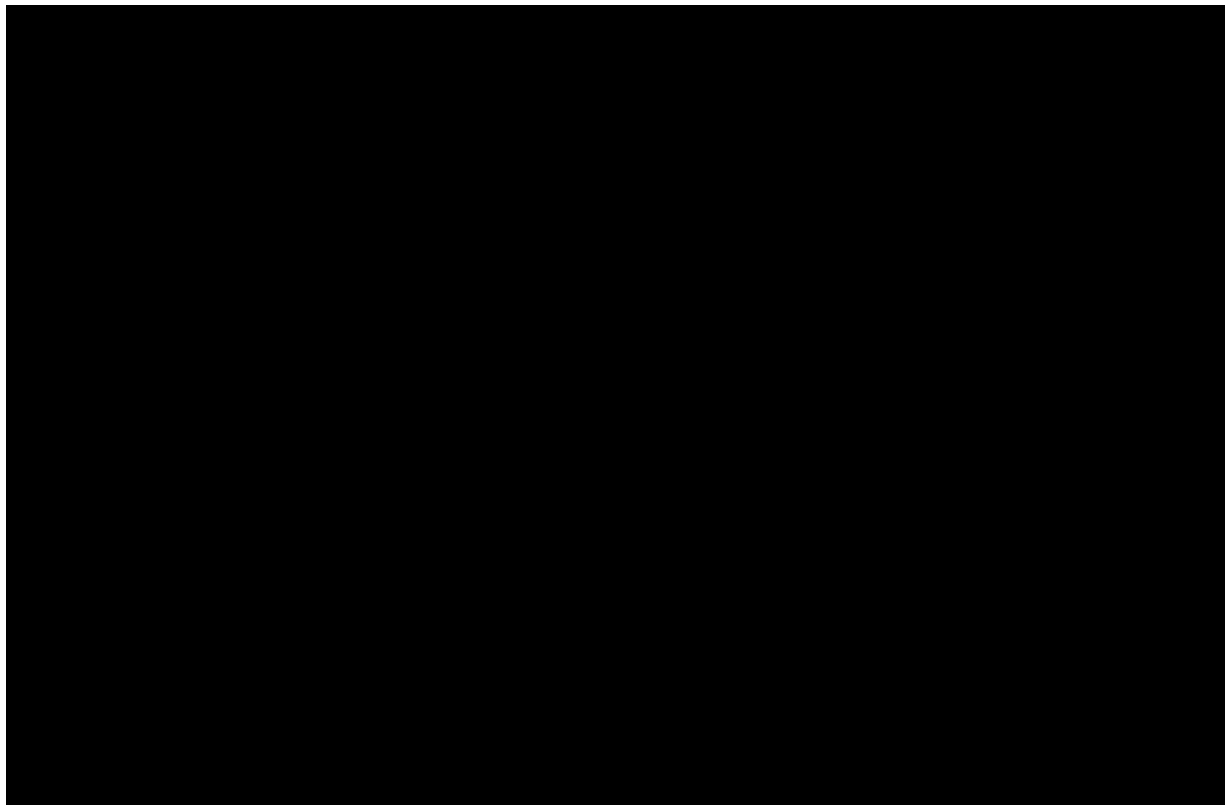

Figure 1: Beauty Hill Rd parallel stepdown transformer area.

REDACTED

EVERSOURCE
Project Authorization Form

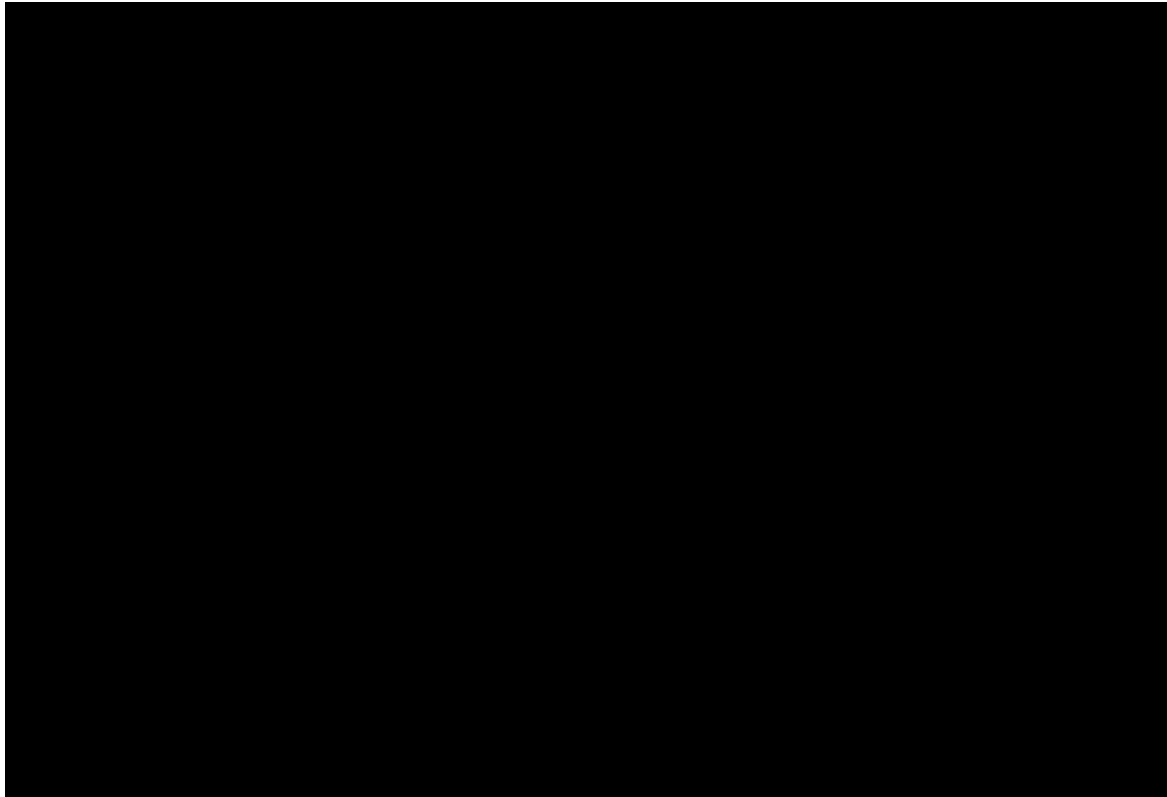

Figure 2: Beauty Hill Rd Conversion with new stepdown transformers.

Cost Estimate Backup Details

Job has been written in Maximo, but estimate function is currently not available. Current estimate based on similar cost associated with work completed on other projects.



Operations Project Authorization Form

Date Prepared: 12/11/2020	Project Title: Distribution Automation Line Sensors
Company/ies: Eversource NH	Project ID Number: A21LS
Organization: NH Field Engineering	Class(es) of Plant: Distribution Line
Project Initiator: Lee Lajoie	Project Category:
Project Manager: Lee Lajoie	Project Type: Specific
Project Sponsor: Paul Renaud	Project Purpose: Load monitoring Line Sensor Installs
Estimated in service date: 12/1/2021	If Transmission Project: PTF? n/a
Eng. /Constr. Resources Budgeted? Yes	Capital Investment Part of Original Operating Plan? Yes
Authorization Type: Full Funding	Facility Type (check all that apply):
Total Request: \$360,000	<input type="checkbox"/> PTF <input type="checkbox"/> non-PTF <input checked="" type="checkbox"/> Distribution

Executive Summary

This PAF requests \$360,000 for Distribution Line Sensor installations. The project is a part of Eversource's NH Distribution Automation strategy. The specific details listed below are for the line sensors to be installed in 2021 throughout the state.

Install Tollgrade® line sensors at various locations on the distribution system throughout the state. The sensors will monitor current at the installation location and communicate with the Eversource NH SCADA. This will increase visibility into the Distribution system and may instigate projects to improve reliability on circuits, reveal load balancing or low voltage situations that need to be resolved, or monitor step transformer loading.

Project Costs Summary *Note: Dollar values are in thousands*

Line item Category	Prior Authorized	Actuals to Date	2021	2022	2023	2024	2025	Total
1. ROW / Easements / Land Acquisition	\$0	\$0	\$0	\$0	\$0	\$0	\$0	\$0
2. Environmental Approvals / Permits	\$0	\$0	\$0	\$0	\$0	\$0	\$0	\$0
3. Outreach	\$0	\$0	\$0	\$0	\$0	\$0	\$0	\$0
4. Siting Approvals / Permits	\$0	\$0	\$0	\$0	\$0	\$0	\$0	\$0
5. Engineering / Design	\$0	\$0	\$0	\$0	\$0	\$0	\$0	\$0
6. Materials (Eversource purchased)	\$0	\$0	\$240	\$0	\$0	\$0	\$0	\$240
7. Construction (incl mat'l's by contractors)	\$0	\$0	\$12	\$0	\$0	\$0	\$0	\$12
8. Testing / Commissioning	\$0	\$0	\$0	\$0	\$0	\$0	\$0	\$0
9. Project Mgmt Team	\$0	\$0	\$0	\$0	\$0	\$0	\$0	\$0
10. Removals	\$0	\$0	\$0	\$0	\$0	\$0	\$0	\$0
11. Other	\$0	\$0	\$0	\$0	\$0	\$0	\$0	\$0
12. Risks	\$0	\$0	\$0	\$0	\$0	\$0	\$0	\$0
SUBTOTAL DIRECTS W/ RISKS	\$0	\$0	\$252	\$0	\$0	\$0	\$0	\$252
13. Indirects/Overhead	\$0	\$0	\$108	\$0	\$0	\$0	\$0	\$108
14. AFUDC	\$0	\$0	\$0	\$0	\$0	\$0	\$0	\$0
PROJECT TOTAL - BASELINE BUDGET	\$0	\$0	\$360	\$0	\$0	\$0	\$0	\$360
15. Contingency	\$0	\$0	\$0	\$0	\$0	\$0	\$0	\$0
TOTAL CAPITAL REQUEST	\$0	\$0	\$360	\$0	\$0	\$0	\$0	\$360
16. Reimbursables/Customer Contribution	\$0	\$0	\$0	\$0	\$0	\$0	\$0	\$0
PROJECT TOTAL (LESS REIMBURSABLES)	\$0	\$0	\$360	\$0	\$0	\$0	\$0	\$360
O&M	\$0	\$0	\$0	\$0	\$0	\$0	\$0	\$0
TOTAL REQUEST	\$0	\$0	\$360	\$0	\$0	\$0	\$0	\$360

Note: Explain unique payment provisions, if applicable: *Provide a detailed breakdown of Other costs here.*



Breakout Costs

Note: Dollar values are in thousands

Line item Category	Prior Authorized	Actuals to Date	2021	2022	2023	2024	2025	Total
ST Labor	\$0	\$0	\$12	\$0	\$0	\$0	\$0	\$12
OT Labor	\$0	\$0	\$0	\$0	\$0	\$0	\$0	\$0
Outside Services Labor	\$0	\$0	\$0	\$0	\$0	\$0	\$0	\$0
Materials*	\$0	\$0	\$240	\$0	\$0	\$0	\$0	\$240
Removals	\$0	\$0	\$0	\$0	\$0	\$0	\$0	\$0
Other	\$0	\$0	\$0	\$0	\$0	\$0	\$0	\$0
Indirects	\$0	\$0	\$108	\$0	\$0	\$0	\$0	\$108
AFUDC	\$0	\$0	\$0	\$0	\$0	\$0	\$0	\$0
TOTAL CAPITAL REQUEST - W/O REIMBURSABLES	\$0	\$0	\$360	\$0	\$0	\$0	\$0	\$360

*All materials including Eversource purchased and outside service purchased. Note that outside service purchased material included in construction in project cost summary above.



Future Financial Impacts:

Provide below the estimated future costs that will result from the project:

Note: Dollar values are in thousands

Future Costs	Year 20__	Year 20__	Year 20__	Year 20__ +	Total Future Project Costs
Capital	\$ -	\$ -	\$ -	\$ -	\$ -
O&M	-	-	-	-	-
Other	-	-	-	-	-
TOTAL \$	-	-	-	-	-

Describe the estimated future Capital, O&M, and/or Other costs noted above:

What functional area(s) will these future costs be funded in? _____

A representative from the respective functional area is required to be included as a project approver.

Provide below the estimated future financial benefits that will result from the project:

Note: Dollar values are in thousands

Future Benefits	Year 20__	Year 20__	Year 20__	Year 20__ +	Total Future Project Benefits
Capital	\$ -	\$ -	\$ -	\$ -	\$ -
O&M	-	-	-	-	-
Other	-	-	-	-	-
TOTAL \$	-	-	-	-	-

Describe the estimated future Capital, O&M, and/or Other benefits noted above:

What functional area(s) will these benefits be reflected in? _____

A representative from the respective functional area is required to be included as a project approver.

Asset Retirement Obligation (ARO) and/ or Environmental Cleanup Costs (Environmental Liabilities):

Is there an ARO associated with this project? No

Are there other environmental cleanup costs associated with this project? No.



Technical Justification

Project Need Statement

This project is a part of Eversource's NH Distribution Automation strategy. The specific details listed below are for the line sensors to be installed in 2021 throughout the state.

Project Objectives

Install Tollgrade® line sensors at various locations on the distribution system throughout the state. The sensors will monitor voltage and current at the installation location and communicate with the Eversource NH SCADA. This will increase visibility into the Distribution system and may instigate projects to improve reliability on circuits, reveal load balancing or low voltage situations that need to be resolved, or monitor step transformer loading.

Project Scope

Install approximately 140 line sensors at various locations on the Eversource NH distribution system.

Background / Justification

Line sensors have previously helped detect line outages and monitor load on circuits. Installing these new line sensors on load side of step transformers and on circuit ties that have a lot of load will continue to help monitor large load on circuits and load growth in new developed areas. It will also improve reliability on circuits and reveal any load balancing issues that needs to be resolved. Some existing 3G models will be replaced with newer 4G models under this project. 3G technology will soon be obsolete rendering the devices unable to communicate.

Business Process and / or Technical Improvements:

Increase visibility into the distribution system by providing loading and voltage information.

Alternatives Considered with Cost Estimates

Install reclosers that will provide load information and alerts of an outage on a circuit. Estimated Cost: \$70,000 - \$80,000 each. 46 three phase installations at \$70,000 each would be \$3.2M.

Project Schedule

Milestone/Phase Name	Estimated Completion Date
Project Completion	12/30/21

Regulatory Approvals

None. Sensors to be installed overhead on existing lines.

Risks and Risk Mitigation Plans

None. Sensors are ordered on an as-needed basis and the project can be halted if sensors are not available

References

None.

Attachments (One-Line Diagrams, Images, etc.)

None.

Cost Estimate Backup Details

Cost estimate based on previous installations.



Operations Project Authorization Form

Date Prepared: 01/15/2021	Project Title: Route 16 Line Relocation NHDOT
Company: Eversource NH	Project Number: A21N28
Organization: Distribution Engineering	Class(es) of Plant: D Line
Project Initiator: Dave Simkins	Project Category: Lines - General
Project Manager: Tom Kane	Project Type: Specific
Project Sponsor: Russel Johnson	Project Purpose: Relocate line for NHDOT
Estimated in service date: 3/1/2021	Capital Investment part of original Oper. Plan: No
Eng./Constr. Resources Budgeted? Yes	O&M Expenses part of original Oper. Plan: No
Authorization Type: Full Funding	Facility Type (check all that apply):
Total Request: \$169,000	<input type="checkbox"/> PTF <input type="checkbox"/> non-PTF <input checked="" type="checkbox"/> Distribution

Executive Summary

This request is for \$169,000 to relocate a temporary line back to its permanent location along Route 16 in Ossipee, NH at the request of the NH Department of Transportation.

The NHDOT has a road and bridge improvement project, #14749, along Route 16 in Ossipee, NH. This required Eversource to relocate approximately 2,500 feet of existing three phase overhead line to a temporary location in accordance with pole licensing requirements and State of NH RSAs. This line must now be moved back to its permanent location so it accessible for line crews.

Project Costs Summary *Note: Dollar values are in thousands*

Line item Category	Prior Authorized	Actuals to Date	2020 to Go	2021	2022	2023	2024	2025	Total
1. ROW / Easements / Land Acquisition	\$0	\$0	\$0	\$0	\$0	\$0	\$0	\$0	\$0
2. Environmental Approvals / Permits	\$0	\$0	\$0	\$0	\$0	\$0	\$0	\$0	\$0
3. Outreach	\$0	\$0	\$0	\$0	\$0	\$0	\$0	\$0	\$0
4. Siting Approvals / Permits	\$0	\$0	\$0	\$0	\$0	\$0	\$0	\$0	\$0
5. Engineering / Design	\$0	\$0	\$0	\$0	\$0	\$0	\$0	\$0	\$0
6. Materials (Eversource purchased)	\$0	\$0	\$0	\$47	\$0	\$0	\$0	\$0	\$47
7. Construction (incl matl's by contractors)	\$0	\$0	\$0	\$67	\$0	\$0	\$0	\$0	\$67
8. Testing / Commissioning	\$0	\$0	\$0	\$0	\$0	\$0	\$0	\$0	\$0
9. Project Mgmt Team	\$0	\$0	\$0	\$0	\$0	\$0	\$0	\$0	\$0
10. Removals	\$0	\$0	\$0	\$0	\$0	\$0	\$0	\$0	\$0
11. Other	\$0	\$0	\$0	\$0	\$0	\$0	\$0	\$0	\$0
12. Risks	\$0	\$0	\$0	\$0	\$0	\$0	\$0	\$0	\$0
SUBTOTAL DIRECTS W/ RISKS	\$0	\$0	\$0	\$114	\$0	\$0	\$0	\$0	\$114
13. Indirects/Overhead	\$0	\$0	\$0	\$54	\$0	\$0	\$0	\$0	\$54
14. AFUDC	\$0	\$0	\$0	\$1	\$0	\$0	\$0	\$0	\$1
PROJECT TOTAL - BASELINE BUDGET	\$0	\$0	\$0	\$169	\$0	\$0	\$0	\$0	\$169
15. Contingency	\$0	\$0	\$0	\$0	\$0	\$0	\$0	\$0	\$0
TOTAL CAPITAL REQUEST	\$0	\$0	\$0	\$169	\$0	\$0	\$0	\$0	\$169
16. Reimbursables/Customer Contribution	\$0	\$0	\$0	\$0	\$0	\$0	\$0	\$0	\$0
PROJECT TOTAL (LESS REIMBURSABLES)	\$0	\$0	\$0	\$169	\$0	\$0	\$0	\$0	\$169
O&M	\$0	\$0	\$0	\$0	\$0	\$0	\$0	\$0	\$0
TOTAL REQUEST	\$0	\$0	\$0	\$169	\$0	\$0	\$0	\$0	\$169

“Other” is a net zero but includes a contingency of \$10,000 to account for the possibility of ledge encountered during pole setting and -\$10,000 in JO Billing.



Breakout Costs

Note: Dollar values are in thousands

Line item Category	Prior Authorized	Actuals to Date	2020 to Go	2021	2022	2023	2024	2025	Total
ST Labor	\$0	\$0	\$0	\$6	\$0	\$0	\$0	\$0	\$6
OT Labor	\$0	\$0	\$0	\$0	\$0	\$0	\$0	\$0	\$0
Outside Services Labor	\$0	\$0	\$0	\$61	\$0	\$0	\$0	\$0	\$61
Materials*	\$0	\$0	\$0	\$47	\$0	\$0	\$0	\$0	\$47
Removals	\$0	\$0	\$0	\$0	\$0	\$0	\$0	\$0	\$0
Other	\$0	\$0	\$0	\$0	\$0	\$0	\$0	\$0	\$0
Indirects	\$0	\$0	\$0	\$54	\$0	\$0	\$0	\$0	\$54
AFUDC	\$0	\$0	\$0	\$1	\$0	\$0	\$0	\$0	\$1
TOTAL CAPITAL REQUEST - W/O REIMBURSABLES	\$0	\$0	\$0	\$169	\$0	\$0	\$0	\$0	\$169

*All materials including Eversource purchased and outside service purchased. Note that outside service purchased material included in construction in project cost summary above.

“Other” is a net zero but includes a contingency of \$10,000 to account for the possibility of ledge encountered during pole setting and -\$10,000 in JO Billing.



Future Financial Impacts:

Provide below the estimated future costs that will result from the project:

Note: Dollar values are in thousands

Future Costs	Year 20__	Year 20__	Year 20__	Year 20__ +	Total Future Project Costs
Capital	\$ -	\$ -	\$ -	\$ -	\$ -
O&M	-	-	-	-	-
Other	-	-	-	-	-
TOTAL \$	-	\$ -	\$ -	\$ -	\$ -

Describe the estimated future Capital, O&M, and/or Other costs noted above:

What functional area(s) will these future costs be funded in? _____
A representative from the respective functional area is required to be included as a project approver.

Provide below the estimated future financial benefits that will result from the project:

Note: Dollar values are in thousands

Future Benefits	Year 20__	Year 20__	Year 20__	Year 20__ +	Total Future Project Benefits
Capital	\$ -	\$ -	\$ -	\$ -	\$ -
O&M	-	-	-	-	-
Other	-	-	-	-	-
TOTAL \$	-	\$ -	\$ -	\$ -	\$ -

Describe the estimated future Capital, O&M, and/or Other benefits noted above:

What functional area(s) will these benefits be reflected in? _____
A representative from the respective functional area is required to be included as a project approver.

Asset Retirement Obligation (ARO) and/ or Environmental Cleanup Costs (Environmental Liabilities):

Is there an ARO associated with this project? No.

Are there other environmental cleanup costs associated with this project? No.



Technical Justification

Project Need Statement

This line relocation project is required in accordance with the State of NH Department of Transportation Utility Accommodation Manual and State of NH pole licensing requirements.

Project Objectives

Relocate approximately 2,500 feet of three phase overhead line along Route 16 in Ossipee, NH to accommodate a State of NH Department of Transportation road and bridge improvement project.

Project Scope

Construct in new location approximately 2,500 feet of three phase overhead line in Ossipee, NH. The new line will require new conductors on new poles.

Background / Justification

This work is required in accordance with the State of NH Department of Transportation Utility Accommodation Manual and State of NH pole licensing requirements.

Business Process and / or Technical Improvements

New line will be constructed in a location agreed to by the ROW owner, the NHDOT.

Alternatives Considered with Cost Estimates

No alternatives were considered, as this work is required by state law.

Project Schedule

Milestone/Phase Name	Estimated Date
100% Engineering Completion	1/22/21
Construction Start	2/1/21
In Service Date	2/28/21

Regulatory Approvals

Normal pole licensing requirements will apply for the new line. No other permits or approvals are required.

Risks and Risk Mitigation Plans

None.

Contingency

A contingency of \$10,000 is included to account for the possibility of encountering ledge during pole setting.

References

None.

Attachments (One-Line Diagrams, Images, etc.)

None.

Cost Estimate Backup Details

Project cost is based on STORMS estimate (#3451633) with Outside Services based on an NTX bid from a contractor.

EVERSOURCE

Request for Initial Funding

Initial Funding Request Form

Date Prepared: 03/08/2021	Project Title: IRU Dark Fiber
Company/ies: Eversource NH	Project Number: A21N46
Organization: Substation Technical Engineering	Class(es) of Plant: Telecom
Project Initiator: Cory Wess	Project Category: Stations - Telecommunications
Project Manager: Todd Kopoyan	Project Type: Specific
Project Sponsor: Roderic Kalbfleisch	Project Purpose: Enable P&C Projects / Compliance
Estimated in service date: 11/01/21	If Transmission Project (check all that apply): PTF <input type="checkbox"/> Non-PTF <input checked="" type="checkbox"/>
Authorization Type: Initial Funding	
Total Request: \$35,000	

Project Need Statement:

The X178/U199 is a long three-terminal 115 kV line between Beebe River, Littleton and Whitefield Substations. The existing leased lines used for System #2 protection (POTT) and for breaker failure transfer trip are very unreliable during faults. There is a need for a more reliable communication solution so that the existing leased lines can be decommissioned.

As of March 9th, 2021 NH Protection and Control Engineering has recommended that the DTT-BF protection be disabled. This recommendation will reduce the possibility of a false trip. As of March 11, 2021 this system has been disabled.

Project Objectives:

The project objective is to develop segments of a SONET telecommunication network in the northern region of NH to enable provisioning of teleprotection circuits. This SONET network will enable subsequent projects to eliminate the existing leased communication lines on the X178/U199 Transmission Line.

These segments will be a combination of Eversource's private fiber facilities and segments of Infeasible Right to Use (IRU) leased dark fiber provided by a third-party fiber vendor (FirstLight Fiber, Inc.). The majority of the build-out (approximately 110 miles and \$970k) under this project will be the leased IRU fiber with an initial twenty-year term. The remainder will be minor additions to extend the fiber from FirstLight's interconnection points into the respective substations and to cross connect this fiber to existing Eversource OPGW.

These fiber ring segments also create the infrastructure to allow Eversource the future opportunity to provide higher communication bandwidth, security and network reliability through other OPGW installations in the region.

EVERSOURCE

Request for Initial Funding

Funding Request Explanation (total request, amount per task, deliverables):

This project is seeking initial funding in the amount of \$35,000 to:

- Develop the scope \$10,000
- Estimate the project \$5,000
- Complete the constructability reviews \$5,000
- Complete conceptual engineering \$10,000
- Other/misc. \$5,000

Preliminary Schedule:

Milestone/Phase Name	Estimated Date
PAF approval, Initial – NH PAC	3/11/21
Conceptual Engineering Completion	03/31/21
PAF approval, Full Funding - NH PAC	03/31/21
Execute First Light Agreement (50% pmt)	4/30/21
Procurement of Materials	05/31/21
Complete Detailed Engineering / IFC Drawings	05/31/21
Construction Start	6/1/21
Construction Complete (Fiber interconnect)	9/1/21
Commissioning/testing (Field Comm.)	11/01/21
In Service Date	11/01/21

REDACTED

EVERSOURCE
Request for Initial Funding

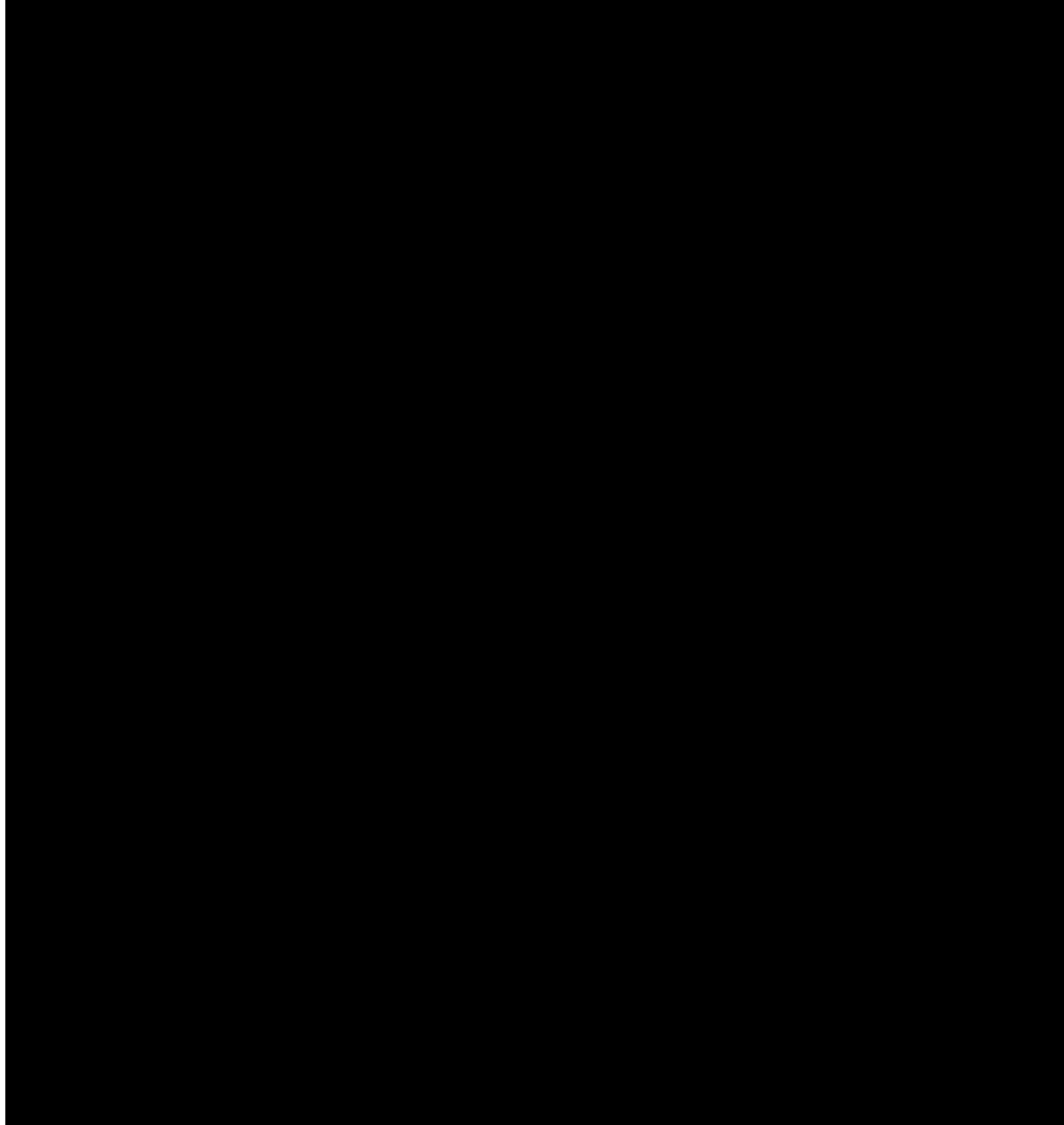



Operations Project Authorization Form

Date Prepared: 01/19/2021	Project Title: Apple Tree Cinema URD Rebuild
Company: Eversource NH	Project Number: A21S12
Organization: Electric System Operations	Class(es) of Plant: D Line
Project Initiator: Julie Walsh	Project Category: Lines - UG Cable
Project Manager: George Loura	Project Type: Specific
Project Sponsor: Russel Johnson	Project Purpose: Replace aging infrastructure
Estimated in service date: 9/1/2021	Capital Investment part of original Oper. Plan: Yes
Eng./Constr. Resources Budgeted? Yes	O&M Expenses part of original Oper. Plan: Yes
Authorization Type: Full Funding	Facility Type (check all that apply):
Total Request: \$357,000	<input type="checkbox"/> PTF <input type="checkbox"/> non-PTF <input checked="" type="checkbox"/> Distribution

Executive Summary

This PAF requests \$357,000 to rebuild the URD system in the Apple Tree Cinema complex in Londonderry NH.

This commercial area on Orchard View Drive in Londonderry is fed from the 365X circuit, and consists of the AMC Apple Tree Cinema, the Workout Club building, and Benson's Hardware. The underground primary facilities serving these customers were built in a non-standard way and are severely deteriorating due to contact with groundwater. This project will rebuild the underground system to current standards.

Project Costs Summary *Note: Dollar values are in thousands*

Line item Category	Prior Authorized	Actuals to Date	2020 to Go	2021	2022	2023	2024	2025	Total
1. ROW / Easements / Land Acquisition	\$0	\$0	\$0	\$0	\$0	\$0	\$0	\$0	\$0
2. Environmental Approvals / Permits	\$0	\$0	\$0	\$0	\$0	\$0	\$0	\$0	\$0
3. Outreach	\$0	\$0	\$0	\$0	\$0	\$0	\$0	\$0	\$0
4. Siting Approvals / Permits	\$0	\$0	\$0	\$0	\$0	\$0	\$0	\$0	\$0
5. Engineering / Design	\$0	\$0	\$0	\$0	\$0	\$0	\$0	\$0	\$0
6. Materials (Eversource purchased)	\$0	\$0	\$0	\$50	\$0	\$0	\$0	\$0	\$50
7. Construction (incl mat'l's by contractors)	\$0	\$0	\$0	\$171	\$0	\$0	\$0	\$0	\$171
8. Testing / Commissioning	\$0	\$0	\$0	\$0	\$0	\$0	\$0	\$0	\$0
9. Project Mgmt Team	\$0	\$0	\$0	\$0	\$0	\$0	\$0	\$0	\$0
10. Removals	\$0	\$0	\$0	\$0	\$0	\$0	\$0	\$0	\$0
11. Other	\$0	\$0	\$0	\$0	\$0	\$0	\$0	\$0	\$0
12. Risks	\$0	\$0	\$0	\$0	\$0	\$0	\$0	\$0	\$0
SUBTOTAL DIRECTS W/ RISKS	\$0	\$0	\$0	\$221	\$0	\$0	\$0	\$0	\$221
13. Indirects/Overhead	\$0	\$0	\$0	\$127	\$0	\$0	\$0	\$0	\$127
14. AFUDC	\$0	\$0	\$0	\$9	\$0	\$0	\$0	\$0	\$9
PROJECT TOTAL – BASELINE BUDGET	\$0	\$0	\$0	\$357	\$0	\$0	\$0	\$0	\$357
15. Contingency	\$0	\$0	\$0	\$0	\$0	\$0	\$0	\$0	\$0
TOTAL CAPITAL REQUEST	\$0	\$0	\$0	\$357	\$0	\$0	\$0	\$0	\$357
16. Reimbursables/Customer Contribution	\$0	\$0	\$0	\$0	\$0	\$0	\$0	\$0	\$0
PROJECT TOTAL (LESS REIMBURSABLES)	\$0	\$0	\$0	\$357	\$0	\$0	\$0	\$0	\$357
O&M	\$0	\$0	\$0	\$0	\$0	\$0	\$0	\$0	\$0
TOTAL REQUEST	\$0	\$0	\$0	\$357	\$0	\$0	\$0	\$0	\$357

Note: Explain unique payment provisions, if applicable: *Provide a detailed breakdown of Other costs here.*



Breakout Costs

Note: Dollar values are in thousands

Line item Category	Prior Authorized	Actuals to Date	2020 to Go	2021	2022	2023	2024	2025	Total
ST Labor	\$0	\$0	\$0	\$2	\$0	\$0	\$0	\$0	\$2
OT Labor	\$0	\$0	\$0	\$0	\$0	\$0	\$0	\$0	\$0
Outside Services Labor	\$0	\$0	\$0	\$168	\$0	\$0	\$0	\$0	\$168
Materials*	\$0	\$0	\$0	\$50	\$0	\$0	\$0	\$0	\$50
Removals	\$0	\$0	\$0	\$0	\$0	\$0	\$0	\$0	\$0
Other	\$0	\$0	\$0	\$1	\$0	\$0	\$0	\$0	\$1
Indirects	\$0	\$0	\$0	\$127	\$0	\$0	\$0	\$0	\$127
AFUDC	\$0	\$0	\$0	\$9	\$0	\$0	\$0	\$0	\$9
TOTAL CAPITAL REQUEST - W/O REIMBURSABLES	\$0	\$0	\$0	\$357	\$0	\$0	\$0	\$0	\$357

*All materials including Eversource purchased and outside service purchased. Note that outside service purchased material included in construction in project cost summary above.



Future Financial Impacts:

Provide below the estimated future costs that will result from the project:

Note: Dollar values are in thousands

Future Costs	Year 20__	Year 20__	Year 20__	Year 20__ +	Total Future Project Costs
Capital	\$ -	\$ -	\$ -	\$ -	\$ -
O&M	-	-	-	-	-
Other	-	-	-	-	-
TOTAL	\$ -	\$ -	\$ -	\$ -	\$ -

Describe the estimated future Capital, O&M, and/or Other costs noted above:

What functional area(s) will these future costs be funded in? _____
A representative from the respective functional area is required to be included as a project approver.

Provide below the estimated future financial benefits that will result from the project:

Note: Dollar values are in thousands

Future Benefits	Year 20__	Year 20__	Year 20__	Year 20__ +	Total Future Project Benefits
Capital	\$ -	\$ -	\$ -	\$ -	\$ -
O&M	-	-	-	-	-
Other	-	-	-	-	-
TOTAL	\$ -	\$ -	\$ -	\$ -	\$ -

Describe the estimated future Capital, O&M, and/or Other benefits noted above:

What functional area(s) will these benefits be reflected in? _____
A representative from the respective functional area is required to be included as a project approver.

Asset Retirement Obligation (ARO) and/ or Environmental Cleanup Costs (Environmental Liabilities):

Is there an ARO associated with this project? No.

Are there other environmental cleanup costs associated with this project? No.



Technical Justification

Project Need Statement

This commercial area on Orchard View Drive in Londonderry is fed from the 365X circuit, and consists of the AMC Apple Tree Cinema, the Workout Club building, and Benson's Hardware (Fig. 1). The underground primary facilities serving these customers were built in a non-standard way and are severely deteriorating due to contact with water runoff (Fig. 2-4). Several of the cabinets fail NESC because they cannot be secured closed due to rot. Others are built on top of cinder blocks, bat and mortar (Fig. 5). Single-phase cables feed into and out of single-phase padmounted sector cabinets. All three transformers are three-phase, and two are live front. This aged URD needs to be replaced with equipment to current standards.

Project Objectives

Replace deteriorating URD equipment and rebuild to current standards.

Project Scope

Install 3500 feet of 34.5 kV URD cable in conduit and associated padmounted equipment including three new three-phase, 4-position sector cabinets, and replacement of two live front three-phase transformers with dead front equipment. Remove old cable where possible, abandon if not. Remove old padmounted equipment and fill.

Background / Justification

This area appears to have been expanded upon over the course of 40 or 50 years. Benson's Hardware was previously a roller-skating rink, and the transformer is from 1974. The transformer for the cinema is from 1981. The present condition is non-standard, is deteriorating, and should be remedied.

Business Process and / or Technical Improvements

Switching of dead-front padmounted equipment can be done without taking an outage. Three-phase customers should be fed by three-phase primary equipment.

Alternatives Considered with Cost Estimates

Replace single phase equipment: \$100,000 estimate for concrete pads, cable splicing, and installing 6 new sector cabinets. *Future risk of equipment becoming damaged again in the same way.

Extend primary cable in conduit from existing padmounted transformer, 32/2GS2T2, and rebuild the remaining URD as specified: \$390,875 estimate. This is the same approximate length of cable as the project proposes, however, this is less desirable because a) this would put customers on the end of another feed and would reduce reliability, and b) this would require either a cable crossing a water drainage main or two road crossings.

Extend primary cable in conduit from a new sector cabinet on Winding Pond Rd. and rebuild the remaining URD as specified: \$390,875 estimate. This is the same approximate length of cable as the project proposes, however, it will add splices to the cable along Winding Pond Rd. and put the commercial URD customers on a long cable with more exposure and would thereby decrease reliability.

Project Schedule

Milestone/Phase Name	Estimated Date
100% Engineering Completion	3/1/2021
Construction Start	7/1/2021
In Service Date	9/1/2021

REDACTED
EVERSOURCE
Project Authorization Form

Regulatory Approvals

None.

Risks and Risk Mitigation Plans

Easement needed to install cable from new riser location.

The project will be put out for bid. If bid amounts are higher than estimated, additional funding will need to be sought with a Supplemental Request.

Contingency

None.

References

None.

Attachments (One-Line Diagrams, Images, etc.)

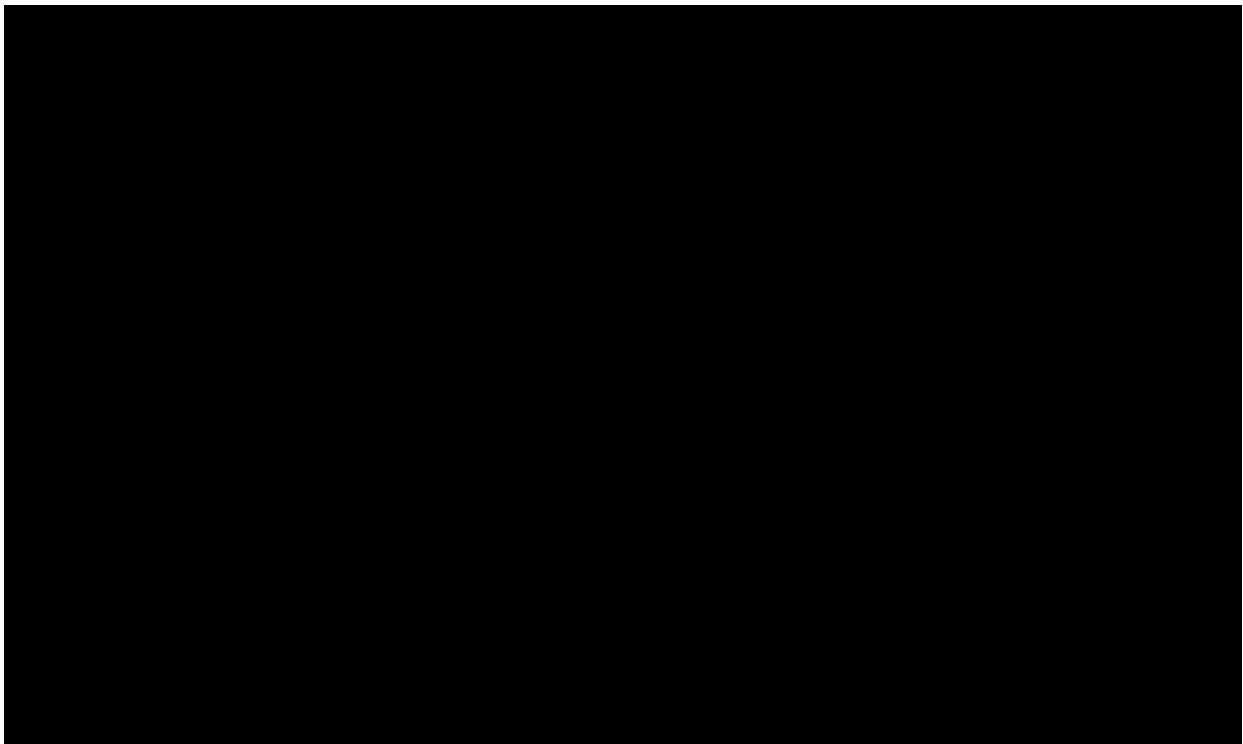

Figure 1

EVERSOURCE
Project Authorization Form



Figure 2

EVERSOURCE
Project Authorization Form



Figure 3

EVERSOURCE
Project Authorization Form



Figure 4

EVERSOURCE

Project Authorization Form



Figure 5

Cost Estimate Backup Details

STORMS WR 3424444
Estimate assumes \$176,432 in outside contractor costs
Estimate is 98% capital



Operations Project Authorization Form

Date Prepared: 01/19/2021	Project Title: Replace Pine Isle Drive URD
Company: Eversource NH	Project Number: A21S13
Organization: Distribution Engineering	Class(es) of Plant: D Line
Project Initiator: Julie Walsh	Project Category: Lines - UG Cable
Project Manager: George Loura	Project Type: Specific
Project Sponsor: Russel Johnson	Project Purpose: Replace aging infrastructure
Estimated in service date: 12/15/2021	Capital Investment part of original Oper. Plan: Yes
Eng./Constr. Resources Budgeted? Yes	O&M Expenses part of original Oper. Plan: Yes
Authorization Type: Full Funding	Facility Type (check all that apply):
Total Request: \$281,000	<input type="checkbox"/> PTF <input type="checkbox"/> non-PTF <input checked="" type="checkbox"/> Distribution

Executive Summary

This PAF requests \$281,000 to replace the direct buried cable along Pine Island Drive in Derry, NH.

Pine Isle Drive, Derry, on the 32W1 circuit, has a 1970's vintage, direct-buried, unjacketed cable infrastructure with non-standard and potentially unsafe equipment.

This project will replace the URD infrastructure with new, single-phase, loop feed cable in conduit. Conduit and padmounted equipment will be located to be accessible from the road. Secondary cables and hand holes will be replaced as needed.

Project Costs Summary *Note: Dollar values are in thousands*

Line item Category	Prior Authorized	Actuals to Date	2020 to Go	2021	2022	2023	2024	2025	Total
1. ROW / Easements / Land Acquisition	\$0	\$0	\$0	\$0	\$0	\$0	\$0	\$0	\$0
2. Environmental Approvals / Permits	\$0	\$0	\$0	\$0	\$0	\$0	\$0	\$0	\$0
3. Outreach	\$0	\$0	\$0	\$0	\$0	\$0	\$0	\$0	\$0
4. Siting Approvals / Permits	\$0	\$0	\$0	\$0	\$0	\$0	\$0	\$0	\$0
5. Engineering / Design	\$0	\$0	\$0	\$0	\$0	\$0	\$0	\$0	\$0
6. Materials (Eversource purchased)	\$0	\$0	\$0	\$40	\$0	\$0	\$0	\$0	\$40
7. Construction (incl mat'l's by contractors)	\$0	\$0	\$0	\$135	\$0	\$0	\$0	\$0	\$135
8. Testing / Commissioning	\$0	\$0	\$0	\$0	\$0	\$0	\$0	\$0	\$0
9. Project Mgmt Team	\$0	\$0	\$0	\$0	\$0	\$0	\$0	\$0	\$0
10. Removals	\$0	\$0	\$0	\$0	\$0	\$0	\$0	\$0	\$0
11. Other	\$0	\$0	\$0	\$0	\$0	\$0	\$0	\$0	\$0
12. Risks	\$0	\$0	\$0	\$0	\$0	\$0	\$0	\$0	\$0
SUBTOTAL DIRECTS W/ RISKS	\$0	\$0	\$0	\$175	\$0	\$0	\$0	\$0	\$175
13. Indirects/Overhead	\$0	\$0	\$0	\$101	\$0	\$0	\$0	\$0	\$101
14. AFUDC	\$0	\$0	\$0	\$5	\$0	\$0	\$0	\$0	\$5
PROJECT TOTAL - BASELINE BUDGET	\$0	\$0	\$0	\$281	\$0	\$0	\$0	\$0	\$281
15. Contingency	\$0	\$0	\$0	\$0	\$0	\$0	\$0	\$0	\$0
TOTAL CAPITAL REQUEST	\$0	\$0	\$0	\$281	\$0	\$0	\$0	\$0	\$281
16. Reimbursables/Customer Contribution	\$0	\$0	\$0	\$0	\$0	\$0	\$0	\$0	\$0
PROJECT TOTAL (LESS REIMBURSABLES)	\$0	\$0	\$0	\$281	\$0	\$0	\$0	\$0	\$281
O&M	\$0	\$0	\$0	\$0	\$0	\$0	\$0	\$0	\$0
TOTAL REQUEST	\$0	\$0	\$0	\$281	\$0	\$0	\$0	\$0	\$281

Note: Explain unique payment provisions, if applicable: *Provide a detailed breakdown of Other costs here.*



Breakout Costs

Note: Dollar values are in thousands

Line item Category	Prior Authorized	Actuals to Date	2020 to Go	2021	2022	2023	2024	2025	Total
ST Labor	\$0	\$0	\$0	\$1	\$0	\$0	\$0	\$0	\$1
OT Labor	\$0	\$0	\$0	\$0	\$0	\$0	\$0	\$0	\$0
Outside Services Labor	\$0	\$0	\$0	\$133	\$0	\$0	\$0	\$0	\$133
Materials*	\$0	\$0	\$0	\$40	\$0	\$0	\$0	\$0	\$40
Removals	\$0	\$0	\$0	\$0	\$0	\$0	\$0	\$0	\$0
Other	\$0	\$0	\$0	\$1	\$0	\$0	\$0	\$0	\$1
Indirects	\$0	\$0	\$0	\$101	\$0	\$0	\$0	\$0	\$101
AFUDC	\$0	\$0	\$0	\$5	\$0	\$0	\$0	\$0	\$5
TOTAL CAPITAL REQUEST - W/O REIMBURSABLES	\$0	\$0	\$0	\$281	\$0	\$0	\$0	\$0	\$281

*All materials including Eversource purchased and outside service purchased. Note that outside service purchased material included in construction in project cost summary above.



Future Financial Impacts:

Provide below the estimated future costs that will result from the project:

Note: Dollar values are in thousands

Future Costs	Year 20__	Year 20__	Year 20__	Year 20__ +	Total Future Project Costs
Capital	\$ -	\$ -	\$ -	\$ -	\$ -
O&M	-	-	-	-	-
Other	-	-	-	-	-
TOTAL	\$ -	\$ -	\$ -	\$ -	\$ -

Describe the estimated future Capital, O&M, and/or Other costs noted above:

What functional area(s) will these future costs be funded in? _____
A representative from the respective functional area is required to be included as a project approver.

Provide below the estimated future financial benefits that will result from the project:

Note: Dollar values are in thousands

Future Benefits	Year 20__	Year 20__	Year 20__	Year 20__ +	Total Future Project Benefits
Capital	\$ -	\$ -	\$ -	\$ -	\$ -
O&M	-	-	-	-	-
Other	-	-	-	-	-
TOTAL	\$ -	\$ -	\$ -	\$ -	\$ -

Describe the estimated future Capital, O&M, and/or Other benefits noted above:

What functional area(s) will these benefits be reflected in? _____
A representative from the respective functional area is required to be included as a project approver.

Asset Retirement Obligation (ARO) and/ or Environmental Cleanup Costs (Environmental Liabilities):

Is there an ARO associated with this project? No.

Are there other environmental cleanup costs associated with this project? No.



Technical Justification

Project Need Statement

Pine Isle Drive is an aging direct-buried URD with multiple problems, including inaccessible live-front transformers, a history of cable failures, and safety issues such as an overhead transformer on a slab inside a metal cabinet.

Project Objectives

Proactively replace aging URD infrastructure with new equipment to current standards and provide a loop feed for 66 customers.

Project Scope

Install approximately 2400 feet of single-phase 1/0 URD cable in conduit from riser pole 1/17Y to one new sector cabinet, then loop feed to five pad-mounted transformers. Install approximately 700 feet of secondary cable to hand holes. Remove existing above-ground equipment and abandon cable.

Background / Justification

URD is old, direct-buried cable. Feed into the 66-customer development is a three-phase unjacketed cable with a failed phase. Transformers are placed well into the woods behind buildings and are not accessible from the road. T5 is not a pad-mounted transformer as the map shows but is an overhead transformer on a slab with an old arrester cabinet covering it. Much of the secondary has failed over the years, being patched, replaced, or reconfigured. One transformer was replaced in 2014. Three others are 1970's vintage. The age of the overhead transformer in the metal cabinet is unknown.

Business Process and / or Technical Improvements

Project will provide customers with a loop feed and new equipment, and line personnel with accessible equipment safer to operate. Lengthy outages due to failure of direct buried cable can be avoided.

Alternatives Considered with Cost Estimates

Replace failed equipment as needed.

Project Schedule

Milestone/Phase Name	Estimated Date
100% Engineering Completion	4/1/2021
Construction Start	7/1/2021
In Service Date	10/1/2021

Regulatory Approvals

None.

Risks and Risk Mitigation Plans

This project will be put out to bid. If bids are higher than estimated, additional funding will be sought.

Contingency

None.

References

None.

REDACTED

EVERSOURCE
Project Authorization Form

Attachments (One-Line Diagrams, Images, etc.)

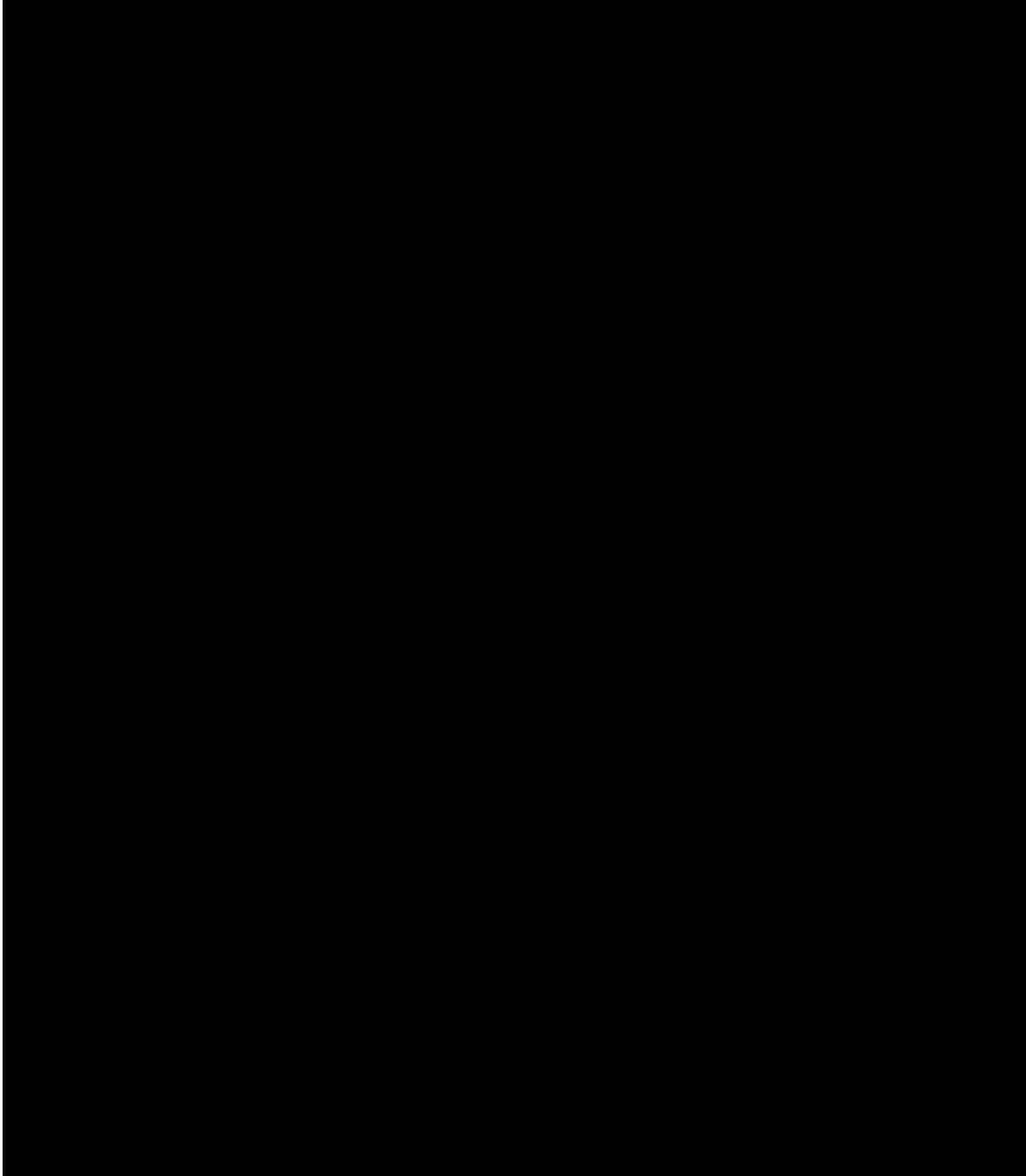

Figure 1

EVERSOURCE
Project Authorization Form



Figure 2



Figure 3

EVERSOURCE
Project Authorization Form



Figure 4

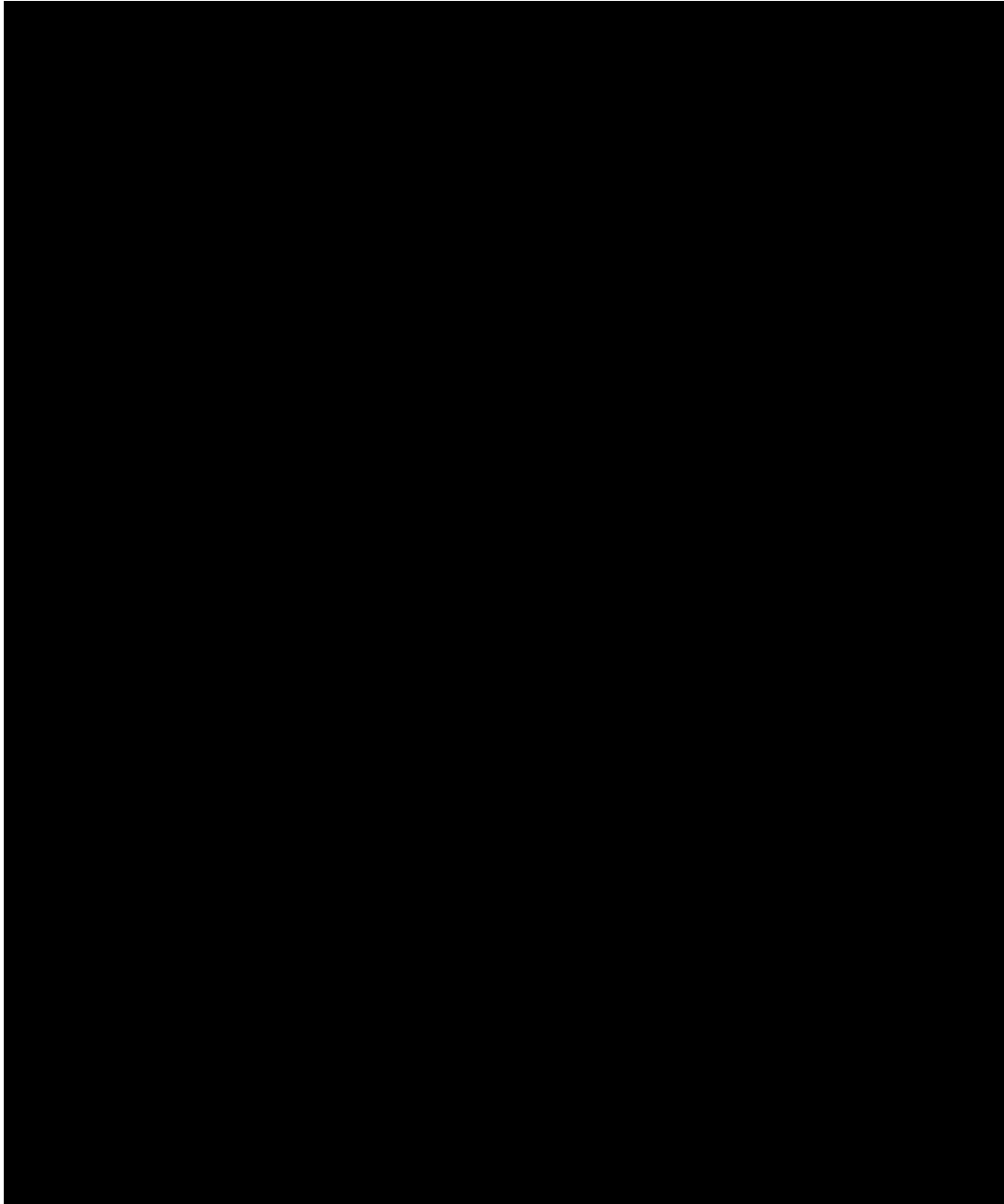

Figure 5

Cost Estimate Backup Details

\$130/foot estimate based on Maple Hills URD replacement costs.



Operations Project Authorization Form

Date Prepared: 01/19/2021	Project Title: Damren Rd. Conversion
Company: Eversource NH	Project Number: A21S27
Organization: Electric System Operations	Class(es) of Plant: D Line
Project Initiator: Julie Walsh	Project Category: Lines - General
Project Manager: George Loura	Project Type: Specific
Project Sponsor: Russel Johnson	Project Purpose: Reduce loading on overloaded step transformer
Estimated in service date: 6/1/2021	Capital Investment part of original Oper. Plan: Yes
Eng./Constr. Resources Budgeted? Yes	O&M Expenses part of original Oper. Plan: Yes
Authorization Type: Full Funding	Facility Type (check all that apply):
Total Request: \$214,000	<input type="checkbox"/> PTF <input type="checkbox"/> non-PTF <input checked="" type="checkbox"/> Distribution

Executive Summary

This PAF seeks \$214,000 to convert Damren Road in Derry, NH to relieve an overloaded step transformer.

Damren road is on the 3141X circuit. The single-phase line on Damren Rd. is stepped down from 19.9 kV to 7.2 kV and the load on this step transformer was measured at 150% of nameplate in July of 2020. This project will convert approximately 2500 feet of single phase to 19.9 kV, and split the load between two steps, maintaining the 7.2 kV tie to the Adams Pond Rd. step.

Project Costs Summary *Note: Dollar values are in thousands*

Line item Category	Prior Authorized	Actuals to Date	2020 to Go	2021	2022	2023	2024	2025	Total
1. ROW / Easements / Land Acquisition	\$0	\$0	\$0	\$0	\$0	\$0	\$0	\$0	\$0
2. Environmental Approvals / Permits	\$0	\$0	\$0	\$0	\$0	\$0	\$0	\$0	\$0
3. Outreach	\$0	\$0	\$0	\$0	\$0	\$0	\$0	\$0	\$0
4. Siting Approvals / Permits	\$0	\$0	\$0	\$0	\$0	\$0	\$0	\$0	\$0
5. Engineering / Design	\$0	\$0	\$0	\$0	\$0	\$0	\$0	\$0	\$0
6. Materials (Eversource purchased)	\$0	\$0	\$0	\$15	\$0	\$0	\$0	\$0	\$15
7. Construction (incl mat'l's by contractors)	\$0	\$0	\$0	\$96	\$0	\$0	\$0	\$0	\$96
8. Testing / Commissioning	\$0	\$0	\$0	\$0	\$0	\$0	\$0	\$0	\$0
9. Project Mgmt Team	\$0	\$0	\$0	\$0	\$0	\$0	\$0	\$0	\$0
10. Removals	\$0	\$0	\$0	\$0	\$0	\$0	\$0	\$0	\$0
11. Other	\$0	\$0	\$0	\$0	\$0	\$0	\$0	\$0	\$0
12. Risks	\$0	\$0	\$0	\$0	\$0	\$0	\$0	\$0	\$0
SUBTOTAL DIRECTS W/ RISKS	\$0	\$0	\$0	\$111	\$0	\$0	\$0	\$0	\$111
13. Indirects/Overhead	\$0	\$0	\$0	\$98	\$0	\$0	\$0	\$0	\$98
14. AFUDC	\$0	\$0	\$0	\$5	\$0	\$0	\$0	\$0	\$5
PROJECT TOTAL – BASELINE BUDGET	\$0	\$0	\$0	\$214	\$0	\$0	\$0	\$0	\$214
15. Contingency	\$0	\$0	\$0	\$0	\$0	\$0	\$0	\$0	\$0
TOTAL CAPITAL REQUEST	\$0	\$0	\$0	\$214	\$0	\$0	\$0	\$0	\$214
16. Reimbursables/Customer Contribution	\$0	\$0	\$0	\$0	\$0	\$0	\$0	\$0	\$0
PROJECT TOTAL (LESS REIMBURSABLES)	\$0	\$0	\$0	\$214	\$0	\$0	\$0	\$0	\$214
O&M	\$0	\$0	\$0	\$0	\$0	\$0	\$0	\$0	\$0
TOTAL REQUEST	\$0	\$0	\$0	\$214	\$0	\$0	\$0	\$0	\$214

Note: Explain unique payment provisions, if applicable: *Provide a detailed breakdown of Other costs here.*



Breakout Costs

Note: Dollar values are in thousands

Line item Category	Prior Authorized	Actuals to Date	2020 to Go	2021	2022	2023	2024	2025	Total
ST Labor	\$0	\$0	\$0	\$42	\$0	\$0	\$0	\$0	\$42
OT Labor	\$0	\$0	\$0	\$0	\$0	\$0	\$0	\$0	\$0
Outside Services Labor	\$0	\$0	\$0	\$39	\$0	\$0	\$0	\$0	\$39
Materials*	\$0	\$0	\$0	\$15	\$0	\$0	\$0	\$0	\$15
Removals	\$0	\$0	\$0	\$0	\$0	\$0	\$0	\$0	\$0
Other	\$0	\$0	\$0	\$15	\$0	\$0	\$0	\$0	\$15
Indirects	\$0	\$0	\$0	\$98	\$0	\$0	\$0	\$0	\$98
AFUDC	\$0	\$0	\$0	\$5	\$0	\$0	\$0	\$0	\$5
TOTAL CAPITAL REQUEST - W/O REIMBURSABLES	\$0	\$0	\$0	\$214	\$0	\$0	\$0	\$0	\$214

*All materials including Eversource purchased and outside service purchased. Note that outside service purchased material included in construction in project cost summary above.



Future Financial Impacts:

Provide below the estimated future costs that will result from the project:

Note: Dollar values are in thousands

Future Costs	Year 20__	Year 20__	Year 20__	Year 20__ +	Total Future Project Costs
Capital	\$ -	\$ -	\$ -	\$ -	\$ -
O&M	-	-	-	-	-
Other	-	-	-	-	-
TOTAL	\$ -	\$ -	\$ -	\$ -	\$ -

Describe the estimated future Capital, O&M, and/or Other costs noted above:

What functional area(s) will these future costs be funded in? _____
A representative from the respective functional area is required to be included as a project approver.

Provide below the estimated future financial benefits that will result from the project:

Note: Dollar values are in thousands

Future Benefits	Year 20__	Year 20__	Year 20__	Year 20__ +	Total Future Project Benefits
Capital	\$ -	\$ -	\$ -	\$ -	\$ -
O&M	-	-	-	-	-
Other	-	-	-	-	-
TOTAL	\$ -	\$ -	\$ -	\$ -	\$ -

Describe the estimated future Capital, O&M, and/or Other benefits noted above:

What functional area(s) will these benefits be reflected in? _____
A representative from the respective functional area is required to be included as a project approver.

Asset Retirement Obligation (ARO) and/ or Environmental Cleanup Costs (Environmental Liabilities):

Is there an ARO associated with this project? No.

Are there other environmental cleanup costs associated with this project? No.

EVERSOURCE

Project Authorization Form

Technical Justification

Project Need Statement

Load measured on 500 kVA step transformer feeding Damren Road is over 150% of nameplate. Area growth over the years has overloaded the step transformer.

Project Objectives

Reduce loading on the step while allowing for future residential growth.

Project Scope

2500 feet of single phase conversion from 7.2-19.9 kV. Remove overloaded 500 kVA. Replace with two 500 kVA steps, one feeding down Walnut Hill (to open point with Adams Pond Rd. step as back feed), and one feeding the end of Damren Rd. and a large trailer park.

Background / Justification

The single-phase line on Damren Rd. is stepped down from 19.9 kV to 7.2 kV about 2200 feet before the intersection of Walnut Hill Rd. This transformer meter was read in July 2020 and shows a peak demand of 777 kVA, which puts it at over 150% of nameplate. There are 335 customers on the step currently, with 215 of those at the very end of Damren Rd. in a trailer park. This project will convert approximately 2500 feet of single phase 7.2 kV line to 19.9 kV, and split the load between two steps, maintaining the 7.2 kV tie to the Adams Pond Rd. step.

Business Process and / or Technical Improvements

Avoid transformer failure due to overload, and the associated lengthy outage.

Alternatives Considered with Cost Estimates

Offload customers on Walnut Hill to Adams Pond Rd step. This would be costs to set up reconfiguration switching only. However, this would effectively eliminate the option to backfeed the Adams Pond Rd. step from Damren Rd, resulting in reduced reliability.

Project Schedule

Milestone/Phase Name	Estimated Date
100% Engineering Completion	3/1/2021
Construction Start	4/1/2021
In Service Date	6/1/2021

Regulatory Approvals

None.

Risks and Risk Mitigation Plans

Job has not been designed and estimated. Should costs exceed the amount shown, supplemental funding will be needed.

Contingency

None.

References

None.



Attachments (One-Line Diagrams, Images, etc.)

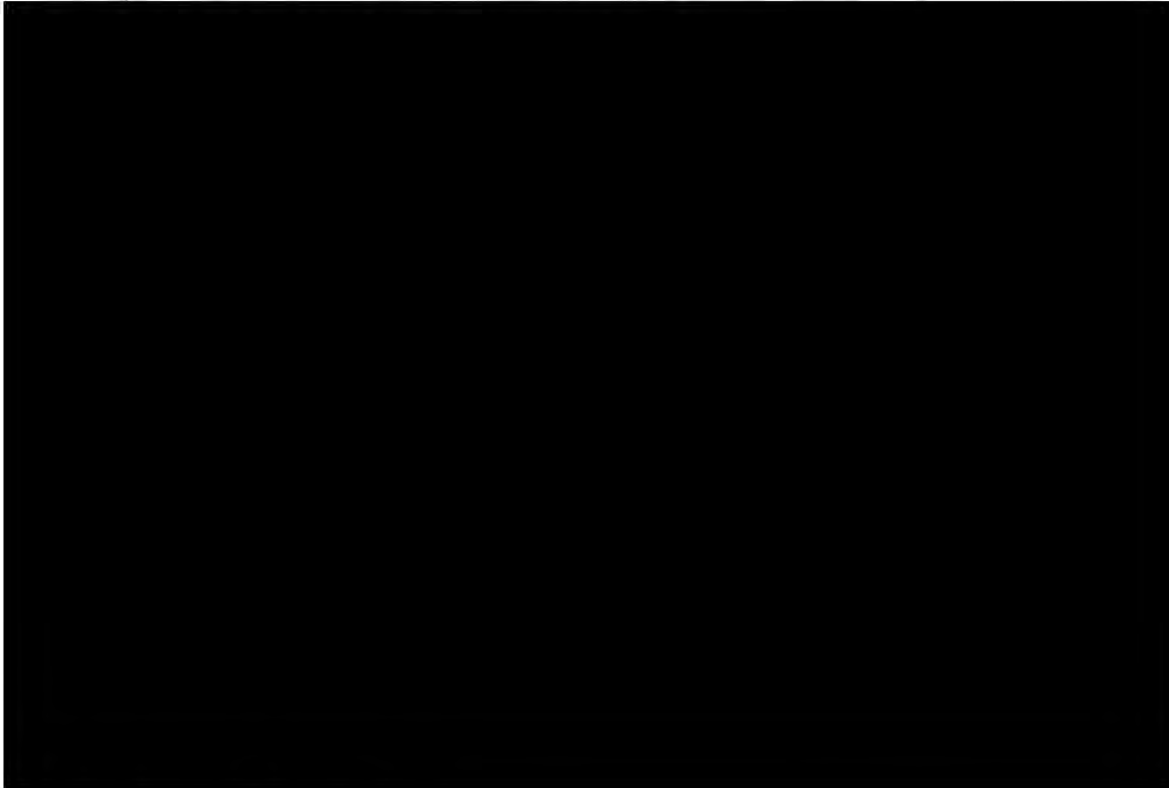

Cost Estimate Backup Details

Starting with an estimated \$100/foot for single phase conversion. This estimate was lowered to \$90/foot based on many of the poles and all of the wire looking to be in good shape.



Operations Project Authorization Form

Date Prepared: 01/22/2021	Project Title: Remove Lattice Steel Towers – W15
Company: Eversource NH	Project Number: A21W36
Organization: Electric Field Operations	Class(es) of Plant: D Line
Project Initiator: Josh Letourneau	Project Category: Lines - Structures
Project Manager: Tom Davis	Project Type: Specific
Project Sponsor: Mark Sandler	Project Purpose: Reliability – Right of Way
Estimated in service date: 12/31/2021	Capital Investment part of original Oper. Plan: Yes
Eng./Constr. Resources Budgeted? Yes	O&M Expenses part of original Oper. Plan: Yes
Authorization Type: Full Funding	Facility Type (check all that apply):
Total Request: \$250,000	<input type="checkbox"/> PTF <input type="checkbox"/> non-PTF <input checked="" type="checkbox"/> Distribution

Executive Summary

An approval of \$250,000 is requested under project A21W36 to remove lattice steel towers on the W15 line. The specific work has been identified based on current lattice tower conditions and line sections classified as a potential risk to safety. 2021 work will be to remove structures on the abandoned section of the W15 circuit in Marlborough, Harrisville, and Dublin. There are additional removals to be done and funding will be sought in future years.

Project Costs Summary *Note: Dollar values are in thousands*

Line item Category	Prior Authorized	Actuals to Date	2020 to Go	2021	2022	2023	2024	2025	Total
1. ROW / Easements / Land Acquisition	\$0	\$0	\$0	\$0	\$0	\$0	\$0	\$0	\$0
2. Environmental Approvals / Permits	\$0	\$0	\$0	\$0	\$0	\$0	\$0	\$0	\$0
3. Outreach	\$0	\$0	\$0	\$0	\$0	\$0	\$0	\$0	\$0
4. Siting Approvals / Permits	\$0	\$0	\$0	\$0	\$0	\$0	\$0	\$0	\$0
5. Engineering / Design	\$0	\$0	\$0	\$0	\$0	\$0	\$0	\$0	\$0
6. Materials (Eversource purchased)	\$0	\$0	\$0	\$25	\$0	\$0	\$0	\$0	\$25
7. Construction (incl mat'l's by contractors)	\$0	\$0	\$0	\$10	\$0	\$0	\$0	\$0	\$10
8. Testing / Commissioning	\$0	\$0	\$0	\$0	\$0	\$0	\$0	\$0	\$0
9. Project Mgmt Team	\$0	\$0	\$0	\$7	\$0	\$0	\$0	\$0	\$7
10. Removals	\$0	\$0	\$0	\$106	\$0	\$0	\$0	\$0	\$106
11. Other	\$0	\$0	\$0	\$0	\$0	\$0	\$0	\$0	\$0
12. Risks	\$0	\$0	\$0	\$0	\$0	\$0	\$0	\$0	\$0
SUBTOTAL DIRECTS W/ RISKS	\$0	\$0	\$0	\$148	\$0	\$0	\$0	\$0	\$148
13. Indirects/Overhead	\$0	\$0	\$0	\$101	\$0	\$0	\$0	\$0	\$101
14. AFUDC	\$0	\$0	\$0	\$1	\$0	\$0	\$0	\$0	\$1
PROJECT TOTAL – BASELINE BUDGET	\$0	\$0	\$0	\$250	\$0	\$0	\$0	\$0	\$250
15. Contingency	\$0	\$0	\$0	\$0	\$0	\$0	\$0	\$0	\$0
TOTAL CAPITAL REQUEST	\$0	\$0	\$0	\$250	\$0	\$0	\$0	\$0	\$250
16. Reimbursables/Customer Contribution	\$0	\$0	\$0	\$0	\$0	\$0	\$0	\$0	\$0
PROJECT TOTAL (LESS REIMBURSABLES)	\$0	\$0	\$0	\$250	\$0	\$0	\$0	\$0	\$250
O&M									
TOTAL REQUEST	\$0	\$0	\$0	\$250	\$0	\$0	\$0	\$0	\$250

Note: Explain unique payment provisions, if applicable: *Provide a detailed breakdown of Other costs here.*



Breakout Costs

Note: Dollar values are in thousands

Line item Category	Prior Authorized	Actuals to Date	2020	2021	2022	2023	2024	2025	Total
ST Labor	\$0	\$0	\$0	\$7	\$0	\$0	\$0	\$0	\$7
OT Labor	\$0	\$0	\$0	\$0	\$0	\$0	\$0	\$0	\$0
Outside Services Labor	\$0	\$0	\$0	\$10	\$0	\$0	\$0	\$0	\$10
Materials*	\$0	\$0	\$0	\$25	\$0	\$0	\$0	\$0	\$25
Removals	\$0	\$0	\$0	\$106	\$0	\$0	\$0	\$0	\$106
Other	\$0	\$0	\$0	\$0	\$0	\$0	\$0	\$0	\$0
Indirects	\$0	\$0	\$0	\$101	\$0	\$0	\$0	\$0	\$101
AFUDC	\$0	\$0	\$0	\$1	\$0	\$0	\$0	\$0	\$1
TOTAL CAPITAL REQUEST - W/O REIMBURSABLES	\$0	\$0	\$0	\$250	\$0	\$0	\$0	\$0	\$250

*All materials including Eversource purchased and outside service purchased. Note that outside service purchased material included in construction in project cost summary above.



Future Financial Impacts:

Provide below the estimated future costs that will result from the project:

Note: Dollar values are in thousands

Future Costs	Year 20__	Year 20__	Year 20__	Year 20__ +	Total Future Project Costs
Capital	\$ -	\$ -	\$ -	\$ -	\$ -
O&M	-	-	-	-	-
Other	-	-	-	-	-
TOTAL	\$ -	\$ -	\$ -	\$ -	\$ -

Describe the estimated future Capital, O&M, and/or Other costs noted above:

What functional area(s) will these future costs be funded in? _____
A representative from the respective functional area is required to be included as a project approver.

Provide below the estimated future financial benefits that will result from the project:

Note: Dollar values are in thousands

Future Benefits	Year 20__	Year 20__	Year 20__	Year 20__ +	Total Future Project Benefits
Capital	\$ -	\$ -	\$ -	\$ -	\$ -
O&M	-	-	-	-	-
Other	-	-	-	-	-
TOTAL	\$ -	\$ -	\$ -	\$ -	\$ -

Describe the estimated future Capital, O&M, and/or Other benefits noted above:

What functional area(s) will these benefits be reflected in? _____
A representative from the respective functional area is required to be included as a project approver.

Asset Retirement Obligation (ARO) and/ or Environmental Cleanup Costs (Environmental Liabilities):

Is there an ARO associated with this project? No.

Are there other environmental cleanup costs associated with this project? No

EVERSOURCE

Project Authorization Form

Technical Justification

Project Need Statement

This project is intended to remove old lattice steel towers in the W15 distribution Right of Way. Work under this project in 2021 will be to remove structures on the abandoned section of the W15 circuit in Marlborough, Harrisville, and Dublin.

Project Objectives

This project will provide funding for the removal of degraded steel lattice tower structures in the W15 right of way to avoid future failures, and/or comply with regulatory, statutory, and intracompany requirements and agreements.

Project Scope

This project will remove approximately 11 miles/structures of the W15 circuit in Western Region. There are approximately five miles of line to be addressed and it is planned to seek funding for additional section in future years. Environmental controls and access may impact the number of structures able to be completed each year.

Background / Justification

Removal of abandoned lines is required by the NESC and is a Company objective.

Business Process and / or Technical Improvements

Removal of obsolete and potentially unsafe lattice steel structures.

Alternatives Considered with Cost Estimates

Not applicable.

Project Schedule

Milestone/Phase Name	Estimated Date
100% Engineering Completion	February 15, 2021
Environmental Permitting and off ROW Access	February 28, 2021
Construction Start	March 1, 2021
In Service	April 1, 2021

Regulatory Approvals

The construction budget is submitted to the New Hampshire Public Utilities Commission in accordance with Rule Puc 308.07 using Form E-22. Also on a quarterly basis projects not previously reported in the annual construction budget that have exceeded \$100,000 are reported to the New Hampshire Public Utilities Commission.

Risks and Risk Mitigation Plans

Financial: Environmental access and cleanup costs may increase in cost which would reduce the total number of structures to be removed to keep the project within total approved cost. Spending will be monitored to ensure the Authorized Amount is not exceeded.

Operational: Structures will be reviewed to ensure unequal stresses are not induced on remaining structures to avoid mechanical failure until these remaining structures can be removed. Anchors and guying will be installed to properly deadend conductors.



Contingency

N/A

References

Not applicable

Attachments (One-Line Diagrams, Images, etc.)

None.

Cost Estimate Backup Details

Work progress and expenditures will be monitored to ensure the authorized amount is not exceeded.



Operations Project Authorization Form

Date Prepared: 02/03/2021	Project Title: Extend Three Phase Route 202 Rindge 3120X3
Company: Eversource NH	Project Number: A21W37
Organization: Distribution Engineering	Class(es) of Plant: D Line
Project Initiator: Mark Fraser	Project Category: Lines - Conductor
Project Manager: Mark Fraser	Project Type: Specific
Project Sponsor: Russel Johnson	Project Purpose: To Meet General Load Growth
Estimated in service date: 6/1/2021	Capital Investment part of original Oper. Plan: No
Eng./Constr. Resources Budgeted? No	O&M Expenses part of original Oper. Plan: No
Authorization Type: Full Funding	Facility Type (check all that apply):
Total Request: \$338,000	<input type="checkbox"/> PTF <input type="checkbox"/> non-PTF <input checked="" type="checkbox"/> Distribution

Executive Summary

This PAF seeks \$338,000 to extend three-phase spacer cable 1,900 feet south on Route 202 in Rindge, NH in the Keene Area Work Center. This would extend the 3120X3 down from the intersection with Rand/Dean Farm Roads to Forristall/Middle Winchendon Roads. A minor conversion impacting only one transformer will extend 19.9 kV 4,000 feet further down Route 202.

The south end of Route 202 and Forristall Road are fed from an overloaded 500 kVA step (533 kW) located on Middle Winchendon Road. This line extension would remove 174 customers off the step and provide a stronger source down to commercial customers near the Massachusetts border.

Extending three phase primary is important as Route 202 is the primary commercial area for Rindge and leads directly into Massachusetts. Also, Lake Monomonac is located down line of this upgrade and has seen significant growth as cottages are being turned into year-round homes. All this load is fed from the 3120X4. We are currently under-fused on Wellington Road, a major feed to the lake from the 3120X4 due to max fusing limitations. The load needs to be balanced and spread to other sources like this proposed Route 202 feed.

This project is to be built by contractors. The total cost of the project is estimated at \$338,000 and is 99% capital.

Project Costs Summary *Note: Dollar values are in thousands*

Line item Category	Prior Authorized	Actuals to Date	2021	2022	2023	Total
1. ROW / Easements / Land Acquisition	\$0	\$0	\$0	\$0	\$0	\$0
2. Environmental Approvals / Permits	\$0	\$0	\$0	\$0	\$0	\$0
3. Outreach	\$0	\$0	\$0	\$0	\$0	\$0
4. Siting Approvals / Permits	\$0	\$0	\$0	\$0	\$0	\$0
5. Engineering / Design	\$0	\$0	\$0	\$0	\$0	\$0
6. Materials (Eversource purchased)	\$0	\$0	\$35	\$0	\$0	\$35
7. Construction (incl mat'l's by contractors)	\$0	\$0	\$160	\$0	\$0	\$160
8. Testing / Commissioning	\$0	\$0	\$0	\$0	\$0	\$0
9. Project Mgmt Team	\$0	\$0	\$20	\$0	\$0	\$20
10. Removals	\$0	\$0	\$0	\$0	\$0	\$0
11. Other	\$0	\$0	\$0	\$0	\$0	\$0
12. Risks	\$0	\$0	\$0	\$0	\$0	\$0
SUBTOTAL DIRECTS W/ RISKS	\$0	\$0	\$215	\$0	\$0	\$215
13. Indirects/Overhead	\$0	\$0	\$122	\$0	\$0	\$122
14. AFUDC	\$0	\$0	\$1	\$0	\$0	\$1
PROJECT TOTAL – BASELINE BUDGET	\$0	\$0	\$338	\$0	\$0	\$338
15. Contingency	\$0	\$0	\$0	\$0	\$0	\$0
TOTAL CAPITAL REQUEST	\$0	\$0	\$338	\$0	\$0	\$338
16. Reimbursables/Customer Contribution	\$0	\$0	\$0	\$0	\$0	\$0
PROJECT TOTAL (LESS REIMBURSABLES)	\$0	\$0	\$338	\$0	\$0	\$338
O&M	\$0	\$0	\$0	\$0	\$0	\$0
TOTAL REQUEST	\$0	\$0	\$338	\$0	\$0	\$338

Note: Explain unique payment provisions, if applicable: *Provide a detailed breakdown of Other costs here.*



Breakout Costs

Note: Dollar values are in thousands

Line item Category	Prior Authorized	Actuals to Date	2021	2022	2023	Total
ST Labor	\$0	\$0	\$20	\$0	\$0	\$20
OT Labor	\$0	\$0	\$0	\$0	\$0	\$0
Outside Services Labor	\$0	\$0	\$160	\$0	\$0	\$160
Materials*	\$0	\$0	\$35	\$0	\$0	\$35
Removals	\$0	\$0	\$0	\$0	\$0	\$0
Other	\$0	\$0	\$0	\$0	\$0	\$0
Indirects	\$0	\$0	\$122	\$0	\$0	\$122
AFUDC	\$0	\$0	\$1	\$0	\$0	\$1
TOTAL CAPITAL REQUEST - W/O REIMBURSABLES	\$0	\$0	\$338	\$0	\$0	\$338

*All materials including Eversource purchased and outside service purchased. Note that outside service purchased material included in construction in project cost summary above.



Future Financial Impacts: No future costs are anticipated.

Provide below the estimated future costs that will result from the project:

Note: Dollar values are in thousands

Future Costs	Year 20__	Year 20__	Year 20__	Year 20__ +	Total Future Project Costs
Capital	\$ -	\$ -	\$ -	\$ -	\$ -
O&M	-	-	-	-	-
Other	-	-	-	-	-
TOTAL \$	-	\$ -	\$ -	\$ -	\$ -

Describe the estimated future Capital, O&M, and/or Other costs noted above:

What functional area(s) will these future costs be funded in? _____

A representative from the respective functional area is required to be included as a project approver.

Provide below the estimated future financial benefits that will result from the project:

Note: Dollar values are in thousands

Future Benefits	Year 20__	Year 20__	Year 20__	Year 20__ +	Total Future Project Benefits
Capital	\$ -	\$ -	\$ -	\$ -	\$ -
O&M	-	-	-	-	-
Other	-	-	-	-	-
TOTAL \$	-	\$ -	\$ -	\$ -	\$ -

Describe the estimated future Capital, O&M, and/or Other benefits noted above:

What functional area(s) will these benefits be reflected in? _____

A representative from the respective functional area is required to be included as a project approver.

Asset Retirement Obligation (ARO) and/ or Environmental Cleanup Costs (Environmental Liabilities):

Is there an ARO associated with this project? If yes, please provide details: No

Are there other environmental cleanup costs associated with this project? No.



Technical Justification

Project Need Statement

Rindge is the one of the fastest growing towns in the Mondadnock region. From 2019 to 2020, residential building permits increased by 50%. Two large subdivision with over thirty residences are also planned for 2021 along with many single lot homes in progress. Along Route 202, the town is looking to rezone an area from general agriculture to light manufacturing for medical device company proposed facility.

Rindge is primarily fed from circuits 3120X3 and 3120X4. Most of the town is fed from the radial 3120X4 which is limited by fusing. Load growth is starting to necessitate moving fuses down line increasing exposure. For example, the max fuse beyond the 3120X4R2 is 65T/80T. The loading on Wellington Road beyond the existing hydraulic recloser is at 89 amps.

The immediate need is to offload the overloaded step on Middle Winchendon Road. This project will remove 174 customers of load from this step. Bringing three phases down to Route 202 and converting the existing single-phase line to 35 kV and additional 4,000 down toward the Massachusetts' line will provide a strong source to move 3120X4 load to the 3120X3.

Project Objectives

The short-term objective is to address the overloaded step on Middle Winchendon Road. This project will reduce the load by more than half on that step. It is also important to get a stronger source further down Route 202. This is the commercial area for the town of Rindge. It is also the major road from Massachusetts into the town. There is already a Walmart, Market Basket, and Hannaford's just a half mile up the street from this location along with about a dozen other national small retailers and fast food restaurants.

Lake Monomonac is located on the state border. Many summer cottages have turned into year-round premium homes. The lake is on the 3120X4 circuit as is most of the town of Rindge. We need to begin pulling load onto the 3120X3 to relieve some of the loaded up single phase radials that feed this corner of the town.

Project Scope

This project is to extend three-phase 1/0 spacer cable from pole 149/28 on Route 202 near Rand Road to pole 37/92 near Forristall Road. The existing 18 – 40 foot poles will be replaced with 50 foot poles. A 333 kVA, 19.9/7.2 kV step will be installed at the beginning of Forristall Road. The line will be opened where Middle Winchendon Road meeting Route 202. The line heading south on Route 202 will be converted 4,000 feet to pole 37A/23. There is just one overhead transformer to be changed and a couple of insulators to upgrade.

Background / Justification

Rindge is growing. There is a need to move load from the constrained 3120X4 to the 3120X3. This is a way to build another strong source into the area for this existing load and the anticipated growth along a major route into Massachusetts.

Business Process and / or Technical Improvements

The new construction will be to current standards and utilize three phase spacer cable.

Alternatives Considered with Cost Estimates

A single-phase upgrade was considered. This would have met short term concerns but would not have met longer term objectives for the area.



Project Schedule

Milestone/Phase Name	Estimated Date
100% Engineering Completion	
Construction Start	
In Service Date	

Regulatory Approvals

Eversource has already acquired NHDOT permits for setting poles along this limited access highway.

Risks and Risk Mitigation Plans

Limited risk.

Contingency

There is \$31,000 in local project oversight and contingency on this project.

References

None.

Cost Estimate Backup Details

This project was originally written in STORMS assuming using internal resources for construction. The price for this job was estimated at \$98,738. The local AWC was not able to meet the resource needs of this project and it has been bid out to contractors



Attachments (One-Line Diagrams, Images, etc.)

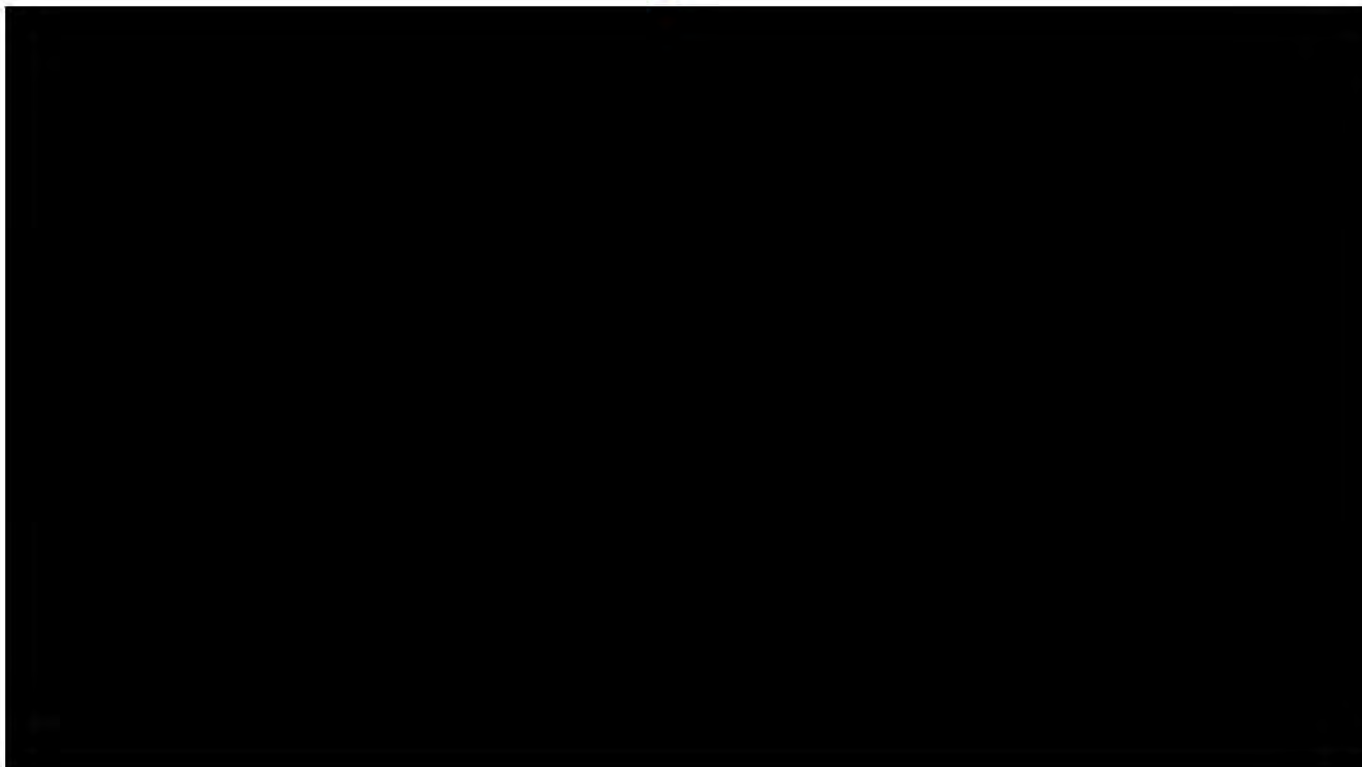

REDACTED



Current Circuit Backbones – 3120X3 and 3120X4

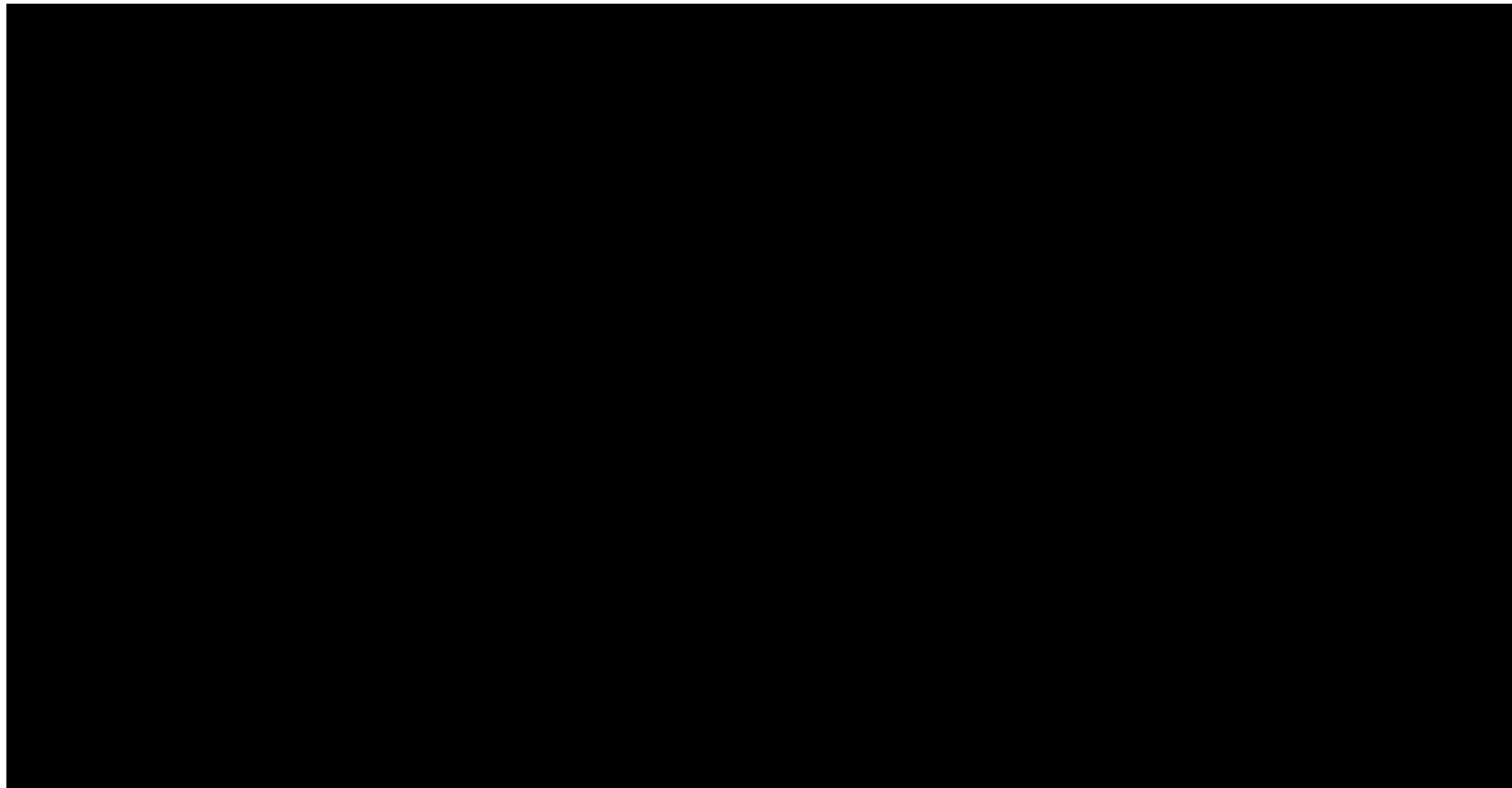

REDACTED
EVERSOURCE
Project Authorization Form

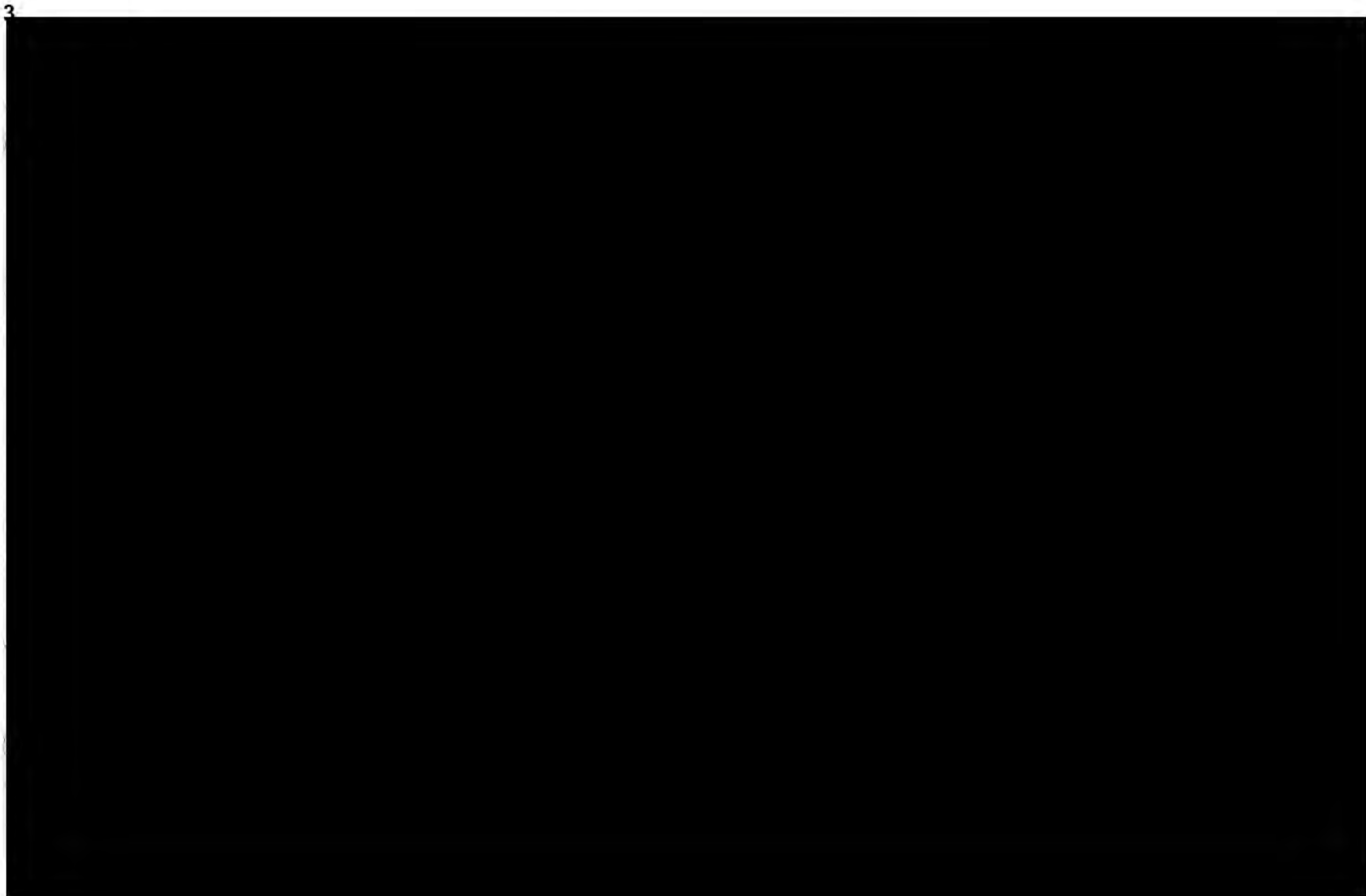

REDACTED



3120X4

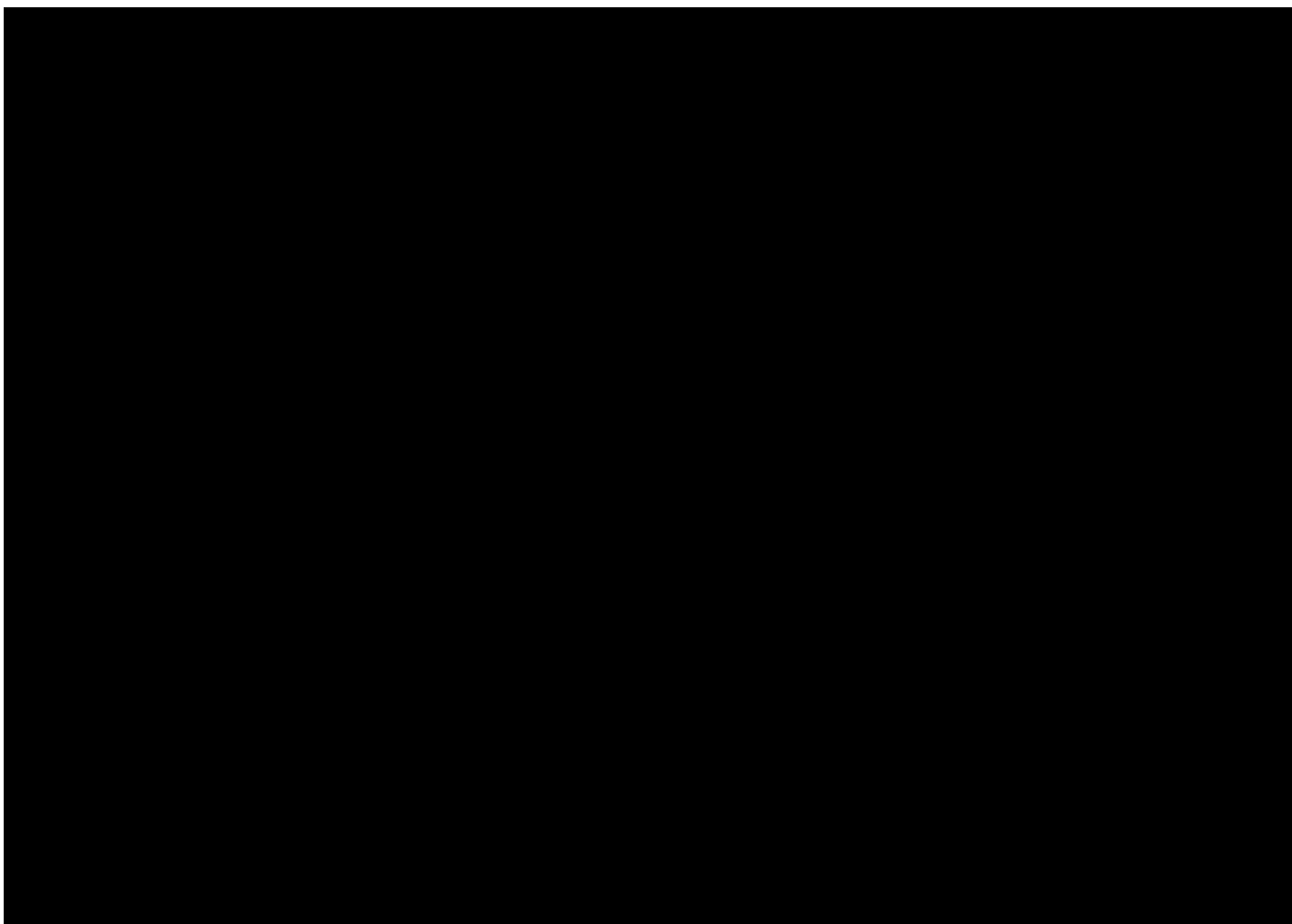



Operations Project Authorization Form

Date Prepared: 12/11/2020	Project Title: PCB Transformer Replacement Program
Company/ies: Eversource NH	Project ID Number: CO1PCB
Organization: NH Operations	Class(es) of Plant: Distribution
Project Initiator: Pat Sullivan	Project Category: Basic Business - Environmental
Project Manager: Pat Sullivan	Project Type: Specific Annual Program
Project Sponsor: Mark Sandler	Project Purpose: PCB Transformer Replacement
Estimated in service date: 12/31/2021	If Transmission Project: PTF? NA
Eng. /Constr. Resources Budgeted? Yes	Capital Investment Part of Original Operating Plan? Yes
Authorization Type: Full Funding	Facility Type (check all that apply):
Total Request (Gross): \$140,000	<input type="checkbox"/> PTF <input type="checkbox"/> non-PTF <input checked="" type="checkbox"/> Distribution

Financial Requirements:

Project Authorization

ERM: _____

FP&A: _____

Executive Summary

An approval of \$140K is requested for the 2021 PCB Transformer Replacement program. The specific work is not identified during the budget cycle but is a result of monitoring the system throughout the year. Prior to 1978, polychlorinated biphenyls (PCBs) were used in transformers as a fire retardant, but were later identified as being detrimental to the environment and to humans and were banned in the late 1970s. Eversource has had a program each year to change out transformers on the system identified as potentially PCB contaminated and will continue to change out the suspect transformers on the system until they are all gone. The plan for 2021 is to remove 50 units from the system.

Project Costs Summary *Note: Dollar values are in thousands*

Line item Category	Prior Authorized	Actuals to Date	2020 to Go	2021	2022	2023	2024	2025	Total
1. ROW / Easements / Land Acquisition	\$0	\$0	\$0	\$0	\$0	\$0	\$0	\$0	\$0
2. Environmental Approvals / Permits	\$0	\$0	\$0	\$0	\$0	\$0	\$0	\$0	\$0
3. Outreach	\$0	\$0	\$0	\$0	\$0	\$0	\$0	\$0	\$0
4. Siting Approvals / Permits	\$0	\$0	\$0	\$0	\$0	\$0	\$0	\$0	\$0
5. Engineering / Design	\$0	\$0	\$0	\$0	\$0	\$0	\$0	\$0	\$0
6. Materials (Eversource purchased)	\$0	\$0	\$0	\$11	\$0	\$0	\$0	\$0	\$0
7. Construction (incl mat'l's by contractors)	\$0	\$0	\$0	\$63	\$0	\$0	\$0	\$0	\$74
8. Testing / Commissioning	\$0	\$0	\$0	\$0	\$0	\$0	\$0	\$0	\$0
9. Project Mgmt Team	\$0	\$0	\$0	\$0	\$0	\$0	\$0	\$0	\$0
10. Removals	\$0	\$0	\$0	\$0	\$0	\$0	\$0	\$0	\$0
11. Other	\$0	\$0	\$0	\$0	\$0	\$0	\$0	\$0	\$0
12. Risks	\$0	\$0	\$0	\$0	\$0	\$0	\$0	\$0	\$0
SUBTOTAL DIRECTS W/ RISKS	\$0	\$0	\$0	\$74	\$0	\$0	\$0	\$0	\$74
13. Indirects/Overhead	\$0	\$0	\$0	\$66	\$0	\$0	\$0	\$0	\$66
14. AFUDC	\$0	\$0	\$0	\$0	\$0	\$0	\$0	\$0	\$0
PROJECT TOTAL - BASELINE BUDGET	\$0	\$0	\$0	\$140	\$0	\$0	\$0	\$0	\$140
15. Contingency	\$0	\$0	\$0	\$0	\$0	\$0	\$0	\$0	\$0
TOTAL CAPITAL REQUEST	\$0	\$0	\$0	\$140	\$0	\$0	\$0	\$0	\$140
16. Reimbursables/Customer Contribution	\$0	\$0	\$0	\$0	\$0	\$0	\$0	\$0	\$0
PROJECT TOTAL (LESS REIMBURSABLES)	\$0	\$0	\$0	\$140	\$0	\$0	\$0	\$0	\$140
O&M	\$0	\$0	\$0	\$0	\$0	\$0	\$0	\$0	\$0
TOTAL REQUEST	\$0	\$0	\$0	\$140	\$0	\$0	\$0	\$0	\$140

Note: Explain unique payment provisions, if applicable: *Provide a detailed breakdown of Other costs here.*



Breakout Costs

Note: Dollar values are in thousands

Line item Category	Prior Authorized	Actuals to Date	2020 to Go	2021	2022	2023	2024	2025	Total
ST Labor	\$0	\$0	\$0	\$23	\$0	\$0	\$0	\$0	\$23
OT Labor	\$0	\$0	\$0	\$0	\$0	\$0	\$0	\$0	\$0
Outside Services Labor	\$0	\$0	\$0	\$40	\$0	\$0	\$0	\$0	\$40
Materials*	\$0	\$0	\$0	\$11	\$0	\$0	\$0	\$0	\$11
Removals	\$0	\$0	\$0	\$0	\$0	\$0	\$0	\$0	\$0
Other	\$0	\$0	\$0	\$0	\$0	\$0	\$0	\$0	\$0
Indirects	\$0	\$0	\$0	\$66	\$0	\$0	\$0	\$0	\$66
AFUDC	\$0	\$0	\$0	\$0	\$0	\$0	\$0	\$0	\$0
TOTAL CAPITAL REQUEST - W/O REIMBURSABLES	\$0	\$0	\$0	\$140	\$0	\$0	\$0	\$0	\$140

*All materials including Eversource purchased and outside service purchased. Note that outside service purchased material included in construction in project cost summary above.



Future Financial Impacts:

Provide below the estimated future costs that will result from the project:

Note: Dollar values are in thousands

Future Costs	Year 20__	Year 20__	Year 20__	Year 20__ +	Total Future Project Costs
Capital	\$ -	\$ -	\$ -	\$ -	\$ -
O&M	-	-	-	-	-
Other	-	-	-	-	-
TOTAL \$	-	\$ -	\$ -	\$ -	\$ -

Describe the estimated future Capital, O&M, and/or Other costs noted above:

What functional area(s) will these future costs be funded in? _____

A representative from the respective functional area is required to be included as a project approver.

Provide below the estimated future financial benefits that will result from the project:

Note: Dollar values are in thousands

Future Benefits	Year 20__	Year 20__	Year 20__	Year 20__ +	Total Future Project Benefits
Capital	\$ -	\$ -	\$ -	\$ -	\$ -
O&M	-	-	-	-	-
Other	-	-	-	-	-
TOTAL \$	-	\$ -	\$ -	\$ -	\$ -

Describe the estimated future Capital, O&M, and/or Other benefits noted above:

What functional area(s) will these benefits be reflected in? _____

A representative from the respective functional area is required to be included as a project approver.

Asset Retirement Obligation (ARO) and/ or Environmental Cleanup Costs (Environmental Liabilities):

Is there an ARO associated with this project? No

Are there other environmental cleanup costs associated with this project? No.

EVERSOURCE

Project Authorization Form

Technical Justification

Project Need Statement

Capital funding is needed to address replacement of transformers identified as potentially contaminated with polychlorinated biphenyls (PCBs).

Project Objectives

Replacement of transformers containing PCBs.

Project Scope

Approval of the PCB Transformer Replacement (CO1PCB) project covers authorization of all area work center PCB transformer replacement work orders. The CO1PCB program encompasses the total NH PCB transformer replacement program budget. Actual charges will accumulate in the individual area work center work orders.

Background / Justification

This is a project for the Replacement of PCB contaminated transformers to remove them from the Eversource system.

Business Process and / or Technical Improvements:

Not applicable.

Alternatives Considered with Cost Estimates

Not applicable.

Project Schedule

Milestone/Phase Name	Estimated Completion Date
Program completion	12/31/2021

Regulatory Approvals

The construction budget is submitted to the New Hampshire Public Utilities Commission in accordance with Rule Puc 308.07 using Form E-22. Also on a quarterly basis projects not previously reported in the annual construction budget that have exceeded \$100,000 are reported to the New Hampshire Public Utilities Commission.

Risks and Risk Mitigation Plans

On a monthly basis, capital project spending is reviewed and any risks are identified and managed during that meeting.

References

Not applicable.

Attachments (One-Line Diagrams, Images, etc.)

Not applicable.

Cost Estimate Backup Details

2021 program funding levels were estimated using historical spending.